

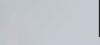

Polyurethane **BELTS**

ela
tech
Elatech

Technology in Motion.

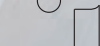
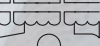
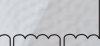
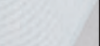
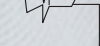
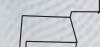
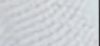
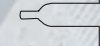
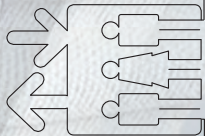

ELATECH® Polyurethane Belts	2
ELATECH® Company Profile	2 - 3
Introduction to ELATECH® polyurethane belts	4
Product range	4
Material characteristics	5 ÷ 7
ELATECH® M and V	9
Introduction	10
Product certification	10
Tension cords	10
Mechanical and chemical properties	10
Executions and ordering examples	11
Technical data	
• Metric profile T, AT, ATL	12 ÷ 35
• Inch pitch profile MXL, XL, L, H, XH	36 ÷ 45
• HTD profile and HTD profile high load XHPL	46 ÷ 55
• RTD and STD profile	56 ÷ 71
• EAGLE profile - Self tracking timing belts TK and ATK	72 ÷ 83
• Total Protection belts (T10TP - AT10TP - HTD8M TP)	84 ÷ 89
• Flat belts, Flat belts Heavy Series and Poly-V	90 ÷ 95
• 10 TT5	96
Clamping plates	97
ELATECH® SYNCRO-MAX™ - Extra-Wide	99
Introduction	100
Technical data	
• Metric profile T10	101
• Inch pitch profile H	102
ELA-flex SD™ Polyurethane Belts	103
Introduction	104
Tolerances and tension cords	104
Double sided timing belts	104
Product certification	104
Belt designation	104
Technical data	
• Metric profile T and AT	105 ÷ 111
• Inch pitch profile XL, L, H, XH	112 ÷ 115
• HTD profile	116 ÷ 118
• RTD and STD profile	119 ÷ 124
• EAGLE profile and Self tracking timing belts ATK10	125 ÷ 129
• Flat belts	130 ÷ 131
ELATECH® iSync™ High Performance Timing Belts	133
Introduction	134
Tension cords	134
Standard belt sizes - Single Toothing	135 - 136
Standard belt sizes - Dual Toothing	136
Special belts	136
Technical data	
• Metric profile T	137 ÷ 139
• Metric profile AT	140 ÷ 141
• Inch pitch profile L	142
Polyurethane Belts for Conveying Applications	143
Belts with backings	144
• Fabric	145
• Cellular	146
• PVC and PU	147
• Rubber	148
• Special	149
EMF - Mechanical Fastening System	150 - 151
EFT - False Tooth System	152
Mechanical processing	153
Belts with profiles	154
ELACLEATS - download in CAD or PDF format the most suitable cleats	155 - 156
Drive Calculation	157
Guidelines	158
Belt installation	159
ELADRIVE - on line calculation software	160
• LINEAR - Drive Calculation	161 ÷ 165
• LINEAR - Selection Graphs	166 ÷ 175
• ELA-Flex SD™ and iSync™ - Drive Calculation	176 - 177
• ELA-Flex SD™ and iSync™ - Selection Graphs	178 ÷ 180
Troubleshooting	181

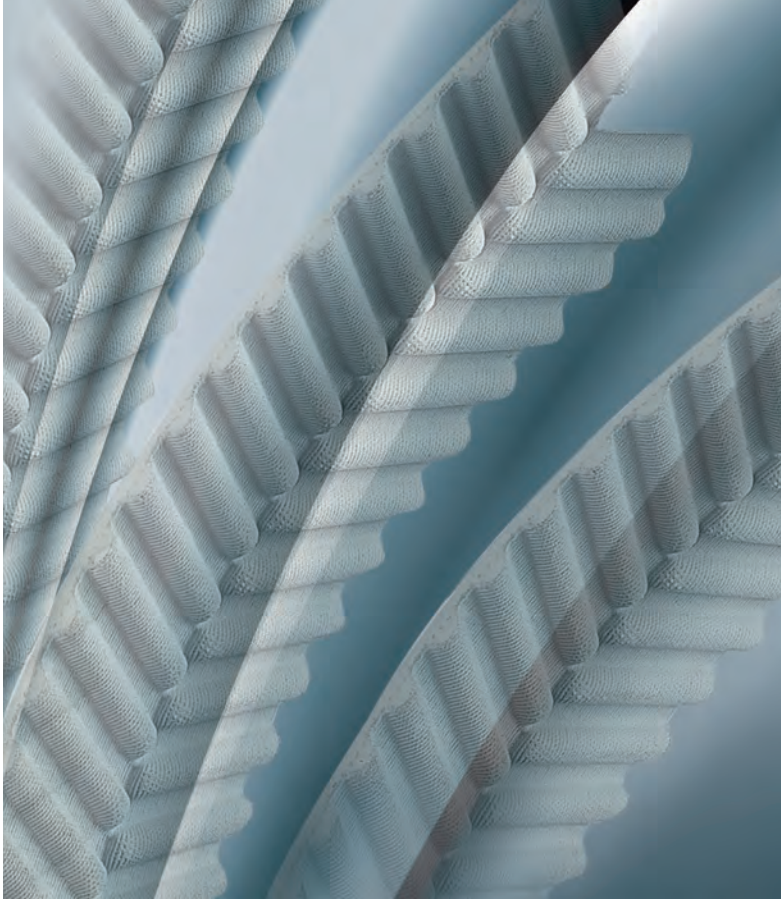

ELATECH® is a Company fully dedicated to the research, development and manufacture of polyurethane belts for industrial applications.

The unique manufacturing processes, made possible with the newest generation of technologies, the modern and efficient test and control equipment and a unique team of qualified technicians and engineers, allow **ELATECH®** to offer superior products with highest flexible service.

Global Presence

With 5 sister Companies on 3 continents and a wide range of qualified distributors, **ELATECH®** guarantees superior technical and delivery service worldwide.

Our Mission

Constantly growing, together with our customers, in product and process innovation to develop the best polyurethane belt for every industrial application.



Designed for **Performance**,
Engineered for **Excellence**

Research & Development



We strongly believe innovation is the key to success for our Customers. We are totally committed to quality and close cooperation with our customers to solve the problems of design engineers in the most advanced and economical way.

Our qualified technicians and our advanced test laboratory with the most modern resources allow us to offer the most effective solutions in all conveying, lifting or power transmission applications.

Total Quality

In **ELATECH**[®] the term "quality" is not only limited to the product. We offer professional and competent consulting services with fast and reliable deliveries. The certification of our quality system confirms the quality consciousness of our Company and of all our employees. Our management system is certified according to ISO 9001:2008.



Introduction

ELATECH® manufactures polyurethane belts for linear motion, conveying, lifting and power transmission applications. The combination of a polyurethane body reinforced with special steel or aramid tension members, allows the belt to fulfil the most severe requirements in all industrial applications.

The unique manufacturing processes developed with the newest generation technologies such as test and control equipment, give us the ability to deliver superior products with the highest flexibility of service.

ELATECH® offers the widest range of tooth profile to enable the design engineer the use of the best drive for every application.

In addition to that, for special applications, ELATECH® studies and delivers innovative and unique solutions for even the most complex requirements.

Product range

ELATECH® M - open end

ELATECH® M belts are produced in standard roll length of 100 m and delivered to any desired length. The excellent precision and dimensional stability and the high abrasion resistance make them ideal in all linear motion applications.

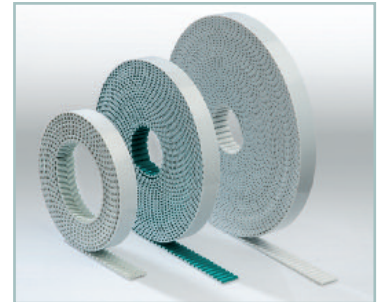

ELATECH® V - jointed

They are jointed belts obtained from open-end belts. The special manufacturing process, allows for obtaining any desired length. Due to the high flexibility and to the unique precision in positioning offered, ELATECH® V belts are ideal for all conveying applications where synchronisation is needed. ELATECH® V have been designed specifically for transport applications with linear speeds up to 2 m/s. They can not be used for power transmission applications.

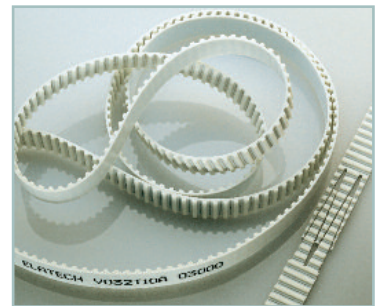

ELA-flex SD™

ELA-flex SD™ Synchro Drive belts are manufactured with truly endless steel tension cords. Having no splice or welding, they have no weak cross section and are therefore ideal for power transmission and high load conveying applications. They are available in a wide range of profiles and pitches and in any length tooth by tooth from **800 mm to 20000 mm**.



iSync™

ELATECH® iSync™ belts are made with a special polyurethane compound and high resistance steel tension cords which are processed with a unique and highly sophisticated technology to obtain a superior polyurethane belt. iSync™ belts offer optimal performances on all type of industrial applications and particularly where high precision and accuracy are needed.

iSync™ belts are able to transmit up to 30% more than conventional T, AT type of belts in the same space or same power with a more compact drive.



Material characteristics

ELATECH® belts are manufactured as standard in thermoplastic polyurethane 92 Sh. A hardness. Non standard material and compounds are available for applications in special environments or for special specifications. Standard colour, unless differently specified, is white. Other colours are available upon request.

Resistance to oils

ELATECH® polyurethane has a high resistance to most oils. The following graph compares synthetic rubber CR and NBR with ELATECH® polyurethane.

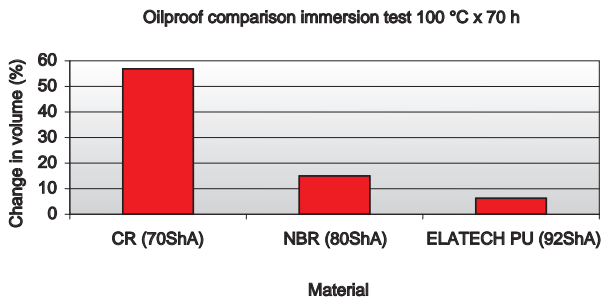

Abrasion resistance

ELATECH® polyurethane has excellent abrasion resistance properties. The graph below shows comparison with synthetic rubber.

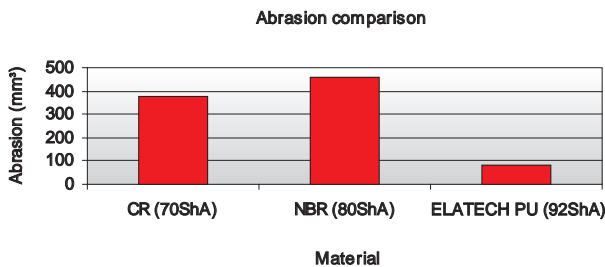

FDA/USDA approval

Standard material is not FDA approved. For applications where FDA approval is required, a special material will be used. The standard colour of the FDA material is transparent. Material code U-FDA.

Chemical resistance

The impact of chemicals on ELATECH® polyurethane results in different modification of the material's properties. As the resistance mainly depends on the concentration and the temperatures used, the information provided can only be general. If further detailed information is required please contact our technical department.

Oil and Grease

ELATECH® polyurethane is well-resistant to oil and grease and specifically to pure oils even at 80°C.

Acids and alkaline solutions

The resistance to acids and alkaline solutions of the ELATECH® polyurethane is limited. It has shown to be moderately resistant to diluted acids and alkaline solutions at room temperature and to be resistant for a very short time with high concentration solutions. Special compounds are available on specific request.

Bacteria and microbes

In case of high exposure to microbe attack it is recommended to use a special material. Please contact our technical department.

UV resistance

ELATECH® polyurethane is UV resistant. A long exposure to UV radiation (sunlight) will slightly change the color of the belt. However the technical performances of the product will remain unchanged.

Low temperature compound

For low temperature use special compound (-30 +5 °C). U-LT can be supplied.

High temperature compound

For high temperature use special compound (+20 +110 °C). U-HT can be supplied.

Chemical resistance

Chemical reference	0/40° C	40/80°C
Acetic acid 20%	B	C
Acetic acid 3 n	C	C
Acetic acid 5%	B	C
Acetone	C	C
Alluminium chloride aqueous , 5%	A	-
Ammonia 10%	A	-
Amyl acetate	C	C
Amylum	A	A
Aniline	B	C
ASTM fuel A	A	-
ASTM Fuel B	A	-
ASTM Fuel C	B	-
Benzene	B	C
Blood	A	B
Brine	A	B
Butyl acetate	C	-
Butyl alcohol	B	B
Butter	A	A
Butyric acid	B	B
Chloro benzene	C	C
Chloroform	B	B
Cyclohexanol	B	B
Cyclohexanone	C	C
Dibutylphthalate	B	-
Dimethylformamide	D	-
Diocetyl phthalate	A	A
Ethanol	B	C
Ethanol 96%	B	-
Ethylene glycol	A	B
Ethyl acetate	C	C
Ethylene dichloride	B	B
Ethylether	B	C
Fat (animal)	A	A
Fe chloride , 5%	B	C
Formalin	B	C
Freon 22	B	C
Fructose	A	A
Fruit juice	A	A
Gasoline	A	-
Gelatin	A	A
Glycerin (glycerol)	B	C
Glystantin / water 1:1	B	-
Honey	A	B
Hydrochloric acid 20%	B	-
Hydrogen	A	-
Ink	B	B
Isopropanol	B	-
Kerosene	A	B

Chemical reference	0/40° C	40/80°C
Lactic acid	B	C
Liqueur	A	B
Margarine	A	A
Methyl ethyl ketone (MEK)	C	-
Methyl alcohol (methanol)	B	C
Methyl chloride	D	-
Milk	A	A
Molasses	A	A
Nicotine	A	-
Nitric acid 20%	D	-
Oil animal	B	B
Oil ASTM 1	A	A
Oil ASTM 2	A	A
Oil ASTM 3	A	A
Oil heavy	A	B
Oil light	A	B
Oil Machine	B	B
Oil mineral	A	B
Oil tar	B	B
Oil turpentine	B	B
Oil vegetable (peanut , pine ,...)	A	A
Oleic acid	B	-
Ozone	A	A
Paraffin	B	B
Petrol, premium grade	C	-
Petrol, standard grade	A	-
Petroleum ether	B	C
Sea water	B	B
Silicone grease	A	A
Soap	A	B
Sodium carbonate	A	-
Sodium chloride solution	A	B
Sodium hydroxide solution 1N	B	C
Styrene	B	C
Sugar	A	A
Sulphuric acid 20%	B	C
Tannic acid	A	B
Tetrachloroethylene	C	C
Tetrahydrofuran	D	-
Toluene	B	C
Trichloroethylene	C	C
Triocetyl phosphate (TPC)	B	C
Vaseline	A	A
Water	A	B
Water oxygenated	B	B
Water soapy	A	B
Wax	A	A
Yeast	A	B

Note

- The above table is valid for material to be conveyed containing chemicals and or oil. In case of immersion, please contact our technical department.
- It must be considered that alkalis, acids, peroxides, water and water solutions may corrode the steel tension member. Please contact our technical department for solutions.

A = resistant over a prolonged period

B = conditionally resistant, after a certain time appreciable differences are possible

C = not resistant, short-term contact possible

D = not resistant, pronounced attack

Material overview

Materials for standard applications

Material type	Belt Type	Color	Hardness	Temperature range	Tension member
TPU11	ELATECH® M ELA-flex SD™	White	92 Sh A	-10°C +80°C	A - Steel cord S - Stainless steel cord K - Aramid cord
TPU13	ELATECH® M ELA-flex SD™	Black	92 Sh A	-10°C +80°C	A - Steel cord S - Stainless steel cord K - Aramid cord
TPU12	ELATECH® M ELA-flex SD™	Transparent	92 Sh A	-10°C +80°C	A - Steel cord S - Stainless steel cord K - Aramid cord
TPU22	ELATECH® M ELA-flex SD™	Transparent	85 Sh A	0°C +60°C	A - Steel cord S - Stainless steel cord K - Aramid cord
PU51	iSync™	Transparent	90 Sh A	-10°C +80°C	A - Steel cord S - Stainless steel cord K - Aramid cord

Materials for applications involving contact with food - FDA approved materials

Material type	Belt Type	Color	Hardness	Temperature range	Tension member
TPU17	ELATECH® M ELA-flex SD™	Transparent	92 Sh A	0°C +80°C	S - Stainless steel cord K - Aramid cord
TPU16	ELATECH® M ELA-flex SD™	White	92 Sh A	0°C +80°C	S - Stainless steel cord K - Aramid cord
TPU19	ELATECH® M ELA-flex SD™	Light blue	92 Sh A	0°C +80°C	S - Stainless steel cord K - Aramid cord
PU52	iSync™	Transparent	90 Sh A	0°C +80°C	S - Stainless steel cord K - Aramid cord

Materials for high temperature applications

Material type	Belt Type	Color	Hardness	Temperature range	Tension member
TPU32	ELATECH® M ELA-flex SD™	White	92 Sh A	-20°C +110°C	A - Steel cord S - Stainless steel cord
PU53	iSync™	Transparent	90 Sh A	-20°C +125°C	A - Steel cord S - Stainless steel cord

Materials for low temperature applications

Material type	Belt Type	Color	Hardness	Temperature range	Tension member
TPU18	ELATECH® M ELA-flex SD™	Transparent	92 Sh A	-30°C +80°C	A - Steel cord S - Stainless steel cord K - Aramid cord
PU54	iSync™	Transparent	90 Sh A	-30°C +80°C	A - Steel cord S - Stainless steel cord K - Aramid cord

Materials for applications where antistatic properties are required - Static conductive materials

Material type	Belt Type	Color	Hardness	Temperature range	Tension member
TPU13C	ELATECH® M ELA-flex SD™	Black	92 Sh A	-10°C +80°C	A - Steel cord S - Stainless steel cord K - Aramid cord

ELATECH® M and V

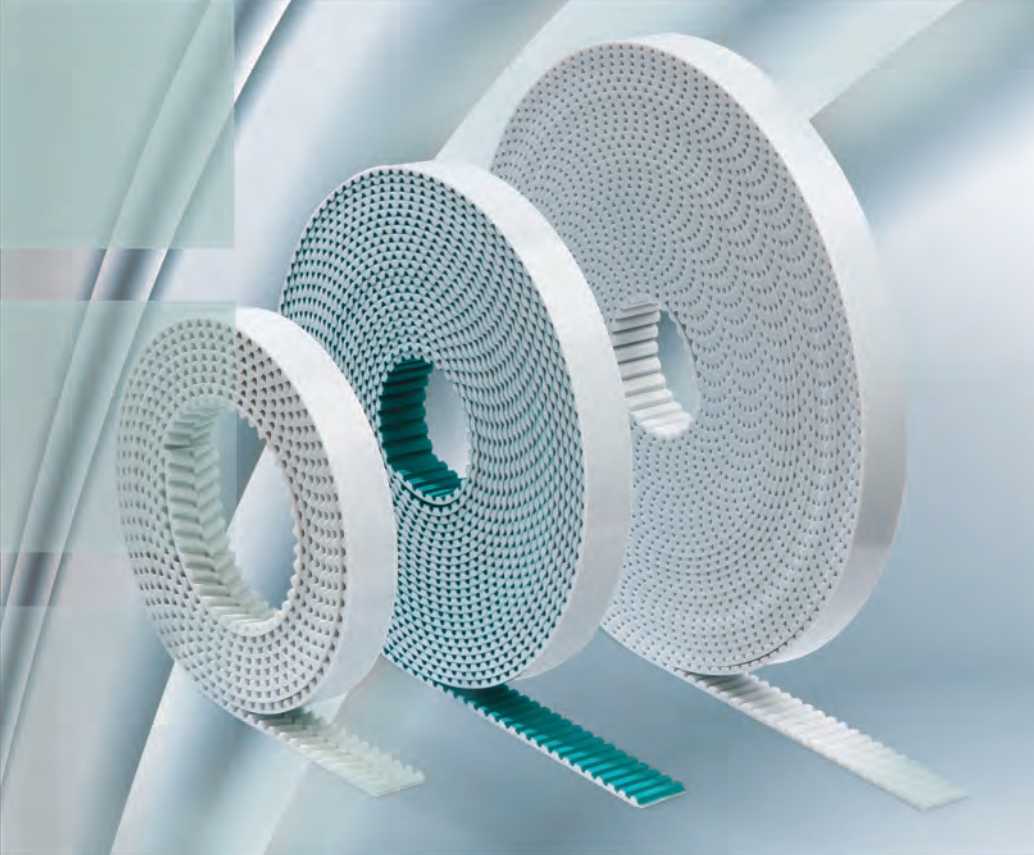

Technology in Motion.

The timing belts manufactured by ELATECH® have been designed to comply with every need of the design engineer in linear motion, power transmission and in conveying applications where precise synchronisation is needed. ELATECH® timing belts are manufactured with the body in thermoplastic polyurethane with excellent wear resistance and with high tensile strength steel cords. A special polyamide fabric on the tooth (on request) reduces the coefficient of friction, improves the tooth engagement and reduces noise.

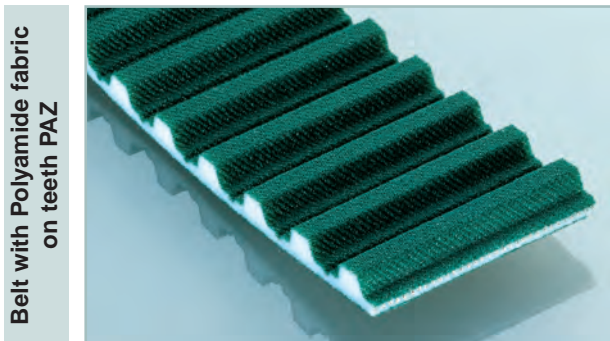

Product certification

- ELATECH® belts are certified to be according RoHS 2002/95/EC
- On request, it is possible to deliver belts:
 - according to 94/9/CE ATEX II2G-22D
 - with antistatic properties

Colour

The standard colour ELATECH® timing belt is white. On demand it is possible to deliver belts in different colours.

Tension Cords

In order to maximize the application of ELATECH® timing belts, construction with special cords is available on request:



- **HPL** high performance cords: the cord cross section is increased compared with standard. This results in a lower belt elongation and more precise positioning accuracy.
- **HFE** high Flexibility cords: the cord cross section is spread on a higher number of single filaments. This results in a lower bending stress and therefore in a higher resistance at reverse bending of the cords. They allow using pulleys and idlers up to 30% smaller in diameter compared to standard.
- **INOX** stainless steel cords are suitable for application in aggressive environments. They have lower tensile strength than standard cords.
- **ARAMID**: increases belt flexibility and decreases belt weight.

It is to be noted that steel cords offer the best technical performances and dimensional stability of the belts.

Belt length tolerances are valid for steel cord reinforcement. In case of other material (aramid, fibreglass) length tolerance may change.

For application with special cords ask our engineering department.

Mechanical properties:

- Excellent dimensional stability
- High abrasion resistance
- Low pretension and shaft load
- Maintenance free
- High linear and angular positioning precision
- High efficiency

Chemical properties:

High resistance to:

- Hydrolysis
- Ozone
- UVA
- Ageing
- Oils, greases and fats
- Gasoline
- Good resistance to acids
- Working temperatures range for standard material -10°C +80°C (peaks up to 110°C). For very low temperature special compound material is available on request (see dedicated table)
- Silicon free production

Executions

ELATECH® M

They are manufactured in rolls with standard length of 100 m. On request longer or shorter lengths are available. Main applications are linear drives.

Ordering example T :

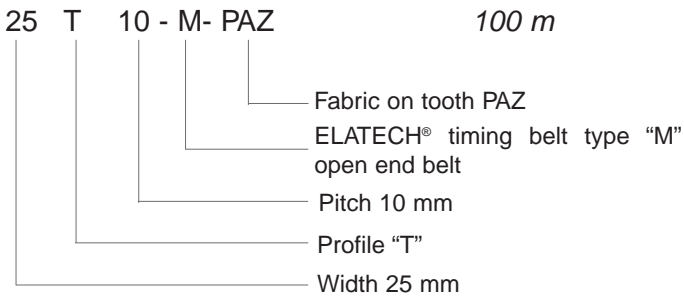

Ordering example H :

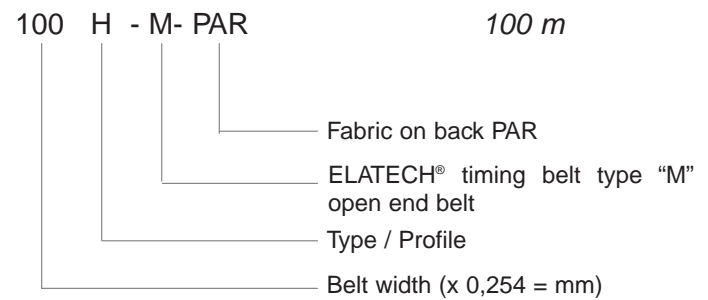

Ordering example HTD cut to length:

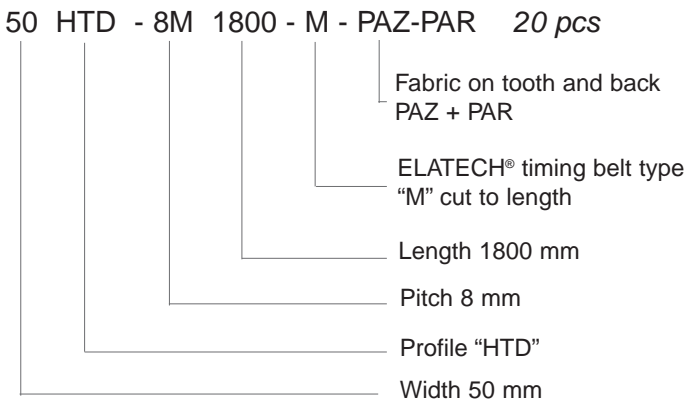

Ordering example H cut to length:

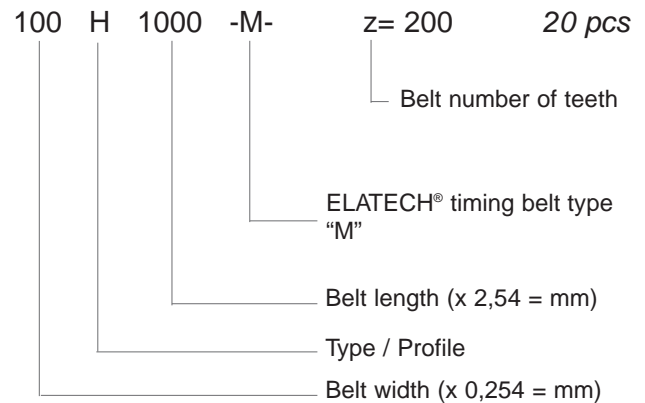

ELATECH® V

They are jointed belts manufactured from open-end ELATECH® belts. Thanks to the specific manufacturing process, any length may be obtained tooth by tooth with a minimum of 800 mm length. Free combinations with special backing materials and welded profiles, make ELATECH® V belts ideal in synchronized conveying and highly specialised applications.

Ordering example AT :

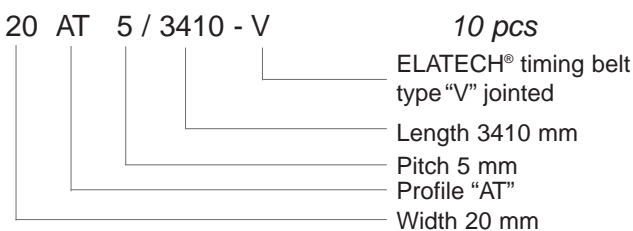

Ordering example XL :

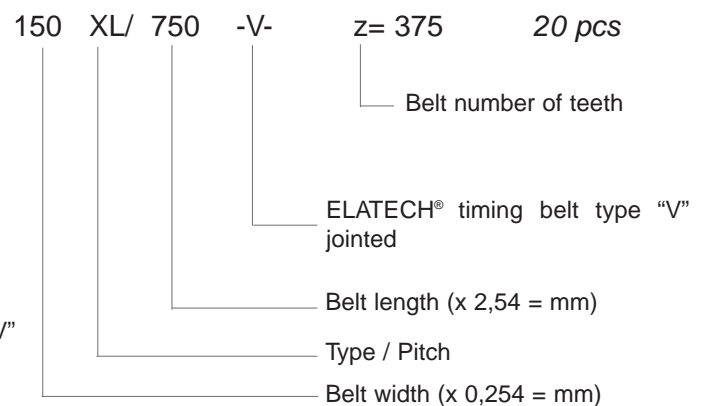

Ordering example STD :

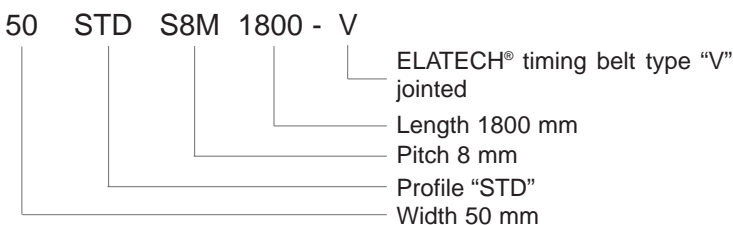

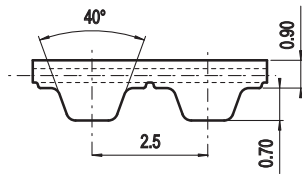

Belt characteristics

- Polyurethane timing belt with steel tension cords
- Trapezoidal tooth profile according to DIN 7721 T1
- Metric pitch 2,5 mm
- Ideal for drives where high belt flexibility is requested
- Widely used for conveying, linear drive and light power transmission applications
- Color: white

- Width tolerance: $\pm 0,5$ [mm]
- Length tolerance: $\pm 0,5$ [mm/m]
- Thickness tolerance: $\pm 0,2$ [mm]

Technical Data

Belt width b [mm]	Allowable tensile load Type M F_{Tzul} [N]	Allowable tensile load Type V F_{Tzul} [N]	Breaking load Type M F_{Br} [N]	Specific spring rate C_{spez} [N]	Weight [kg/m]
4	130	65	500	32500	0,004
6	190	95	750	47500	0,007
10	320	160	1250	80000	0,011
20	700	350	2750	175000	0,022
50	1860	930	7250	465000	0,055
100	3780	1890	14750	945000	0,110

Other widths are available on request.

Load / Elongation [%]

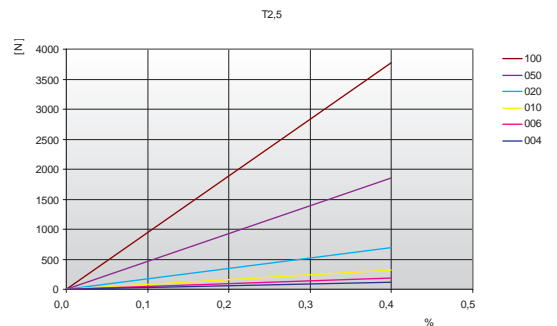

Tooth shear strength

rpm	F_{Uspez} [N/cm]	rpm	F_{Uspez} [N/cm]	rpm	F_{Uspez} [N/cm]	rpm	F_{Uspez} [N/cm]
0	9,10	700	6,13	1800	5,11	4000	4,22
20	8,77	800	5,99	1900	5,05	4500	4,09
40	8,51	900	5,86	2000	4,99	5000	3,97
60	8,30	1000	5,75	2200	4,88	5500	3,86
80	8,13	1100	5,64	2400	4,79	6000	3,76
100	8,00	1200	5,55	2600	4,70	6500	3,67
200	7,39	1300	5,46	2800	4,62	7000	3,59
300	7,00	1400	5,38	3000	4,54	7500	3,51
400	6,71	1440	5,35	3200	4,47	8000	3,44
500	6,48	1500	5,31	3400	4,40	8500	3,37
600	6,29	1600	5,24	3600	4,34	9000	3,30
700	6,13	1700	5,17	3800	4,28	10000	3,18

Tooth shear strength / rpm

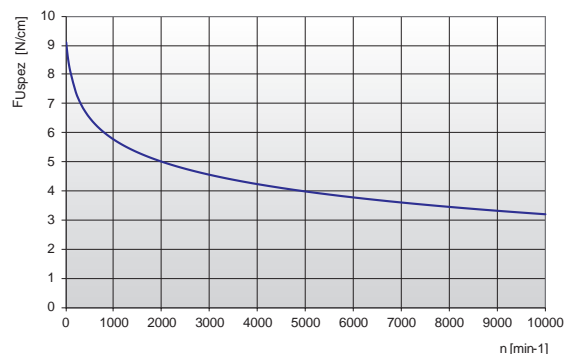

The specific load F_{Uspez} is the maximum load which one single belt tooth 1 cm wide can withstand in all operating conditions.

This force is related to the drive rpm.

The total load F_u transmissible by the belt in the drive is calculated by:

$$F_u [N] = F_{Uspez} \cdot Z_e \cdot b$$

- F_u [N] = peripheral force
- F_{Uspez} [N/cm] = specific load
- Z_e = number of teeth in mesh in the small pulley
- Z_{emax} = max. no of teeth in mesh to be considered for the calculation of the drive
- Z_{emax} = 12 for ELATECH® M
- Z_{emax} = 6 for ELATECH® V
- b [cm] = belt width in cm

Flexibility

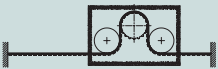
Minimum pulley number of teeth and minimum idler diameter		Type of cord
		STANDARD
Drive without reverse bending 	Timing pulley z_{min}	15
	Flat idler running on belt teeth d_{min}	15 mm
Drive with reverse bending 	Timing pulley z_{min}	18
	Flat idler running on belt back d_{min}	18 mm

Timing pulleys

Z	da	dw	Z	da	dw	Z	da	dw	Z	da	dw
10	7,46	7,96	43	33,72	34,22	76	59,98	60,48	109	86,24	86,74
11	8,25	8,75	44	34,52	35,02	77	60,78	61,28	110	87,04	87,54
12	9,05	9,55	45	35,31	35,81	78	61,57	62,07	111	87,83	88,33
13	9,85	10,35	46	36,11	36,61	79	62,37	62,87	112	88,63	89,13
14	10,64	11,14	47	36,90	37,40	80	63,16	63,66	113	89,43	89,93
15	11,44	11,94	48	37,70	38,20	81	63,96	64,46	114	90,22	90,72
16	12,23	12,73	49	38,49	38,99	82	64,76	65,26	115	91,02	91,52
17	13,03	13,53	50	39,29	39,79	83	65,55	66,05	116	91,81	92,31
18	13,82	14,32	51	40,09	40,59	84	66,35	66,85	117	92,61	93,11
19	14,62	15,12	52	40,88	41,38	85	67,14	67,64	118	93,40	93,90
20	15,42	15,92	53	41,68	42,18	86	67,94	68,44	119	94,20	94,70
21	16,21	16,71	54	42,47	42,97	87	68,73	69,23	120	95,00	95,50
22	17,01	17,51	55	43,27	43,77	88	69,53	70,03	121	95,79	96,29
23	17,80	18,30	56	44,06	44,56	89	70,33	70,83	122	96,59	97,09
24	18,60	19,10	57	44,86	45,36	90	71,12	71,62	123	97,38	97,88
25	19,39	19,89	58	45,66	46,16	91	71,92	72,42	124	98,18	98,68
26	20,19	20,69	59	46,45	46,95	92	72,71	73,21	125	98,97	99,47
27	20,99	21,49	60	47,25	47,75	93	73,51	74,01	126	99,77	100,27
28	21,78	22,28	61	48,04	48,54	94	74,31	74,81	127	100,57	101,07
29	22,58	23,08	62	48,84	49,34	95	75,10	75,60	128	101,36	101,86
30	23,37	23,87	63	49,64	50,14	96	75,90	76,40	129	102,16	102,66
31	24,17	24,67	64	50,43	50,93	97	76,69	77,19	130	102,95	103,45
32	24,97	25,47	65	51,23	51,73	98	77,49	77,99	131	103,75	104,25
33	25,76	26,26	66	52,02	52,52	99	78,28	78,78	132	104,55	105,05
34	26,56	27,06	67	52,82	53,32	100	79,08	79,58	133	105,34	105,84
35	27,35	27,85	68	53,61	54,11	101	79,88	80,38	134	106,14	106,64
36	28,15	28,65	69	54,41	54,91	102	80,67	81,17	135	106,93	107,43
37	28,94	29,44	70	55,21	55,71	103	81,47	81,97	136	107,73	108,23
38	29,74	30,24	71	56,00	56,50	104	82,26	82,76	137	108,52	109,02
39	30,54	31,04	72	56,80	57,30	105	83,06	83,56	138	109,32	109,82
40	31,33	31,83	73	57,59	58,09	106	83,85	84,35	139	110,12	110,62
41	32,13	32,63	74	58,39	58,89	107	84,65	85,15	140	110,91	111,41
42	32,92	33,42	75	59,18	59,68	108	85,45	85,95			

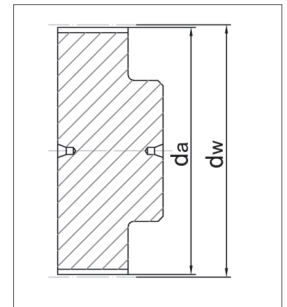

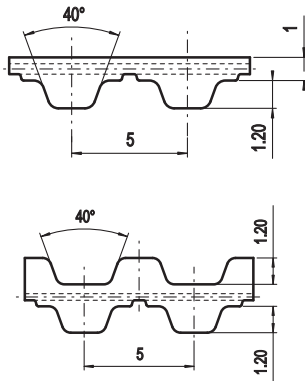

Belt characteristics

- Polyurethane timing belt with steel tension cords
- Trapezoidal tooth profile according to DIN 7721 T1
- Metric pitch 5 mm
- Ideal for drives where high belt flexibility is requested
- Widely used for conveying, linear drive and light power transmission applications
- Double sided tooth construction available

- Width tolerance: $\pm 0,5$ [mm]
- Length tolerance: $\pm 0,5$ [mm/m]
- Thickness tolerance: $\pm 0,2$ [mm]

Technical Data

Belt width b [mm]	Allowable tensile load Type M F_{Tzul} [N]	Allowable tensile load Type V F_{Tzul} [N]	Breaking load Type M F_{Br} [N]	Specific spring rate C_{spez} [N]	Weight [kg/m]
10	320	160	1250	80000	0,021
16	540	270	2125	135000	0,034
25	900	450	3500	225000	0,053
32	1150	575	4500	287500	0,067
50	1860	930	7250	465000	0,105
75	2820	1410	11000	705000	0,158
100	3780	1890	14750	945000	0,210

Other widths are available on request.

Load / Elongation [%]

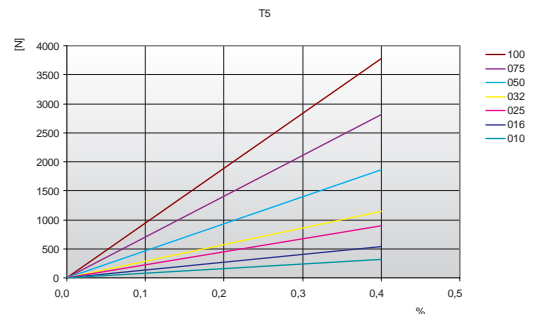

Tooth shear strength

rpm	F_{Uspez} [N/cm]	rpm	F_{Uspez} [N/cm]	rpm	F_{Uspez} [N/cm]	rpm	F_{Uspez} [N/cm]
0	24,70	800	17,02	1900	14,21	4500	11,25
20	24,07	900	16,65	2000	14,03	5000	10,88
40	23,53	1000	16,32	2200	13,71	5500	10,55
60	23,05	1100	16,01	2400	13,42	6000	10,24
80	22,64	1200	15,73	2600	13,14	6500	9,96
100	22,28	1300	15,47	2800	12,89	7000	9,70
200	20,90	1400	15,22	3000	12,65	7500	9,46
300	19,89	1440	15,13	3200	12,43	8000	9,23
400	19,10	1500	15,00	3400	12,22	8500	9,01
500	18,45	1600	14,78	3600	12,03	9000	8,81
600	17,91	1700	14,58	3800	11,84	9500	8,62
700	17,44	1800	14,39	4000	11,66	10000	8,44

Tooth shear strength / rpm

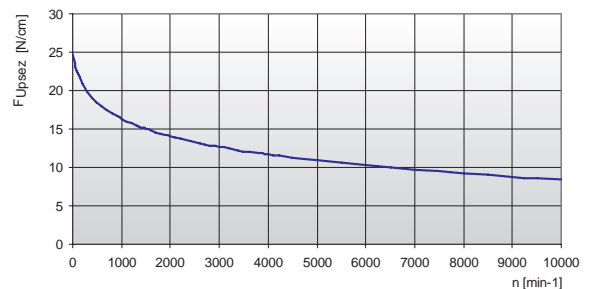

The specific load F_{Uspez} is the maximum load which one single belt tooth 1 cm wide can withstand in all operating conditions. This force is related to the drive rpm.

The total load F_u transmissible by the belt in the drive is calculated by:



$$F_u [N] = F_{Uspez} \cdot Z_e \cdot b$$

- $F_u [N]$ = peripheral force
- $F_{Uspez} [N/cm]$ = specific load
- Z_e = number of teeth in mesh in the small pulley
- Z_{emax} = max. no of teeth in mesh to be considered for the calculation of the drive
- Z_{emax} = 12 for ELATECH® M
- Z_{emax} = 6 for ELATECH® V
- $b [cm]$ = belt width in cm

Specialties

Belt width b [mm]	ARAMID CORD		HPL High Performance	
	F _{Tzul} [N] M type	F _{Br} [N]	F _{Tzul} [N] M type	F _{Br} [N]
10	700	2800	920	3360
16	1190	4760	1610	5880
25	1960	7840	2645	9660
32	2520	10080	3450	12600
50	4060	16240	5520	20160
75	6160	24640	8395	30660
100	8260	33040	11270	41160
150	-	-	16905	61740

Flexibility

Minimum pulley number of teeth and minimum idler diameter		Type of cord		
		STANDARD	ARAMID	HPL
Drive without reverse bending 	Timing pulley z _{min}	10	10	24
	Flat idler running on belt teeth d _{min}	30 mm	30 mm	60 mm
Drive with reverse bending 	Timing pulley z _{min}	15	15	38
	Flat idler running on belt back d _{min}	30 mm	30 mm	60 mm

Timing pulleys

z	da	dw	z	da	dw	z	da	dw	z	da	dw
10	15,05	15,92	40	62,85	63,66	70	110,60	111,44	100	158,35	159,20
11	16,65	17,51	41	64,4	65,27	71	112,20	113,03	101	159,95	160,79
12	18,25	19,10	42	66	66,86	72	113,75	114,62	102	161,55	162,38
13	19,85	20,70	43	67,7	68,46	73	115,35	116,22	103	163,10	163,97
14	21,45	22,29	44	69,2	70,05	74	116,95	117,81	104	164,70	165,57
15	23,05	23,88	45	70,8	71,64	75	118,55	119,40	105	166,30	167,16
16	24,60	25,47	46	72,4	73,23	76	120,15	120,99	106	167,90	168,75
17	26,20	27,06	47	73,95	74,82	77	121,75	122,58	107	169,50	170,34
18	27,80	28,65	48	75,55	76,42	78	123,30	124,18	108	171,10	171,94
19	29,40	30,25	49	77,15	78,01	79	124,90	125,77	109	172,65	173,53
20	31,00	31,83	50	78,75	79,60	80	126,50	127,36	110	174,25	175,12
21	32,70	33,43	51	80,35	81,19	81	128,10	128,95	111	175,85	176,71
22	34,25	35,02	52	81,95	82,78	82	129,70	130,54	112	177,45	178,30
23	35,85	36,62	53	83,5	84,38	83	131,30	132,14	113	179,05	179,84
24	37,40	38,21	54	85,1	85,97	84	132,85	133,73	114	180,65	181,49
25	39,00	39,80	55	86,7	87,54	85	134,45	135,32	115	182,23	183,08
26	40,60	41,39	56	88,3	89,15	86	136,05	136,91	116	183,82	184,67
27	42,20	42,98	57	89,9	90,74	87	137,65	138,50	117	185,42	186,26
28	43,75	44,58	58	91,5	92,34	88	139,25	140,10	118	187,01	187,86
29	45,35	46,17	59	93,05	93,93	89	140,85	141,69	119	188,61	189,45
30	46,95	47,76	60	94,65	95,52	90	142,45	143,28	120	190,21	191,04
31	48,55	49,35	61	96,25	97,11	91	144,00	144,87			
32	50,10	50,94	62	97,85	98,70	92	145,60	146,46			
33	51,70	52,54	63	99,45	100,30	93	147,20	148,06			
34	53,25	54,13	64	101,05	101,89	94	148,80	149,65			
35	54,85	55,72	65	102,65	103,48	95	150,40	151,24			
36	56,45	57,31	66	104,2	105,07	96	152,00	152,83			
37	58,05	58,90	67	105,8	106,66	97	153,55	154,42			
38	59,65	60,50	68	107,40	108,26	98	155,15	156,02			
39	61,25	62,09	69	109,00	109,85	99	156,75	157,61			

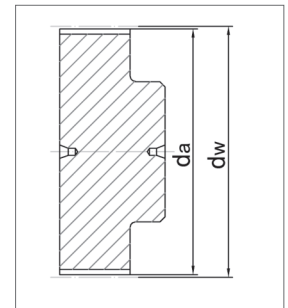

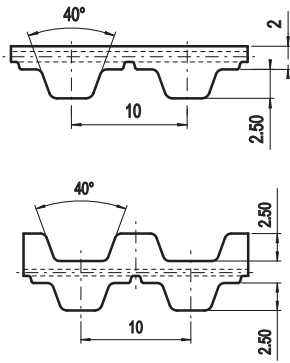

Belt characteristics

- Polyurethane timing belt with steel tension cords
- Trapezoidal tooth profile according to DIN 7721 T1
- Metric pitch 10 mm
- Ideal for drives where high belt flexibility is requested
- Widely used for conveying, linear drive and medium power transmission applications
- Double sided tooth construction available

- Width tolerance: $\pm 0,5$ [mm]
- Length tolerance: $\pm 0,5$ [mm/m]
- Thickness tolerance: $\pm 0,2$ [mm]

Technical Data

Belt width b [mm]	Allowable tensile load Type M F_{Tzul} [N]	Allowable tensile load Type V F_{Tzul} [N]	Breaking load Type M F_{Br} [N]	Specific spring rate C_{spez} [N]	Weight [kg/m]
10	920	460	3360	230000	0,05
16	1610	805	5880	402500	0,07
25	2650	1325	9660	662500	0,11
32	3450	1725	12600	862500	0,15
50	5520	2760	20160	1380000	0,23
75	8400	4200	30660	2100000	0,34
100	11270	5635	41160	2817500	0,45
150	17020	8510	62160	4255000	0,68
200	11270	5635	41160	2817500	0,60

Other widths are available on request.

Tooth shear strength

rpm	F_{Uspez} [N/cm]	rpm	F_{Uspez} [N/cm]	rpm	F_{Uspez} [N/cm]	rpm	F_{Uspez} [N/cm]
0	51,80	800	33,34	1900	26,53	4500	19,40
20	50,32	900	32,44	2000	26,12	5000	18,51
40	49,04	1000	31,63	2200	25,34	5500	17,70
60	47,92	1100	30,89	2400	24,63	6000	16,97
80	46,95	1200	30,21	2600	23,97	6500	16,29
100	46,11	1300	29,58	2800	23,36	7000	15,66
200	42,75	1400	28,99	3000	22,78	7500	15,07
300	40,28	1440	28,76	3200	22,25	8000	14,52
400	38,36	1500	28,44	3400	21,74	8500	14,00
500	36,80	1600	27,92	3600	21,27	9000	13,51
600	35,49	1700	27,43	3800	20,81	9500	13,05
700	34,35	1800	26,97	4000	20,39	10000	12,61

The specific load F_{Uspez} is the maximum load which one single belt tooth 1 cm wide can withstand in all operating conditions. This force is related to the drive rpm. The total load F_u transmissible by the belt in the drive is calculated by:

$$F_u [N] = F_{Uspez} \cdot Z_e \cdot b$$

- F_u [N] = peripheral force
- F_{Uspez} [N/cm] = specific load
- Z_e = number of teeth in mesh in the small pulley
- Z_{emax} = max. no of teeth in mesh to be considered for the calculation of the drive
- Z_{emax} = 12 for ELATECH® M
- Z_{emax} = 6 for ELATECH® V
- b [cm] = belt width in cm

Load / Elongation [%]

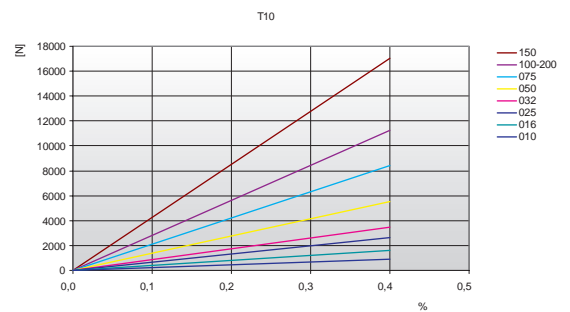

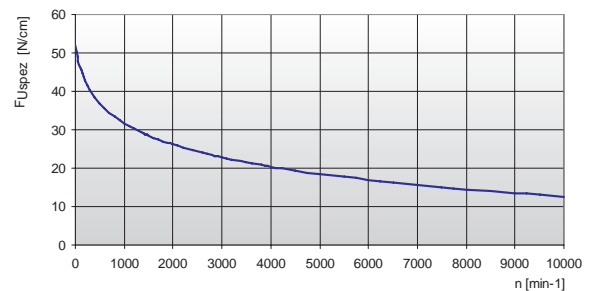

Tooth shear strength / rpm



Specialties

Belt width b [mm]	ARAMID CORD		STAINLESS STEEL		HPL High Performance		HFE High Flexibility	
	F_{Tzul} [N] M type	F_{Br} [N]	F_{Tzul} [N] M type	F_{Br} [N]	F_{Tzul} [N] M type	F_{Br} [N]	F_{Tzul} [N] M type	F_{Br} [N]
10	880	3600	600	2400	-	-	960	3440
16	1540	6300	1050	4200	2450	9500	1680	6020
25	2530	10350	1730	6900	4165	16150	2760	9890
32	3300	13500	2250	9000	5390	20900	3600	12900
50	5280	21600	3600	14400	8575	33250	5760	20640
75	8030	32850	-	-	12990	50350	-	-
100	10780	44100	-	-	17400	67450	-	-
150	16280	66600	-	-	-	-	-	-
200	10780	44100	-	-	-	-	-	-

Flexibility

Minimum pulley number of teeth and minimum idler diameter		Type of cord				
		STANDARD	ARAMID	STAINLESS	HPL	HFE
Drive without reverse bending 	Timing pulley z_{min}	12	15	15	15	10
	Flat idler running on belt teeth d_{min}	60 mm	60 mm	60 mm	100 mm	50 mm
Drive with reverse bending 	Timing pulley z_{min}	20	20	40	30	15
	Flat idler running on belt back d_{min}	60 mm	60 mm	120 mm	100 mm	50 mm

Timing pulleys

z	da	dw	z	da	dw	z	da	dw	z	da	dw
10	30,05	31,84	40	125,45	127,32	71	224,15	225,99	101	319,65	321,48
11	33,25	35,02	41	128,65	130,50	72	227,30	229,18	102	322,80	324,66
12	36,35	38,20	42	131,85	133,69	73	230,50	232,36	103	326,00	327,85
13	39,50	41,38	44	138,20	140,05	74	233,70	235,54	104	329,20	331,03
14	42,70	44,56	45	141,40	143,24	75	236,90	238,72	105	332,35	334,21
15	45,90	47,75	46	144,60	146,42	76	240,05	241,94	106	335,55	337,40
16	49,05	50,93	47	147,75	149,60	77	243,25	245,09	107	338,75	340,58
17	52,25	54,11	48	150,95	152,78	78	246,40	248,27	108	341,95	343,76
18	55,45	57,29	49	154,10	155,97	79	249,60	251,46	109	345,15	346,95
19	58,65	60,48	50	157,30	159,15	80	252,80	254,64	110	348,30	350,13
20	61,80	63,66	51	160,50	162,33	81	256,00	257,82	111	351,45	353,31
21	65,00	66,84	52	163,65	165,52	82	259,15	261,00	112	354,65	356,50
22	68,15	70,03	53	166,85	168,70	83	262,30	264,19	113	357,80	359,68
23	71,35	73,20	54	170,05	171,88	84	265,50	267,37	114	361,00	362,86
24	74,55	76,39	55	173,20	175,06	85	268,70	270,55	115	364,19	366,04
25	77,70	79,58	56	176,40	178,25	86	271,90	273,74	116	367,39	369,23
26	80,90	82,76	57	179,60	181,43	87	275,05	276,92	117	370,56	372,41
27	84,10	85,95	58	182,75	184,61	88	278,25	280,10	118	373,76	375,59
28	87,25	89,12	59	185,95	187,80	89	281,45	283,28	119	376,93	378,78
29	90,45	92,21	60	189,10	190,98	90	284,60	286,47	120	380,11	381,96
30	93,65	95,49	61	192,30	194,16	91	287,80	289,65			
31	96,85	98,67	62	195,50	197,35	92	291,00	292,84			
32	100,00	101,86	63	198,65	200,53	93	294,20	296,02			
33	103,20	105,04	64	201,85	203,71	94	297,35	299,20			
34	106,40	108,22	65	205,05	206,90	95	300,55	302,39			
35	109,55	111,41	66	208,20	210,08	96	303,75	305,57			
36	112,75	114,59	67	211,40	213,26	97	306,90	308,75			
37	115,90	117,77	68	214,60	216,44	98	310,10	311,93			
38	119,10	120,95	69	217,75	219,63	99	313,25	315,12			
39	122,30	124,14	70	220,95	222,81	100	316,45	318,30			

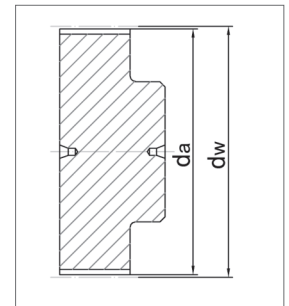

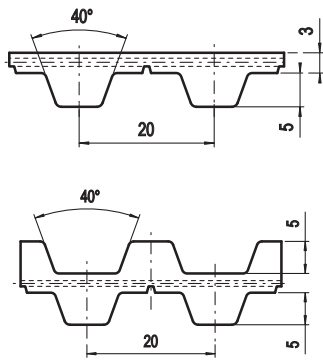

Belt characteristics

- Polyurethane timing belt with steel tension cords
- Trapezoidal tooth profile according to DIN 7721 T1
- Metric pitch 20 mm
- Ideal for drives where high belt flexibility is requested
- Widely used for conveying, linear drive and heavy power transmission applications
- Double sided tooth construction available

- Width tolerance: $\pm 1,0$ [mm]
- Length tolerance: $\pm 0,5$ [mm/m]
- Thickness tolerance: $\pm 0,4$ [mm]

Technical Data

Belt width b [mm]	Allowable tensile load Type M F_{Tzul} [N]	Allowable tensile load Type V F_{Tzul} [N]	Breaking load Type M F_{Br} [N]	Specific spring rate C_{spez} [N]	Weight [kg/m]
25	4170	2085	16150	1042500	0,20
32	5390	2695	20900	1347500	0,26
50	8580	4290	33250	2145000	0,41
75	12990	6495	50350	3247500	0,61
100	17400	8700	67450	4350000	0,82
150	26220	13110	101650	6555000	1,23

Load / Elongation [%]

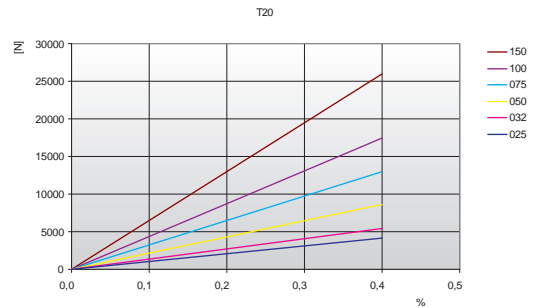

Other widths are available on request.

Tooth shear strength

rpm	F_{Uspez} [N/cm]	rpm	F_{Uspez} [N/cm]	rpm	F_{Uspez} [N/cm]	rpm	F_{Uspez} [N/cm]
0	104,50	800	62,15	1900	46,88	4500	30,92
20	101,10	900	60,13	2000	45,94	5000	28,93
40	98,15	1000	58,31	2200	44,20	5500	27,14
60	95,58	1100	56,64	2400	42,61	6000	25,49
80	93,35	1200	55,11	2600	41,13	6500	23,97
100	91,41	1300	53,70	2800	39,77	-	-
200	83,50	1400	52,38	3000	38,49	-	-
300	77,84	1440	51,87	3200	37,29	-	-
400	73,49	1500	51,14	3400	36,16	-	-
500	69,96	1600	49,98	3600	35,10	-	-
600	66,98	1700	48,89	3800	34,09	-	-
700	64,41	1800	47,86	4000	33,13	-	-

Tooth shear strength / rpm

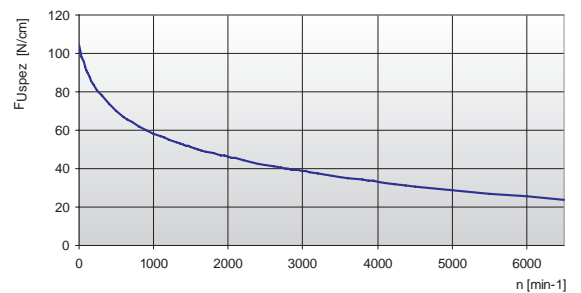

The specific load F_{Uspez} is the maximum load which one single belt tooth 1 cm wide can withstand in all operating conditions. This force is related to the drive rpm.

The total load F_U transmissible by the belt in the drive is calculated by:



$$F_U [N] = F_{Uspez} \cdot Z_e \cdot b$$

- $F_U [N]$ = peripheral force
- $F_{Uspez} [N/cm]$ = specific load
- Z_e = number of teeth in mesh in the small pulley
- Z_{emax} = max. no of teeth in mesh to be considered for the calculation of the drive
- Z_{emax} = 12 for ELATECH® M
- Z_{emax} = 6 for ELATECH® V
- $b [cm]$ = belt width in cm

Specialties

Belt width b [mm]	ARAMID CORD		STAINLESS STEEL		HFE High Flexibility	
	F _{Tzul} [N] M type	F _{Br} [N]	F _{Tzul} [N] M type	F _{Br} [N]	F _{Tzul} [N] M type	F _{Br} [N]
25	3740	17000	3060	12750	3400	14450
32	4840	22000	3960	16500	4400	18700
50	7700	35000	6300	26250	7000	29750
75	11660	53000	-	-	-	-
100	15620	71000	-	-	-	-
150	24300	110000	-	-	-	-

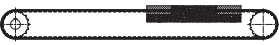
Flexibility

Minimum pulley number of teeth and minimum idler diameter		Type of cord			
		STANDARD	ARAMID	STAINLESS	HFE
Drive without reverse bending 	Timing pulley z _{min}	15	15	20	12
	Flat idler running on belt teeth d _{min}	120 mm	120 mm	130 mm	100 mm
Drive with reverse bending 	Timing pulley z _{min}	25	25	30	22
	Flat idler running on belt back d _{min}	120 mm	120 mm	150 mm	120 mm

Timing pulleys

z	da	dw	z	da	dw	z	da	dw	z	da	dw
15	92,65	95,49	45	283,60	286,47	75	474,60	477,45	105	665,60	668,43
16	99,00	101,86	46	289,95	292,84	76	480,95	483,82	106	671,95	674,80
17	105,40	108,22	47	296,35	299,21	77	487,35	490,19	107	678,30	681,17
18	111,75	114,59	48	302,70	305,58	78	493,70	496,56	108	684,70	687,54
19	118,10	120,96	49	309,10	311,93	79	500,05	502,91	109	691,05	693,89
20	124,50	127,32	50	315,45	318,30	80	506,45	509,28	110	697,40	700,26
21	130,75	133,69	51	321,80	324,67	81	512,80	515,65	111	703,80	706,63
22	137,20	140,06	52	328,15	331,03	82	519,15	522,02	112	710,15	712,99
23	143,55	146,43	53	334,50	337,40	83	525,55	528,39	113	716,50	719,36
24	149,95	152,78	54	340,90	343,76	84	531,90	534,74	114	722,90	725,73
25	156,30	159,15	55	347,25	350,13	85	538,25	541,11	115	729,24	732,09
26	162,65	165,52	56	353,60	356,50	86	544,60	547,48	116	735,61	738,46
27	169,00	171,89	57	360,00	362,86	87	551,00	553,85	117	741,96	744,83
28	175,40	178,25	58	366,35	369,23	88	557,35	560,22	118	748,34	751,19
29	181,75	184,62	59	372,75	375,59	89	563,70	566,57	119	754,70	757,56
30	188,10	190,99	60	379,10	381,96	90	570,10	572,94	120	761,07	763,93
31	194,50	197,35	61	385,45	388,33	91	576,45	579,31			
32	200,85	203,72	62	391,85	394,70	92	582,85	585,67			
33	207,20	210,09	63	398,20	401,06	93	589,20	592,04			
34	213,60	216,44	64	404,55	407,43	94	595,55	598,41			
35	219,95	222,81	65	410,95	413,80	95	601,90	604,77			
36	226,35	229,18	66	417,30	420,17	96	608,30	611,14			
37	232,70	235,54	67	423,65	426,52	97	614,65	617,51			
38	239,05	241,91	68	430,05	432,89	98	621,00	623,88			
39	245,40	248,28	69	436,40	439,26	99	627,35	630,25			
40	251,75	254,65	70	442,80	445,63	100	633,75	636,60			
41	258,15	261,02	71	449,15	451,99	101	640,10	642,97			
42	264,50	267,37	72	455,50	458,36	102	646,50	649,34			
43	270,85	273,74	73	461,85	464,73	103	652,85	655,71			
44	277,25	280,10	74	468,25	471,08	104	659,20	662,06			

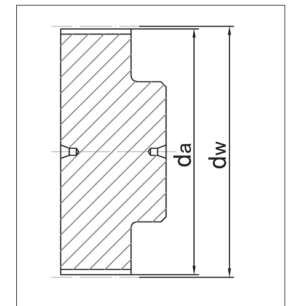

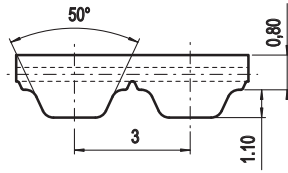

Belt characteristics

- Polyurethane timing belt with steel tension cords
- Metric pitch 3 mm
- Tooth profile and dimension are optimised to guarantee uniform load distribution and minimum deformation under load
- High resistance and low stretch steel cords to guarantee high stability and low elongation
- Reduced polygonal effect with reduced drive vibration
- Particularly suitable for linear drives and light power transmission applications with high axial and angular positioning accuracy.
- Negative length tolerance available on request

- Width tolerance: $\pm 0,5$ [mm]
- Length tolerance: $\pm 0,5$ [mm/m]
- Thickness tolerance: $\pm 0,2$ [mm]

Technical Data

Belt width b [mm]	Allowable tensile load Type M F_{Tzul} [N]	Allowable tensile load Type V F_{Tzul} [N]	Breaking load Type M F_{Br} [N]	Specific spring rate C_{spez} [N]	Weight [kg/m]
8	260	130	1000	65000	0,18
10	320	160	1250	80000	0,22
12	416	208	1625	104000	0,26
16	540	270	2125	135000	0,35
20	700	350	2750	175000	0,44
25	900	450	3500	225000	0,54

Load / Elongation [%]

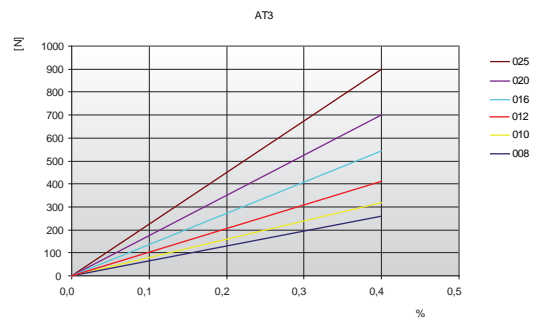

Other widths are available on request.

Tooth shear strength

rpm	F_{Uspez} [N/cm]	rpm	F_{Uspez} [N/cm]	rpm	F_{Uspez} [N/cm]	rpm	F_{Uspez} [N/cm]
0	32,50	800	25,62	1900	20,98	4500	15,64
20	32,13	900	25,05	2000	20,68	5000	14,96
40	31,79	1000	24,52	2200	20,11	5500	14,33
60	31,48	1100	24,02	2400	19,59	6000	13,76
80	31,19	1200	23,56	2600	19,10	6500	13,23
100	30,92	1300	23,13	2800	18,64	7000	12,74
200	29,86	1400	22,72	3000	18,22	7500	12,28
300	29,15	1440	22,57	3200	17,81	8000	11,84
400	28,47	1500	22,34	3400	17,43	8500	11,43
500	27,66	1600	21,97	3600	17,07	9000	11,05
600	26,92	1700	21,63	3800	16,73	9500	10,68
700	26,25	1800	21,29	4000	16,40	10000	10,34

Tooth shear strength / rpm

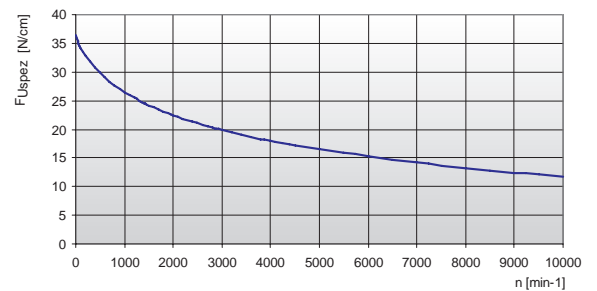

The specific load F_{Uspez} is the maximum load which one single belt tooth 1 cm wide can withstand in all operating conditions. This force is related to the drive rpm. The total load F_U transmissible by the belt in the drive is calculated by:

$$F_U [N] = F_{Uspez} \cdot Z_e \cdot b$$

- $F_U [N]$ = peripheral force
- $F_{Uspez} [N/cm]$ = specific load
- Z_e = number of teeth in mesh in the small pulley
- Z_{emax} = max. no of teeth in mesh to be considered for the calculation of the drive
- Z_{emax} = 12 for ELATECH® M
- Z_{emax} = 6 for ELATECH® V
- $b [cm]$ = belt width in cm

Flexibility

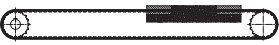
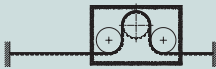
Minimum pulley number of teeth and minimum idler diameter		Type of cord
		STANDARD
Drive without reverse bending 	Timing pulley z_{min}	15
	Flat idler running on belt teeth d_{min}	20 mm
Drive with reverse bending 	Timing pulley z_{min}	20
	Flat idler running on belt back d_{min}	20 mm

Timing pulleys

z	da	dw	z	da	dw
15	13,92	14,32	45	42,56	42,97
16	14,87	15,28	46	43,52	43,93
17	15,82	16,23	47	44,47	44,88
18	16,78	17,19	48	45,43	45,84
19	17,73	18,14	49	46,38	46,79
20	18,69	19,10	50	47,34	47,75
21	19,64	20,05	51	48,29	48,70
22	20,60	21,01	52	49,25	49,66
23	21,55	21,96	53	50,20	50,61
24	22,51	22,92	54	51,16	51,57
25	23,46	23,87	55	52,11	52,52
26	24,42	24,83	56	53,07	53,48
27	25,37	25,78	57	54,02	54,43
28	26,33	26,74	58	54,98	55,39
29	27,28	27,69	59	55,93	56,34
30	28,24	28,65	60	56,89	57,30
31	29,19	29,60	61	57,84	58,25
32	30,15	30,56	62	58,80	59,21
33	31,10	31,51	63	59,75	60,16
34	32,06	32,47	64	60,71	61,12
35	33,01	33,42	65	61,66	62,07
36	33,97	34,38	66	62,62	63,03
37	34,92	35,33	67	63,57	63,98
38	35,88	36,29	68	64,53	64,94
39	36,83	37,24	69	65,48	65,89
40	37,79	38,20	70	66,44	66,85
41	38,74	39,15	71	67,39	67,80
42	39,70	40,11	72	68,35	68,75
43	40,65	41,06			
44	41,61	42,02			

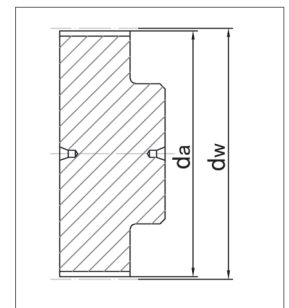

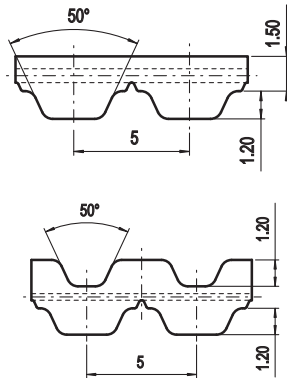

Belt characteristics

- Polyurethane timing belt with steel tension cords
- Metric pitch 5 mm
- Tooth profile and dimension are optimised to guarantee uniform load distribution and minimum deformation under load
- High resistance and low stretch steel cords to guarantee high stability and low elongation
- Reduced polygonal effect with reduced drive vibration
- Particularly suitable for linear drives and light power transmission applications with high axial and angular positioning accuracy
- Double sided tooth construction available
- Negative length tolerance available on request

- Width tolerance: $\pm 0,5$ [mm]
- Length tolerance: $\pm 0,5$ [mm/m]
- Thickness tolerance: $\pm 0,2$ [mm]

Technical Data

Belt width b [mm]	Allowable tensile load Type M F_{Tzul} [N]	Allowable tensile load Type V F_{Tzul} [N]	Breaking load Type M F_{Br} [N]	Specific spring rate C_{spez} [N]	Weight [kg/m]
10	640	320	2160	160000	0,03
16	1120	560	3780	280000	0,05
25	1840	920	6210	460000	0,09
32	2400	1200	8100	600000	0,11
50	3840	1920	12960	960000	0,17
75	5840	2920	19710	1460000	0,26
100	7840	3920	26460	1960000	0,34

Other widths are available on request.

Load / Elongation [%]

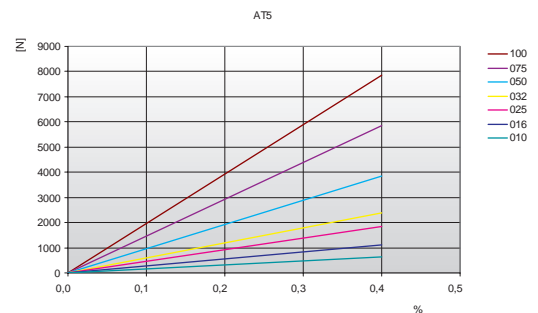

Tooth shear strength

rpm	F_{Uspez} [N/cm]	rpm	F_{Uspez} [N/cm]	rpm	F_{Uspez} [N/cm]	rpm	F_{Uspez} [N/cm]
0	36,40	800	27,69	1900	22,73	4500	17,18
20	35,88	900	27,06	2000	22,42	5000	16,47
40	35,40	1000	26,49	2200	21,82	5500	15,83
60	34,97	1100	25,96	2400	21,28	6000	15,24
80	34,59	1200	25,47	2600	20,77	6500	14,69
100	34,24	1300	25,01	2800	20,29	7000	14,18
200	32,92	1400	24,57	3000	19,85	7500	13,71
300	31,92	1440	24,41	3200	19,43	8000	13,26
400	30,89	1500	24,16	3400	19,03	8500	12,85
500	29,95	1600	23,78	3600	18,66	9000	12,45
600	29,12	1700	23,41	3800	18,30	9500	12,07
700	28,37	1800	23,07	4000	17,96	10000	11,72

Tooth shear strength / rpm

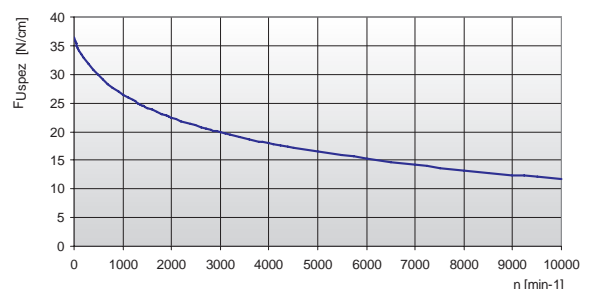

The specific load F_{Uspez} is the maximum load which one single belt tooth 1 cm wide can withstand in all operating conditions. This force is related to the drive rpm. The total load F_u transmissible by the belt in the drive is calculated by:



$$F_u [N] = F_{Uspez} \cdot z_e \cdot b$$

- F_u [N] = peripheral force
- F_{Uspez} [N/cm] = specific load
- z_e = number of teeth in mesh in the small pulley
- z_{emax} = max. no. of teeth in mesh to be considered for the calculation of the drive
- z_{emax} = 12 for ELATECH® M
- z_{emax} = 6 for ELATECH® V
- b [cm] = belt width in cm

Specialties

Belt width b [mm]	ARAMID CORD		STAINLESS STEEL		HFE High Flexibility	
	F_{Tzul} [N] M type	F_{Br} [N]	F_{Tzul} [N] M type	F_{Br} [N]	F_{Tzul} [N] M type	F_{Br} [N]
10	880	3600	600	2400	960	3440
16	1540	6300	1050	4200	1680	6020
25	2530	10350	1730	6900	2760	9890
32	3300	13500	2250	9000	3600	12900
50	5280	21600	3600	14400	5760	20640
75	8030	32850	-	-	-	-
100	10780	44100	-	-	-	-

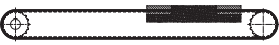
Flexibility

Minimum pulley number of teeth and minimum idler diameter		Type of cord			
		STANDARD	ARAMID	STAINLESS	HFE
Drive without reverse bending 	Timing pulley z_{min}	15	15	18	15
	Flat idler running on belt teeth d_{min}	30 mm	30 mm	40 mm	25 mm
Drive with reverse bending 	Timing pulley z_{min}	25	25	25	20
	Flat idler running on belt back d_{min}	60 mm	60 mm	65 mm	50 mm

Timing pulleys

z	da	dw	z	da	dw	z	da	dw	z	da	dw
15	22,65	23,88	45	70,40	71,64	75	118,15	119,40	105	165,90	167,16
16	24,20	25,47	46	72,00	73,23	76	119,75	120,99	106	167,50	168,75
17	25,80	27,06	47	73,55	74,82	77	121,35	122,58	107	169,10	170,34
18	27,40	28,65	48	75,15	76,42	78	122,90	124,18	108	170,70	171,94
19	29,00	30,25	49	76,75	78,01	79	124,50	125,77	109	172,25	173,53
20	30,60	31,83	50	78,35	79,60	80	126,10	127,36	110	173,85	175,12
21	32,20	33,43	51	79,95	81,19	81	127,70	128,95	111	175,45	176,71
22	33,80	35,02	52	81,55	82,78	82	129,30	130,54	112	177,05	178,30
23	35,40	36,62	53	83,10	84,38	83	130,90	132,14	113	178,65	179,84
24	37,00	38,21	54	84,70	85,97	84	132,45	133,73	114	180,25	181,49
25	38,60	39,80	55	86,30	87,54	85	134,05	135,32	115	181,85	183,08
26	40,20	41,39	56	87,90	89,15	86	135,65	136,91	116	183,45	184,67
27	41,80	42,98	57	89,50	90,74	87	137,25	138,50	117	185,00	186,26
28	43,35	44,58	58	91,10	92,34	88	138,85	140,10	118	186,60	187,86
29	44,95	46,17	59	92,65	93,93	89	140,45	141,69	119	188,20	189,45
30	46,55	47,76	60	94,25	95,52	90	142,05	143,28	120	189,80	191,04
31	48,15	49,35	61	95,85	97,11	91	143,60	144,87			
32	49,70	50,94	62	97,45	98,70	92	145,20	146,46			
33	51,30	52,54	63	99,05	100,30	93	146,80	148,06			
34	52,85	54,13	64	100,65	101,89	94	148,40	149,65			
35	54,45	55,72	65	102,25	103,48	95	150,00	151,24			
36	56,05	57,31	66	103,80	105,07	96	151,60	152,83			
37	57,65	58,90	67	105,40	106,66	97	153,15	154,42			
38	59,25	60,50	68	107,00	108,26	98	154,75	156,02			
39	60,85	62,09	69	108,60	109,85	99	156,35	157,61			
40	62,45	63,66	70	110,20	111,44	100	157,95	159,20			
41	64,00	65,27	71	111,80	113,03	101	159,55	160,79			
42	65,60	66,86	72	113,35	114,62	102	161,15	162,38			
43	67,30	68,46	73	114,95	116,22	103	162,70	163,97			
44	68,80	70,05	74	116,55	117,81	104	164,30	165,57			

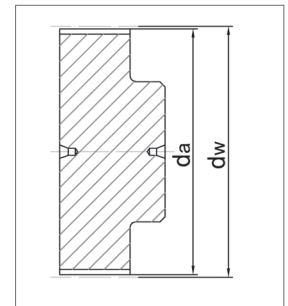

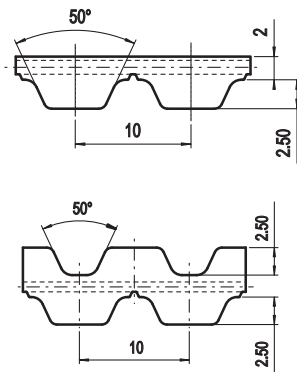

Belt characteristics

- Polyurethane timing belt with steel tension cords.
- Metric pitch 10 mm
- Tooth profile and dimension are optimised to guarantee uniform load distribution and minimum deformation under load
- High resistance and low stretch steel cords to guarantee high stability and low elongation
- Reduced polygonal effect with reduced drive vibration
- Particularly suitable for linear drives and medium power transmission applications with high axial and angular positioning accuracy
- Double sided tooth construction available
- Negative length tolerance available on request

- Width tolerance: $\pm 0,5$ [mm]
- Length tolerance: $\pm 0,5$ [mm/m]
- Thickness tolerance: $\pm 0,2$ [mm]

Technical Data

Belt width b [mm]	Allowable tensile load Type M F_{Tzul} [N]	Allowable tensile load Type V F_{Tzul} [N]	Breaking load Type M F_{Br} [N]	Specific spring rate C_{spez} [N]	Weight [kg/m]
16	2450	1225	9500	612500	0,09
25	4170	2085	16150	1042500	0,15
32	5390	2695	20900	1347500	0,19
50	8580	4290	33250	2145000	0,30
75	12990	6495	50350	3247500	0,44
100	17400	8700	67450	4350000	0,59
150	26220	13110	101650	6555000	0,90

Other widths are available on request.

Load / Elongation [%]

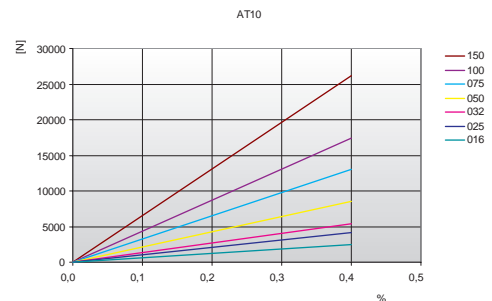

Tooth shear strength

rpm	F_{Uspez} [N/cm]	rpm	F_{Uspez} [N/cm]	rpm	F_{Uspez} [N/cm]	rpm	F_{Uspez} [N/cm]
0	88,57	800	62,83	1900	49,16	4500	34,08
20	87,06	900	61,09	2000	48,29	5000	32,17
40	85,66	1000	59,49	2200	46,67	5500	30,43
60	84,35	1100	58,02	2400	45,18	6000	28,84
80	83,13	1200	56,66	2600	43,80	6500	27,37
100	81,99	1300	55,39	2800	42,51	7000	26,01
200	77,36	1400	54,20	3000	41,30	7500	24,73
300	75,09	1440	53,74	3200	40,17	8000	23,53
400	71,99	1500	53,08	3400	39,09	8500	22,41
500	69,27	1600	52,02	3600	38,08	9000	21,34
600	66,88	1700	51,02	3800	37,11	9500	20,33
700	64,75	1800	50,06	4000	36,20	10000	19,37

Tooth shear strength / rpm

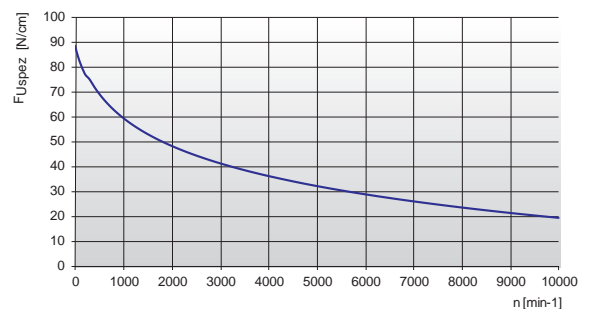

The specific load F_{Uspez} is the maximum load which one single belt tooth 1 cm wide can withstand in all operating conditions. This force is related to the drive rpm. The total load F_u transmissible by the belt in the drive is calculated by:



$$F_u [N] = F_{Uspez} \cdot Z_e \cdot b$$

- F_u [N] = peripheral force
- F_{Uspez} [N/cm] = specific load
- Z_e = number of teeth in mesh in the small pulley
- Z_{emax} = max. no of teeth in mesh to be considered for the calculation of the drive
- Z_{emax} = 12 for ELATECH® M
- Z_{emax} = 6 for ELATECH® V
- b [cm] = belt width in cm

Specialties

Belt width b [mm]	ARAMID CORD		STAINLESS STEEL		HFE High Flexibility	
	F_{Tzul} [N] M type	F_{Br} [N]	F_{Tzul} [N] M type	F_{Br} [N]	F_{Tzul} [N] M type	F_{Br} [N]
16	2200	7900	1800	7500	2000	8500
25	3740	13430	3060	12750	3400	14450
32	4840	17380	3960	16500	4400	18700
50	7700	27650	6300	26250	7000	29750
75	11660	41870	-	-	-	-
100	15620	56090	-	-	-	-
150	23540	84530	-	-	-	-

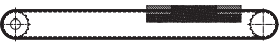
Flexibility

Minimum pulley number of teeth and minimum idler diameter		Type of cord			
		STANDARD	ARAMID	STAINLESS	HFE
Drive without reverse bending 	Timing pulley z_{min}	15	15	20	12
	Flat idler running on belt teeth d_{min}	50 mm	50 mm	70 mm	50 mm
Drive with reverse bending 	Timing pulley z_{min}	25	20	40	20
	Flat idler running on belt back d_{min}	120 mm	120 mm	120 mm	80 mm

Timing pulleys

z	da	dw	z	da	dw	z	da	dw	z	da	dw
15	45,70	47,75	45	141,40	143,24	75	236,90	238,72	105	332,35	334,21
16	49,05	50,93	46	144,55	146,42	76	240,05	241,94	106	335,55	337,40
17	52,25	54,11	47	147,75	149,60	77	243,25	245,09	107	338,75	340,58
18	55,45	57,29	48	150,95	152,78	78	246,40	248,24	108	341,90	343,76
19	58,60	60,48	49	154,10	155,97	79	249,60	251,46	109	345,10	346,95
20	61,80	63,66	50	157,30	159,15	80	252,80	254,64	110	348,30	350,13
21	65,00	66,84	51	160,50	162,33	81	255,95	257,82	111	351,45	353,31
22	68,15	70,03	52	163,65	165,52	82	259,15	261,00	112	354,65	356,50
23	71,35	73,20	53	166,85	168,70	83	262,30	264,19	113	357,80	359,68
24	74,55	76,39	54	170,05	171,88	84	265,50	267,37	114	361,00	362,86
25	77,70	79,58	55	173,20	175,06	85	268,70	270,52	115	364,19	366,04
26	80,90	82,76	56	176,40	178,25	86	271,90	273,74	116	367,39	369,23
27	84,10	85,95	57	179,60	181,43	87	275,05	276,92	117	370,56	372,41
28	87,25	89,12	58	182,75	184,61	88	278,25	280,10	118	373,74	375,59
29	90,45	92,21	59	185,95	187,80	89	281,45	283,28	119	376,93	378,78
30	93,65	95,49	60	189,10	190,98	90	284,60	286,47	120	380,11	381,96
31	96,80	98,67	61	192,30	194,16	91	287,80	289,65			
32	100,00	101,86	62	195,50	197,35	92	291,00	292,84			
33	103,20	105,04	63	198,65	200,53	93	294,20	296,02			
34	106,40	108,19	64	201,85	203,71	94	297,35	299,20			
35	109,55	111,41	65	205,05	206,90	95	300,55	302,39			
36	112,75	114,59	66	208,20	210,08	96	303,70	305,57			
37	115,90	117,77	67	211,40	213,26	97	306,90	308,75			
38	119,10	120,95	68	214,60	216,44	98	310,10	311,93			
39	122,30	124,14	69	217,75	219,63	99	313,25	315,12			
40	125,45	127,32	70	220,95	222,81	100	316,45	318,30			
41	128,65	130,50	71	224,15	225,99	101	319,65	321,48			
42	131,85	133,69	72	227,30	229,18	102	322,80	324,66			
43	135,00	136,87	73	230,50	232,33	103	326,00	327,85			
44	138,20	140,05	74	233,70	235,54	104	329,20	331,03			

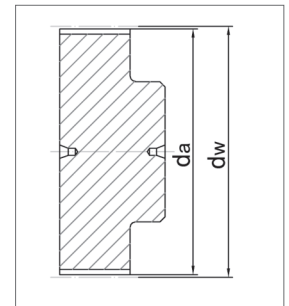

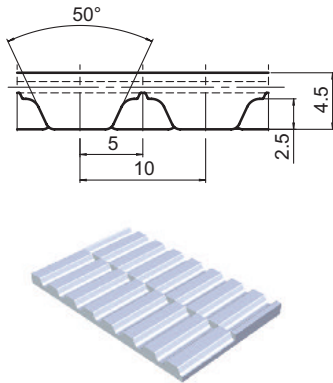

Belt characteristics

- Polyurethane timing belt with steel tension cords.
- Metric pitch 10 mm
- Tooth profile and dimension are optimised to guarantee uniform load distribution and minimum deformation under load
- High resistance and low stretch steel cords to guarantee high stability and low elongation
- Reduced polygonal effect with reduced drive vibration
- Particularly suitable for linear drives and medium power transmission applications with high axial and angular positioning accuracy
- Negative length tolerance available on request

- Width tolerance: $\pm 0,5$ [mm]
- Length tolerance: $\pm 0,5$ [mm/m]
- Thickness tolerance: $\pm 0,2$ [mm]

Technical Data

Belt width b [mm]	Allowable tensile load Type M F_{Tzul} [N]	Allowable tensile load Type V F_{Tzul} [N]	Breaking load Type M F_{Br} [N]	Specific spring rate C_{spez} [N]	Weight [kg/m]
50	8330	4165	32300	2082500	0,29
75	12740	6370	49400	3185000	0,43
100	17150	8575	66500	4287500	0,57

Other widths are available on request.

Load / Elongation [%]

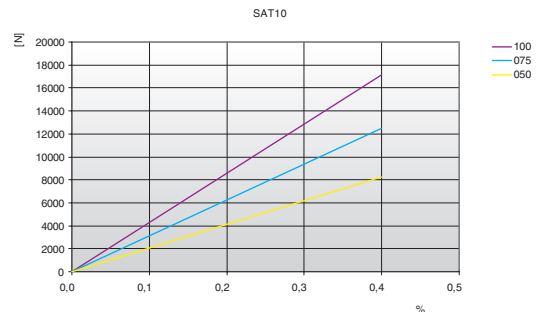

Tooth shear strength

rpm	F_{Uspez} [N/cm]	rpm	F_{Uspez} [N/cm]	rpm	F_{Uspez} [N/cm]	rpm	F_{Uspez} [N/cm]
0	88,57	800	62,83	1900	49,16	4500	34,08
20	87,06	900	61,09	2000	48,29	5000	32,17
40	85,66	1000	59,49	2200	46,67	5500	30,43
60	84,35	1100	58,02	2400	45,18	6000	28,84
80	83,13	1200	56,66	2600	43,80	6500	27,37
100	81,99	1300	55,39	2800	42,51	7000	26,01
200	77,36	1400	54,20	3000	41,30	7500	24,73
300	75,09	1440	53,74	3200	40,17	8000	23,53
400	71,99	1500	53,08	3400	39,09	8500	22,41
500	69,27	1600	52,02	3600	38,08	9000	21,34
600	66,88	1700	51,02	3800	37,11	9500	20,33
700	64,75	1800	50,06	4000	36,20	10000	19,37

Tooth shear strength / rpm

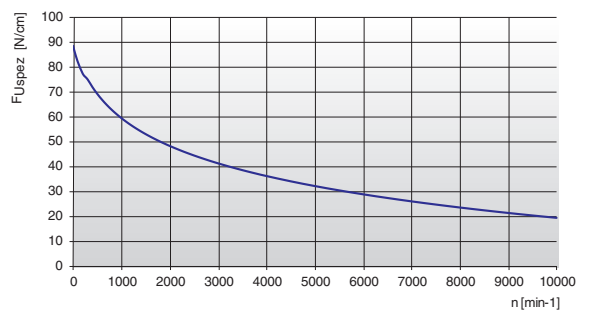

The specific load F_{Uspez} is the maximum load which one single belt tooth 1 cm wide can withstand in all operating conditions. This force is related to the drive rpm. The total load F_u transmissible by the belt in the drive is calculated by:



$$F_u [N] = F_{Uspez} \cdot z_e \cdot b$$

- F_u [N] = peripheral force
- F_{Uspez} [N/cm] = specific load
- z_e = number of teeth in mesh in the small pulley
- z_{emax} = max. no of teeth in mesh to be considered for the calculation of the drive
- z_{emax} = 12 for ELATECH® M
- z_{emax} = 6 for ELATECH® V
- b [cm] = belt width in cm

Specialties

Belt width b [mm]	STAINLESS STEEL		HFE High Flexibility	
	F_{Tzul} [N] M type	F_{Br} [N]	F_{Tzul} [N] M type	F_{Br} [N]
50	6300	26250	7000	29750

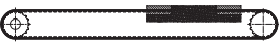
Flexibility

Minimum pulley number of teeth and minimum idler diameter		Type of cord			
		STANDARD	ARAMID	STAINLESS	HFE
Drive without reverse bending 	Timing pulley z_{min}	15	15	20	12
	Flat idler running on belt teeth d_{min}	50 mm	50 mm	70 mm	50 mm
Drive with reverse bending 	Timing pulley z_{min}	25	20	40	20
	Flat idler running on belt back d_{min}	120 mm	120 mm	120 mm	80 mm

Timing pulleys

z	da	dw	z	da	dw	z	da	dw	z	da	dw
15	45,70	47,75	45	141,40	143,24	75	236,90	238,72	105	332,35	334,21
16	49,05	50,93	46	144,55	146,42	76	240,05	241,94	106	335,55	337,40
17	52,25	54,11	47	147,75	149,60	77	243,25	245,09	107	338,75	340,58
18	55,45	57,29	48	150,95	152,78	78	246,40	248,24	108	341,90	343,76
19	58,60	60,48	49	154,10	155,97	79	249,60	251,46	109	345,10	346,95
20	61,80	63,66	50	157,30	159,15	80	252,80	254,64	110	348,30	350,13
21	65,00	66,84	51	160,50	162,33	81	255,95	257,82	111	351,45	353,31
22	68,15	70,03	52	163,65	165,52	82	259,15	261,00	112	354,65	356,50
23	71,35	73,20	53	166,85	168,70	83	262,30	264,19	113	357,80	359,68
24	74,55	76,39	54	170,05	171,88	84	265,50	267,37	114	361,00	362,86
25	77,70	79,58	55	173,20	175,06	85	268,70	270,52	115	364,19	366,04
26	80,90	82,76	56	176,40	178,25	86	271,90	273,74	116	367,39	369,23
27	84,10	85,95	57	179,60	181,43	87	275,05	276,92	117	370,56	372,41
28	87,25	89,12	58	182,75	184,61	88	278,25	280,10	118	373,74	375,59
29	90,45	92,21	59	185,95	187,80	89	281,45	283,28	119	376,93	378,78
30	93,65	95,49	60	189,10	190,98	90	284,60	286,47	120	380,11	381,96
31	96,80	98,67	61	192,30	194,16	91	287,80	289,65			
32	100,00	101,86	62	195,50	197,35	92	291,00	292,84			
33	103,20	105,04	63	198,65	200,53	93	294,20	296,02			
34	106,40	108,19	64	201,85	203,71	94	297,35	299,20			
35	109,55	111,41	65	205,05	206,90	95	300,55	302,39			
36	112,75	114,59	66	208,20	210,08	96	303,70	305,57			
37	115,90	117,77	67	211,40	213,26	97	306,90	308,75			
38	119,10	120,95	68	214,60	216,44	98	310,10	311,93			
39	122,30	124,14	69	217,75	219,63	99	313,25	315,12			
40	125,45	127,32	70	220,95	222,81	100	316,45	318,30			
41	128,65	130,50	71	224,15	225,99	101	319,65	321,48			
42	131,85	133,69	72	227,30	229,18	102	322,80	324,66			
43	135,00	136,87	73	230,50	232,33	103	326,00	327,85			
44	138,20	140,05	74	233,70	235,54	104	329,20	331,03			

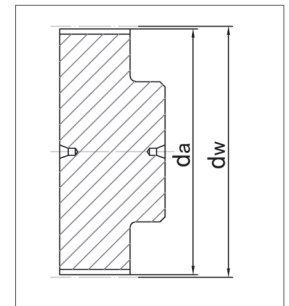

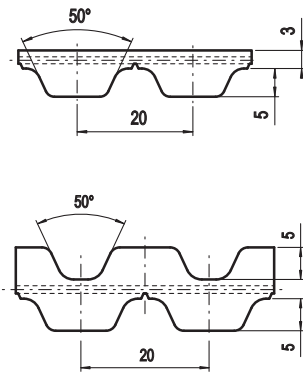

Belt characteristics

- Polyurethane timing belt with steel tension cords
- Metric pitch 20 mm
- Tooth profile and dimension are optimised to guarantee uniform load distribution and minimum deformation under load
- High resistance and low stretch steel cords to guarantee high stability and low elongation
- Reduced polygonal effect with reduced drive vibration.
- Particularly suitable for linear drives and heavy power transmission applications with high axial and angular positioning accuracy
- Double sided tooth construction available

- Width tolerance: $\pm 1,0$ [mm]
- Length tolerance: $\pm 0,5$ [mm/m]
- Thickness tolerance: $\pm 0,4$ [mm]

Technical Data

Belt width b [mm]	Allowable tensile load Type M F_{Tzul} [N]	Allowable tensile load Type V F_{Tzul} [N]	Breaking load Type M F_{Br} [N]	Specific spring rate C_{spez} [N]	Weight [kg/m]
25	5280	2640	19250	1320000	0,24
32	7200	3600	26250	1800000	0,31
50	11520	5760	42000	2880000	0,48
75	17280	8640	63000	4320000	0,73
100	23520	11760	85750	5880000	0,97
150	35520	17760	129500	8880000	1,45

Load / Elongation [%]

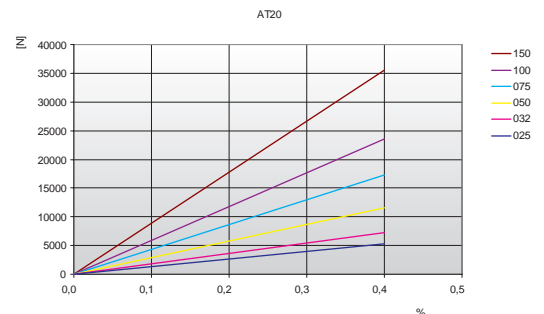

Other widths are available on request.

Tooth shear strength

rpm	F_{Uspez} [N/cm]	rpm	F_{Uspez} [N/cm]	rpm	F_{Uspez} [N/cm]	rpm	F_{Uspez} [N/cm]
0	151,40	800	97,44	1900	69,96	4500	39,72
20	148,56	900	93,93	2000	68,22	5000	35,90
40	145,89	1000	90,73	2200	64,97	5500	32,42
60	143,38	1100	87,77	2400	61,98	6000	29,23
80	141,01	1200	85,02	2600	59,20	6500	26,29
100	138,78	1300	82,47	2800	56,62	-	-
200	129,43	1400	80,07	3000	54,20	-	-
300	122,28	1440	79,16	3200	51,92	-	-
400	115,96	1500	77,82	3400	49,77	-	-
500	110,45	1600	75,70	3600	47,74	-	-
600	105,61	1700	73,69	3800	45,80	-	-
700	101,31	1800	71,77	4000	43,96	-	-

Tooth shear strength / rpm

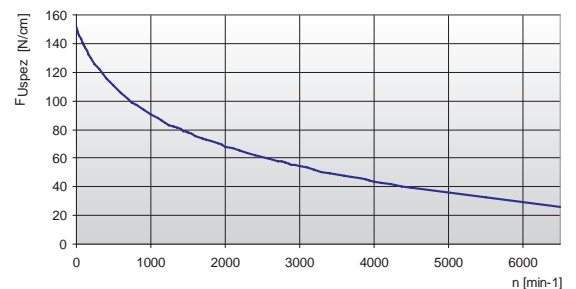



The specific load F_{Uspez} is the maximum load which one single belt tooth 1 cm wide can withstand in all operating conditions. This force is related to the drive rpm. The total load F_U transmissible by the belt in the drive is calculated by:

$$F_U \text{ [N]} = F_{Uspez} \cdot Z_e \cdot b$$

- F_U [N] = peripheral force
- F_{Uspez} [N/cm] = specific load
- Z_e = number of teeth in mesh in the small pulley
- Z_{emax} = max. no of teeth in mesh to be considered for the calculation of the drive
- Z_{emax} = 12 for ELATECH® M
- Z_{emax} = 6 for ELATECH® V
- b [cm] = belt width in cm

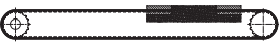
Flexibility

Minimum pulley number of teeth and minimum idler diameter		Type of cord
		STANDARD
Drive without reverse bending 	Timing pulley z_{min}	18
	Flat idler running on belt teeth d_{min}	120 mm
Drive with reverse bending 	Timing pulley z_{min}	25
	Flat idler running on belt back d_{min}	180 mm

Timing pulleys

z	da	dw	z	da	dw	z	da	dw	z	da	dw
18	111,75	114,59	48	302,70	305,58	78	493,70	496,56	108	684,70	687,54
19	118,10	120,95	49	309,10	311,93	79	500,05	502,91	109	691,05	693,89
20	124,50	127,32	50	315,45	318,30	80	506,45	509,28	110	697,40	700,26
21	130,75	133,69	51	321,80	324,67	81	512,80	515,65	111	703,80	706,63
22	137,20	140,05	52	328,20	331,03	82	519,15	522,02	112	710,15	712,99
23	143,55	146,42	53	334,55	337,40	83	525,55	528,39	113	716,50	719,36
24	149,95	152,78	54	340,90	343,76	84	531,90	534,74	114	722,90	725,72
25	156,30	159,15	55	347,30	350,13	85	538,25	541,11	115	729,24	732,09
26	162,65	165,52	56	353,65	356,50	86	544,60	547,48	116	735,61	738,46
27	169,05	171,88	57	360,00	362,86	87	551,00	553,85	117	741,96	744,83
28	175,40	178,25	58	366,40	369,23	88	557,35	560,22	118	748,34	751,19
29	181,75	184,62	59	372,75	375,59	89	563,70	566,57	119	754,70	757,56
30	188,15	190,99	60	379,10	381,96	90	570,10	572,94	120	761,07	763,93
31	194,50	197,35	61	385,45	388,33	91	576,45	579,31			
32	200,85	203,72	62	391,85	394,69	92	582,85	585,67			
33	207,20	210,09	63	398,20	401,06	93	589,20	592,04			
34	213,60	216,44	64	404,55	407,43	94	595,55	598,40			
35	219,95	222,81	65	410,95	413,79	95	601,90	604,77			
36	226,35	229,18	66	417,30	420,16	96	608,30	611,14			
37	232,70	235,54	67	423,65	426,52	97	614,65	617,50			
38	239,05	241,91	68	430,05	432,89	98	621,00	623,87			
39	245,45	248,27	69	436,40	439,26	99	627,35	630,24			
40	251,80	254,64	70	442,80	445,63	100	633,75	636,60			
41	258,15	261,01	71	449,15	451,99	101	640,10	642,97			
42	264,50	267,37	72	455,50	458,36	102	646,50	649,34			
43	270,90	273,74	73	461,85	464,73	103	652,85	655,71			
44	277,25	280,10	74	468,25	471,08	104	659,20	662,06			
45	283,60	286,47	75	474,60	477,45	105	665,60	668,43			
46	290,00	292,84	76	480,95	483,82	106	671,95	674,80			
47	296,35	299,21	77	487,35	490,19	107	678,30	681,17			

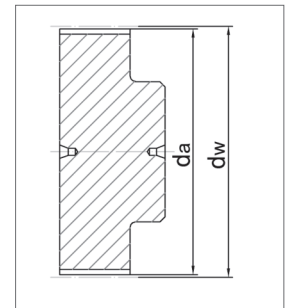

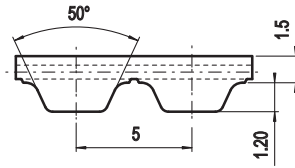

Belt characteristics

- High performance polyurethane timing belt with HPL steel tension cords
- Metric pitch 5 mm
- Specially designed for linear drives
- Tension cords with increased allowable tensile load compared to standard for lower elongation
- Produced with special pretension and pitch tolerance to guarantee high positioning precision in linear drives
- Negative length tolerance available on request

- Width tolerance: $\pm 0,5$ [mm]
- Thickness tolerance: $\pm 0,2$ [mm]

Technical Data

Belt width b [mm]	Allowable tensile load Type M F_{Tzul} [N]	Breaking load Type M F_{Br} [N]	Specific spring rate C_{spez} [N]	Weight [kg/m]
10	920	3360	230000	0,04
16	1610	5880	402500	0,06
25	2650	9660	662500	0,10
32	3450	12600	862500	0,12
50	5520	20160	1380000	0,19
75	8400	30660	2100000	0,29
100	11270	41160	2817500	0,38

Other widths are available on request.

Load / Elongation [%]

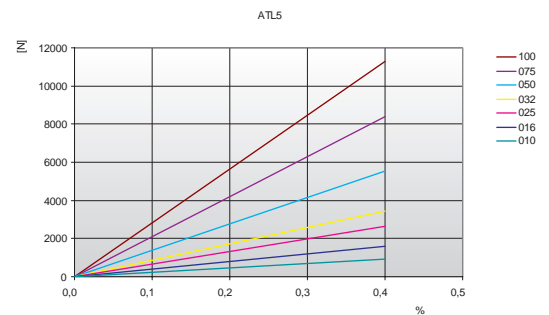

Tooth shear strength

rpm	F_{Uspez} [N/cm]	rpm	F_{Uspez} [N/cm]	rpm	F_{Uspez} [N/cm]	rpm	F_{Uspez} [N/cm]
0	36,40	800	27,69	1900	22,73	4500	17,18
20	35,88	900	27,06	2000	22,42	5000	16,47
40	35,40	1000	26,49	2200	21,82	5500	15,83
60	34,97	1100	25,96	2400	21,28	6000	15,24
80	34,59	1200	25,47	2600	20,77	6500	14,69
100	34,24	1300	25,01	2800	20,29	7000	14,18
200	32,92	1400	24,57	3000	19,85	7500	13,71
300	31,92	1440	24,41	3200	19,43	8000	13,26
400	30,89	1500	24,16	3400	19,03	8500	12,85
500	29,95	1600	23,78	3600	18,66	9000	12,45
600	29,12	1700	23,41	3800	18,30	9500	12,07
700	28,37	1800	23,07	4000	17,96	10000	11,72

Tooth shear strength / rpm

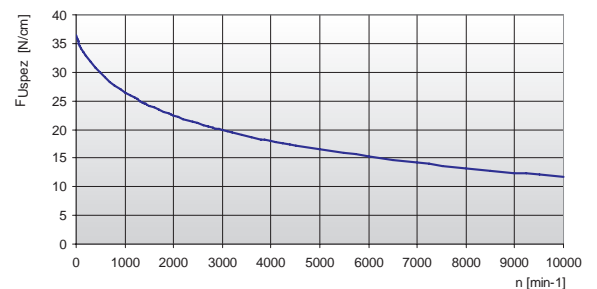



The specific load F_{Uspez} is the maximum load which one single belt tooth 1 cm wide can withstand in all operating conditions. This force is related to the drive rpm. The total load F_U transmissible by the belt in the drive is calculated by:

$$F_U [N] = F_{Uspez} \cdot Z_e \cdot b$$

- $F_U [N]$ = peripheral force
- $F_{Uspez} [N/cm]$ = specific load
- Z_e = number of teeth in mesh in the small pulley
- Z_{emax} = max. no of teeth in mesh to be considered for the calculation of the drive
- Z_{emax} = 12 for ELATECH® M
- Z_{emax} = 6 for ELATECH® V
- $b [cm]$ = belt width in cm

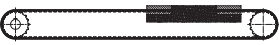
Flexibility

Minimum pulley number of teeth and minimum idler diameter		Type of cord
		STANDARD
Drive without reverse bending 	Timing pulley z_{min}	25
	Flat idler running on belt teeth d_{min}	40 mm
Drive with reverse bending 	Timing pulley z_{min}	25
	Flat idler running on belt back d_{min}	60 mm

Timing pulleys

z	da	dw	z	da	dw	z	da	dw	z	da	dw
15	22,65	23,88	45	70,40	71,64	75	118,15	119,40	105	165,90	167,16
16	24,20	25,47	46	72,00	73,23	76	119,75	120,99	106	167,50	168,75
17	25,80	27,06	47	73,55	74,82	77	121,35	122,58	107	169,10	170,34
18	27,40	28,65	48	75,15	76,42	78	122,90	124,18	108	170,70	171,94
19	29,00	30,25	49	76,75	78,01	79	124,50	125,77	109	172,25	173,53
20	30,60	31,83	50	78,35	79,60	80	126,10	127,36	110	173,85	175,12
21	32,20	33,43	51	79,95	81,19	81	127,70	128,95	111	175,45	176,71
22	33,80	35,02	52	81,55	82,78	82	129,30	130,54	112	177,05	178,30
23	35,40	36,62	53	83,10	84,38	83	130,90	132,14	113	178,65	179,84
24	37,00	38,21	54	84,70	85,97	84	132,45	133,73	114	180,25	181,49
25	38,60	39,80	55	86,30	87,54	85	134,05	135,32	115	181,85	183,08
26	40,20	41,39	56	87,90	89,15	86	135,65	136,91	116	183,45	184,67
27	41,80	42,98	57	89,50	90,74	87	137,25	138,50	117	185,00	186,26
28	43,35	44,58	58	91,10	92,34	88	138,85	140,10	118	186,60	187,86
29	44,95	46,17	59	92,65	93,93	89	140,45	141,69	119	188,20	189,45
30	46,55	47,76	60	94,25	95,52	90	142,05	143,28	120	189,80	191,04
31	48,15	49,35	61	95,85	97,11	91	143,60	144,87			
32	49,70	50,94	62	97,45	98,70	92	145,20	146,46			
33	51,30	52,54	63	99,05	100,30	93	146,80	148,06			
34	52,85	54,13	64	100,65	101,89	94	148,40	149,65			
35	54,45	55,72	65	102,25	103,48	95	150,00	151,24			
36	56,05	57,31	66	103,80	105,07	96	151,60	152,83			
37	57,65	58,90	67	105,40	106,66	97	153,15	154,42			
38	59,25	60,50	68	107,00	108,26	98	154,75	156,02			
39	60,85	62,09	69	108,60	109,85	99	156,35	157,61			
40	62,45	63,66	70	110,20	111,44	100	157,95	159,20			
41	64,00	65,27	71	111,80	113,03	101	159,55	160,79			
42	65,60	66,86	72	113,35	114,62	102	161,15	162,38			
43	67,30	68,46	73	114,95	116,22	103	162,70	163,97			
44	68,80	70,05	74	116,55	117,81	104	164,30	165,57			

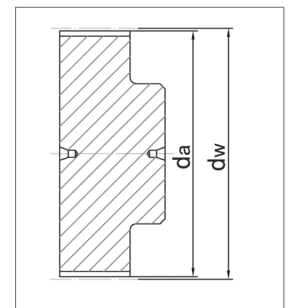

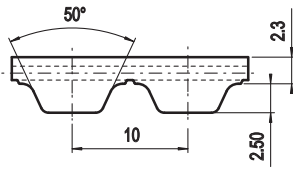

Belt characteristics

- High performance polyurethane timing belt with HPL steel tension cords
- Metric pitch 10 mm
- Specially designed for linear drives
- Tension cords with increased allowable tensile load compared to standard for lower elongation
- Produced with special pretension and pitch tolerance to guarantee high positioning precision in linear drives
- Negative length tolerance available on request

- Width tolerance: $\pm 0,5$ [mm]
- Thickness tolerance: $\pm 0,2$ [mm]

Technical Data

Belt width b [mm]	Allowable tensile load Type M F_{Tzul} [N]	Breaking load Type M F_{Br} [N]	Specific spring rate C_{spez} [N]	Weight [kg/m]
16	3840	14000	960000	0,11
25	6720	24500	1680000	0,17
32	8640	31500	2160000	0,22
50	14400	52500	3600000	0,35
75	21600	78750	5400000	0,52
100	29280	106750	7320000	0,69
150	44160	161000	11040000	0,85

Other widths are available on request.

Load / Elongation [%]

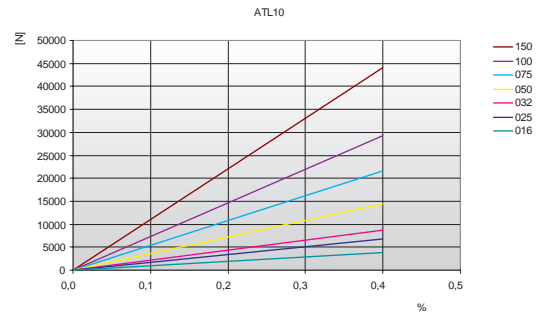

Tooth shear strength

rpm	F_{Uspez} [N/cm]	rpm	F_{Uspez} [N/cm]	rpm	F_{Uspez} [N/cm]	rpm	F_{Uspez} [N/cm]
0	88,57	800	62,83	1900	49,16	4500	34,08
20	87,06	900	61,09	2000	48,29	5000	32,17
40	85,66	1000	59,49	2200	46,67	5500	30,43
60	84,35	1100	58,02	2400	45,18	6000	28,84
80	83,13	1200	56,66	2600	43,80	6500	27,37
100	81,99	1300	55,39	2800	42,51	7000	26,01
200	77,36	1400	54,20	3000	41,30	7500	24,73
300	75,09	1440	53,74	3200	40,17	8000	23,53
400	71,99	1500	53,08	3400	39,09	8500	22,41
500	69,27	1600	52,02	3600	38,08	9000	21,34
600	66,88	1700	51,02	3800	37,11	9500	20,33
700	64,75	1800	50,06	4000	36,20	10000	19,37

Tooth shear strength / rpm

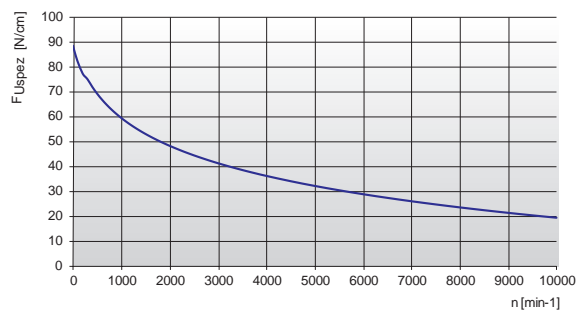

The specific load F_{Uspez} is the maximum load which one single belt tooth 1 cm wide can withstand in all operating conditions. This force is related to the drive rpm. The total load F_u transmissible by the belt in the drive is calculated by:

$$F_u [N] = F_{Uspez} \cdot z_e \cdot b$$

- F_u [N] = peripheral force
- F_{Uspez} [N/cm] = specific load
- z_e = number of teeth in mesh in the small pulley
- z_{emax} = max. no of teeth in mesh to be considered for the calculation of the drive
- z_{emax} = 12 for ELATECH® M
- z_{emax} = 6 for ELATECH® V
- b [cm] = belt width in cm

Flexibility

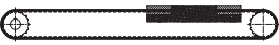
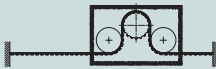
Minimum pulley number of teeth and minimum idler diameter		Type of cord
		STANDARD
Drive without reverse bending 	Timing pulley z_{min}	25
	Flat idler running on belt teeth d_{min}	80 mm
Drive with reverse bending 	Timing pulley z_{min}	25
	Flat idler running on belt back d_{min}	150 mm

Timing pulleys

z	da	dw	z	da	dw	z	da	dw	z	da	dw
18	55,45	57,29	48	150,95	152,78	78	246,40	248,24	108	341,90	343,76
19	58,60	60,48	49	154,10	155,97	79	249,60	251,46	109	345,10	346,95
20	61,80	63,66	50	157,30	159,15	80	252,80	254,64	110	348,30	350,13
21	65,00	66,84	51	160,50	162,33	81	255,95	257,82	111	351,45	353,31
22	68,15	70,03	52	163,65	165,52	82	259,15	261,00	112	354,65	356,50
23	71,35	73,20	53	166,85	168,70	83	262,30	264,19	113	357,80	359,68
24	74,55	76,39	54	170,05	171,88	84	265,50	267,37	114	361,00	362,86
25	77,70	79,58	55	173,20	175,06	85	268,70	270,52	115	364,19	366,04
26	80,90	82,76	56	176,40	178,25	86	271,90	273,74	116	367,39	369,23
27	84,10	85,95	57	179,60	181,43	87	275,05	276,92	117	370,56	372,41
28	87,25	89,12	58	182,75	184,61	88	278,25	280,10	118	373,74	375,59
29	90,45	92,21	59	185,95	187,80	89	281,45	283,28	119	376,93	378,78
30	93,65	95,49	60	189,10	190,98	90	284,60	286,47	120	380,11	381,96
31	96,80	98,67	61	192,30	194,16	91	287,80	289,65			
32	100,00	101,86	62	195,50	197,35	92	291,00	292,84			
33	103,20	105,04	63	198,65	200,53	93	294,20	296,02			
34	106,40	108,19	64	201,85	203,71	94	297,35	299,20			
35	109,55	111,41	65	205,05	206,90	95	300,55	302,39			
36	112,75	114,59	66	208,20	210,08	96	303,70	305,57			
37	115,90	117,77	67	211,40	213,26	97	306,90	308,75			
38	119,10	120,95	68	214,60	216,44	98	310,10	311,93			
39	122,30	124,14	69	217,75	219,63	99	313,25	315,12			
40	125,45	127,32	70	220,95	222,81	100	316,45	318,30			
41	128,65	130,50	71	224,15	225,99	101	319,65	321,48			
42	131,85	133,69	72	227,30	229,18	102	322,80	324,66			
43	135,00	136,87	73	230,50	232,33	103	326,00	327,85			
44	138,20	140,05	74	233,70	235,54	104	329,20	331,03			
45	141,40	143,24	75	236,90	238,72	105	332,35	334,21			
46	144,55	146,42	76	240,05	241,94	106	335,55	337,40			
47	147,75	149,60	77	243,25	245,09	107	338,75	340,58			

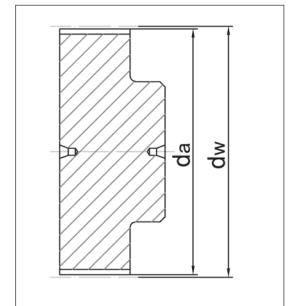

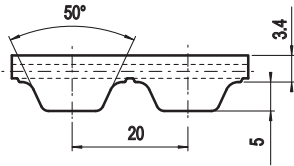

Belt characteristics

- High performance polyurethane timing belt with HPL steel tension cords
- Metric pitch 20 mm
- Specially designed for linear drives
- Tension cords with increased allowable tensile load compared to standard for lower elongation
- Produced with special pretension and pitch tolerance to guarantee high positioning precision in linear drives

- Width tolerance: $\pm 1,0$ [mm]
- Thickness tolerance: $\pm 0,4$ [mm]

Technical Data

Belt width b [mm]	Allowable tensile load Type M F_{Tzul} [N]	Breaking load Type M F_{Br} [N]	Specific spring rate C_{spez} [N]	Weight [kg/m]
25	7650	28800	1912500	0,28
32	10200	38400	2550000	0,36
50	16150	60800	4037500	0,56
75	24650	92800	6162500	0,84
100	33150	124800	8287500	1,12
150	51000	192000	12750000	1,68
200	68000	256000	17000000	2,25

Other widths are available on request.

Load / Elongation [%]

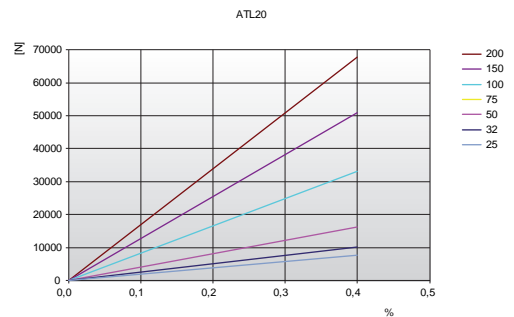

Tooth shear strength

rpm	F_{Uspez} [N/cm]	rpm	F_{Uspez} [N/cm]	rpm	F_{Uspez} [N/cm]	rpm	F_{Uspez} [N/cm]
0	151,40	800	97,44	1900	69,96	4500	39,72
20	148,56	900	93,93	2000	68,22	5000	35,90
40	145,89	1000	90,73	2200	64,97	5500	32,42
60	143,38	1100	87,77	2400	61,98	6000	29,23
80	141,01	1200	85,02	2600	59,20	6500	26,29
100	138,78	1300	82,47	2800	56,62	-	-
200	129,43	1400	80,07	3000	54,20	-	-
300	122,28	1440	79,16	3200	51,92	-	-
400	115,96	1500	77,82	3400	49,77	-	-
500	110,45	1600	75,70	3600	47,74	-	-
600	105,61	1700	73,69	3800	45,80	-	-
700	101,31	1800	71,77	4000	43,96	-	-

Tooth shear strength / rpm

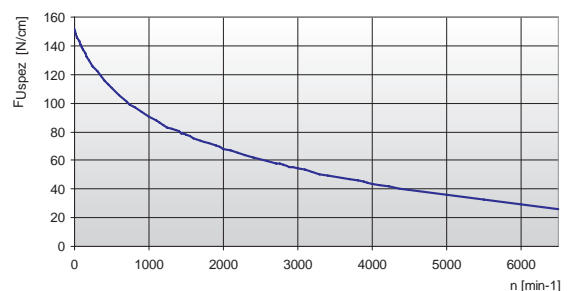



The specific load F_{Uspez} is the maximum load which one single belt tooth 1 cm wide can withstand in all operating conditions. This force is related to the drive rpm. The total load F_U transmissible by the belt in the drive is calculated by:

$$F_U [N] = F_{Uspez} \cdot Z_e \cdot b$$

- $F_U [N]$ = peripheral force
- $F_{Uspez} [N/cm]$ = specific load
- Z_e = number of teeth in mesh in the small pulley
- Z_{emax} = max. no of teeth in mesh to be considered for the calculation of the drive
- Z_{emax} = 12 for ELATECH® M
- Z_{emax} = 6 for ELATECH® V
- $b [cm]$ = belt width in cm

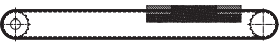
Flexibility

Minimum pulley number of teeth and minimum idler diameter		Type of cord
		STANDARD
Drive without reverse bending 	Timing pulley z_{min}	25
	Flat idler running on belt teeth d_{min}	160 mm
Drive with reverse bending 	Timing pulley z_{min}	25
	Flat idler running on belt back d_{min}	250 mm

Timing pulleys

z	da	dw	z	da	dw	z	da	dw	z	da	dw
18	111,75	114,59	48	302,70	305,58	78	493,70	496,56	108	684,70	687,54
19	118,10	120,95	49	309,10	311,93	79	500,05	502,91	109	691,05	693,89
20	124,50	127,32	50	315,45	318,30	80	506,45	509,28	110	697,40	700,26
21	130,75	133,69	51	321,80	324,67	81	512,80	515,65	111	703,80	706,63
22	137,20	140,05	52	328,20	331,03	82	519,15	522,02	112	710,15	712,99
23	143,55	146,42	53	334,55	337,40	83	525,55	528,39	113	716,50	719,36
24	149,95	152,78	54	340,90	343,76	84	531,90	534,74	114	722,90	725,72
25	156,30	159,15	55	347,30	350,13	85	538,25	541,11	115	729,24	732,09
26	162,65	165,52	56	353,65	356,50	86	544,60	547,48	116	735,61	738,46
27	169,05	171,88	57	360,00	362,86	87	551,00	553,85	117	741,96	744,83
28	175,40	178,25	58	366,40	369,23	88	557,35	560,22	118	748,34	751,19
29	181,75	184,62	59	372,75	375,59	89	563,70	566,57	119	754,70	757,56
30	188,15	190,99	60	379,10	381,96	90	570,10	572,94	120	761,07	763,93
31	194,50	197,35	61	385,45	388,33	91	576,45	579,31			
32	200,85	203,72	62	391,85	394,69	92	582,85	585,67			
33	207,20	210,09	63	398,20	401,06	93	589,20	592,04			
34	213,60	216,44	64	404,55	407,43	94	595,55	598,40			
35	219,95	222,81	65	410,95	413,79	95	601,90	604,77			
36	226,35	229,18	66	417,30	420,16	96	608,30	611,14			
37	232,70	235,54	67	423,65	426,52	97	614,65	617,50			
38	239,05	241,91	68	430,05	432,89	98	621,00	623,87			
39	245,45	248,27	69	436,40	439,26	99	627,35	630,24			
40	251,80	254,64	70	442,80	445,63	100	633,75	636,60			
41	258,15	261,01	71	449,15	451,99	101	640,10	642,97			
42	264,50	267,37	72	455,50	458,36	102	646,50	649,34			
43	270,90	273,74	73	461,85	464,73	103	652,85	655,71			
44	277,25	280,10	74	468,25	471,08	104	659,20	662,06			
45	283,60	286,47	75	474,60	477,45	105	665,60	668,43			
46	290,00	292,84	76	480,95	483,82	106	671,95	674,80			
47	296,35	299,21	77	487,35	490,19	107	678,30	681,17			

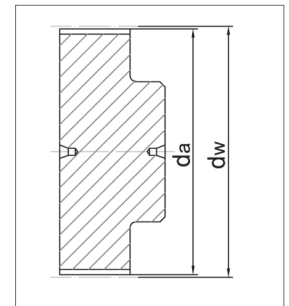

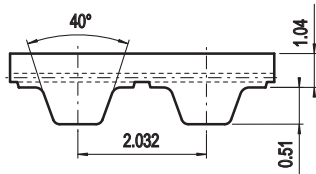

Belt characteristics

- Polyurethane timing belt with trapezoidal tooth profile according to DIN/ISO 5296 with steel tension cords
- Imperial pitch 2/25" = 2,032 mm
- Allow to use small diameter pulley
- Mainly used in applications where inch pitch is an advantage (USA / UK)
- Transparent (natural) PU colour

- Width tolerance: ±0,5 [mm]
- Length tolerance: ±0,8 [mm/m]
- Thickness tolerance: ±0,1 [mm]

Technical Data

Belt width b Code / mm	Allowable tensile load Type M F _{Tzul} [N]	Allowable tensile load Type V F _{Tzul} [N]	Breaking load Type M F _{Br} [N]	Specific spring rate C _{spez} [N]	Weight [kg/m]
025 / 6,35	220	110	875	55000	0,014
050 / 12,7	450	225	1750	112500	0,025
100 / 25,4	900	450	3500	225000	0,050
200 / 50,8	1790	895	7000	447500	0,095
400 / 101,6	3580	1790	14000	895000	0,190

Other widths are available on request.

Load / Elongation [%]

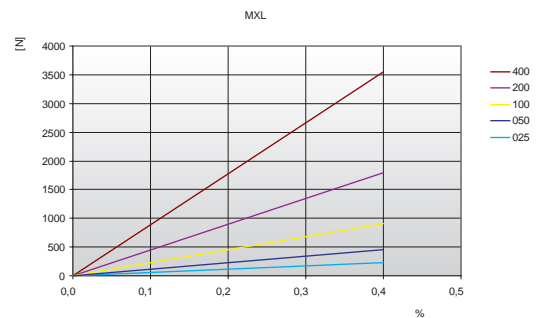

Tooth shear strength

rpm	F _{Uspez} [N/cm]	rpm	F _{Uspez} [N/cm]	rpm	F _{Uspez} [N/cm]	rpm	F _{Uspez} [N/cm]
0	7,58	800	4,99	1900	4,21	4500	3,41
20	7,31	900	4,88	2000	4,16	5000	3,31
40	7,09	1000	4,79	2200	4,07	5500	3,22
60	6,92	1100	4,70	2400	3,99	6000	3,14
80	6,78	1200	4,62	2600	3,92	6500	3,06
100	6,67	1300	4,55	2800	3,85	7000	2,99
200	6,15	1400	4,48	3000	3,78	7500	2,93
300	5,83	1440	4,46	3200	3,72	8000	2,86
400	5,59	1500	4,42	3400	3,67	8500	2,81
500	5,40	1600	4,36	3600	3,61	9000	2,75
600	5,24	1700	4,31	3800	3,56	9500	2,70
700	5,11	1800	4,25	4000	3,52	10000	2,65

Tooth shear strength / rpm

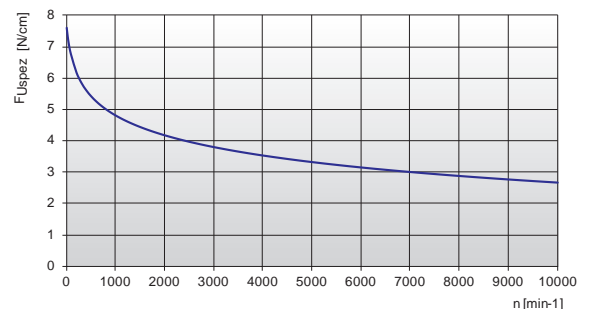

The specific load F_{Uspez} is the maximum load which one single belt tooth 1 cm wide can withstand in all operating conditions.



This force is related to the drive rpm.

The total load F_u transmissible by the belt in the drive is calculated by:

$$F_u [N] = F_{Uspez} \cdot Z_e \cdot b$$

- F_u [N] = peripheral force
- F_{Uspez} [N/cm] = specific load
- Z_e = number of teeth in mesh in the small pulley
- Z_{emax} = max. no of teeth in mesh to be considered for the calculation of the drive
- Z_{emax} = 12 for ELATECH® M
- Z_{emax} = 6 for ELATECH® V
- b [cm] = belt width in cm

Flexibility

Minimum pulley number of teeth and minimum idler diameter		Type of cord
		STANDARD
Drive without reverse bending 	Timing pulley z_{min}	12
	Flat idler running on belt teeth d_{min}	20 mm
Drive with reverse bending 	Timing pulley z_{min}	15
	Flat idler running on belt back d_{min}	25 mm

Timing pulleys

z	da	dw	z	da	dw	z	da	dw	z	da	dw
10	5,96	6,47	44	27,95	28,46	78	49,94	50,45	112	71,93	72,44
11	6,61	7,12	45	28,60	29,11	79	50,59	51,10	113	72,58	73,09
12	7,25	7,76	46	29,24	29,75	80	51,23	51,74	114	73,23	73,74
13	7,90	8,41	47	29,89	30,40	81	51,88	52,39	115	73,87	74,38
14	8,55	9,06	48	30,54	31,05	82	52,53	53,04	116	74,52	75,03
15	9,19	9,70	49	31,18	31,69	83	53,17	53,68	117	75,17	75,68
16	9,84	10,35	50	31,83	32,34	84	53,82	54,33	118	75,81	76,32
17	10,49	11,00	51	32,48	32,99	85	54,47	54,98	119	76,46	76,97
18	11,13	11,64	52	33,12	33,63	86	55,12	55,63	120	77,11	77,62
19	11,78	12,29	53	33,77	34,28	87	55,76	56,27	121	77,75	78,26
20	12,43	12,94	54	34,42	34,93	88	56,41	56,92	122	78,40	78,91
21	13,07	13,58	55	35,06	35,57	89	57,06	57,57	123	79,05	79,56
22	13,72	14,23	56	35,71	36,22	90	57,70	58,21	124	79,69	80,20
23	14,37	14,88	57	36,36	36,87	91	58,36	58,86	125	80,34	80,85
24	15,01	15,52	58	37,00	37,51	92	59,00	59,51	126	80,99	81,50
25	15,66	16,17	59	37,65	38,16	93	59,64	60,15	127	81,63	82,14
26	16,31	16,82	60	38,30	38,81	94	60,29	60,80	128	82,28	82,79
27	16,95	17,46	61	38,95	39,46	95	60,94	61,45	129	82,93	83,44
28	17,60	18,11	62	39,59	40,10	96	61,58	62,09	130	83,57	84,08
29	18,25	18,76	63	40,24	40,75	97	62,23	62,74	131	84,22	84,73
30	18,89	19,40	64	40,89	41,40	98	62,88	63,39	132	84,87	85,38
31	19,54	20,05	65	41,53	42,04	99	63,52	64,03	133	85,51	86,02
32	20,19	20,70	66	42,18	42,69	100	64,17	64,68	134	86,16	86,67
33	20,83	21,34	67	42,83	43,34	101	64,82	65,33	135	86,81	87,32
34	21,48	21,99	68	43,47	43,98	102	65,46	65,97	136	87,46	87,97
35	22,13	22,64	69	44,12	44,63	103	66,11	66,62	137	88,10	88,61
36	22,78	23,29	70	44,77	45,28	104	66,76	67,27	138	88,75	89,26
37	23,42	23,93	71	45,41	45,92	105	67,40	67,91	139	89,40	89,91
38	24,07	24,58	72	46,06	46,57	106	68,05	68,56	140	90,04	90,55
39	24,72	25,23	73	46,71	47,22	107	68,70	69,21			
40	25,36	25,87	74	47,35	47,86	108	69,34	69,85			
41	26,01	26,52	75	48,00	48,51	109	69,99	70,50			
42	26,66	27,17	76	48,65	49,16	110	70,64	71,15			
43	27,30	27,81	77	49,29	49,80	111	71,29	71,80			

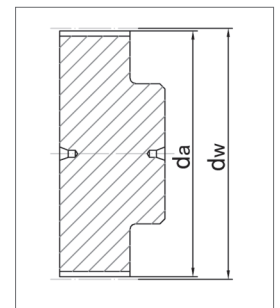

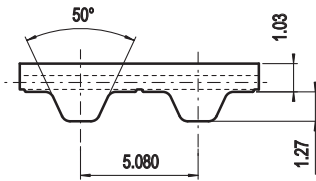

Belt characteristics

- Polyurethane timing belt with trapezoidal tooth profile according to DIN/ISO 5296 with steel tension cords
- Imperial pitch 1/5" = 5,08 mm
- Allow to use small diameter pulley
- Mainly used in applications where inch pitch is an advantage (USA / UK)

- Width tolerance: ±0,5 [mm]
- Length tolerance: ±0,5 [mm/m]
- Thickness tolerance: ±0,2 [mm]

Technical Data

Belt width b Code / mm	Allowable tensile load Type M F _{Tzul} [N]	Allowable tensile load Type V F _{Tzul} [N]	Breaking load Type M F _{Br} [N]	Specific spring rate C _{spez} [N]	Weight [kg/m]
025 / 6,35	190	95	750	47500	0,015
031 / 7,94	260	130	1000	65000	0,019
037 / 9,53	290	145	1125	72500	0,023
050 / 12,7	420	210	1625	105000	0,031
075 / 19,1	670	335	2625	167500	0,046
100 / 25,4	900	450	3500	225000	0,061
150 / 38,1	1410	705	5500	352500	0,092
200 / 50,8	1890	945	7375	472500	0,122
400 / 101,6	3840	1920	15000	960000	0,244

Other widths are available on request.

Tooth shear strength

rpm	F _{Uspez} [N/cm]	rpm	F _{Uspez} [N/cm]	rpm	F _{Uspez} [N/cm]	rpm	F _{Uspez} [N/cm]
0	25,10	800	17,32	1900	14,46	4500	11,45
20	24,46	900	16,94	2000	14,28	5000	11,08
40	23,90	1000	16,60	2200	13,96	5500	10,74
60	23,42	1100	16,29	2400	13,66	6000	10,43
80	23,00	1200	16,01	2600	13,38	6500	10,14
100	22,63	1300	15,74	2800	13,12	7000	9,87
200	21,24	1400	15,49	3000	12,88	7500	9,63
300	20,22	1440	15,40	3200	12,65	8000	9,39
400	19,42	1500	15,26	3400	12,44	8500	9,17
500	18,77	1600	15,04	3600	12,24	9000	8,97
600	18,22	1700	14,84	3800	12,05	9500	8,77
700	17,74	1800	14,64	4000	11,87	10000	8,59

The specific load F_{Uspez} is the maximum load which one single belt tooth 1 cm wide can withstand in all operating conditions. This force is related to the drive rpm. The total load F_u transmissible by the belt in the drive is calculated by:

$$F_u [N] = F_{Uspez} \cdot Z_e \cdot b$$

- F_u [N] = peripheral force
- F_{Uspez} [N/cm] = specific load
- Z_e = number of teeth in mesh in the small pulley
- Z_{e,max} = max. no of teeth in mesh to be considered for the calculation of the drive
- Z_{e,max} = 12 for ELATECH® M
- Z_{e,max} = 6 for ELATECH® V
- b [cm] = belt width in cm

Load / Elongation [%]

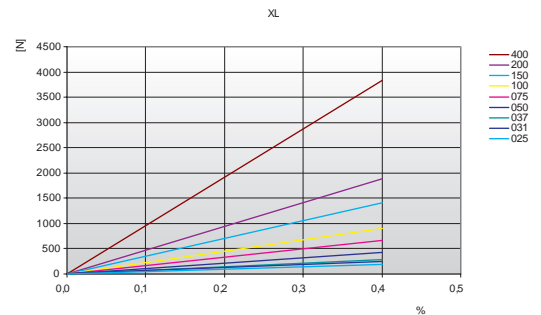

Tooth shear strength / rpm

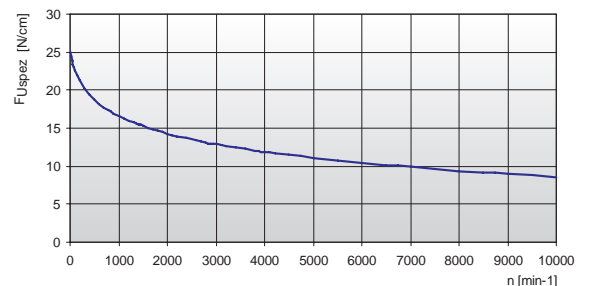

Specialties

Belt width b	ARAMID CORD	
	F_{Tzul} [N] M type	F_{Br} [N]
025 / 6,35	420	1680
031 / 7,94	560	1230
037 / 9,53	630	2520
050 / 12,7	910	3640
075 / 19,1	1470	5880
100 / 25,4	1960	7840
150 / 38,1	3080	12320
200 / 50,8	4130	16520
400 / 101,6	8400	33600

Flexibility

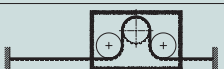
Minimum pulley number of teeth and minimum idler diameter		Type of cord	
		STANDARD	ARAMID
Drive without reverse bending 	Timing pulley z_{min}	10	10
	Flat idler running on belt teeth d_{min}	30 mm	30 mm
Drive with reverse bending 	Timing pulley z_{min}	15	15
	Flat idler running on belt back d_{min}	30 mm	30 mm

Timing pulleys

z	da	dw	z	da	dw	z	da	dw	z	da	dw
10	15,66	16,17	40	64,17	64,68	70	112,68	113,19	100	161,19	161,70
11	17,28	17,79	41	65,79	66,30	71	114,30	114,81	101	162,81	163,32
12	18,89	19,40	42	67,40	67,91	72	115,92	116,43	102	164,42	164,93
13	20,51	21,02	43	69,02	69,53	73	117,53	118,04	103	166,04	166,55
14	22,13	22,64	44	70,64	71,15	74	119,15	119,66	104	167,66	168,17
15	23,74	24,25	45	72,26	72,77	75	120,77	121,28	105	169,28	169,79
16	25,36	25,87	46	73,87	74,38	76	122,38	122,89	106	170,89	171,40
17	26,98	27,49	47	75,49	76,00	77	124,00	124,51	107	172,51	173,02
18	28,60	29,11	48	77,11	77,62	78	125,62	126,13	108	174,13	174,64
19	30,21	30,72	49	78,72	79,23	79	127,23	127,74	109	175,74	176,25
20	31,83	32,34	50	80,34	80,85	80	128,85	129,36	110	177,36	177,87
21	33,45	33,96	51	81,96	82,47	81	130,47	130,98	111	178,98	179,49
22	35,06	35,57	52	83,57	84,08	82	132,08	132,59	112	180,59	181,10
23	36,68	37,19	53	85,19	85,70	83	133,70	134,21	113	182,21	182,72
24	38,30	38,81	54	86,81	87,32	84	135,32	135,83	114	183,83	184,34
25	39,92	40,43	55	88,42	88,93	85	136,93	137,44	115	185,44	185,95
26	41,53	42,04	56	90,04	90,55	86	138,55	139,06	116	187,06	187,57
27	43,15	43,66	57	91,66	92,17	87	140,17	140,68	117	188,68	189,19
28	44,77	45,28	58	93,28	93,79	88	141,75	142,30	118	190,30	190,81
29	46,38	46,89	59	94,89	95,40	89	143,36	143,91	119	191,91	192,42
30	48,00	48,51	60	96,51	97,02	90	145,02	145,53	120	193,53	194,04
31	49,62	50,13	61	98,13	98,64	91	146,64	147,15			
32	51,23	51,74	62	99,74	100,25	92	148,25	148,76			
33	52,85	53,36	63	101,36	101,87	93	149,87	150,38			
34	54,47	54,98	64	102,98	103,49	94	151,49	152,00			
35	56,09	56,60	65	104,60	105,11	95	153,11	153,62			
36	57,70	58,21	66	106,21	106,72	96	154,72	155,23			
37	59,32	59,83	67	107,83	108,34	97	156,34	156,85			
38	60,94	61,45	68	109,45	109,96	98	157,96	158,47			
39	62,55	63,06	69	111,06	111,57	99	159,57	160,08			

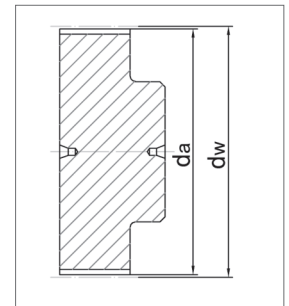

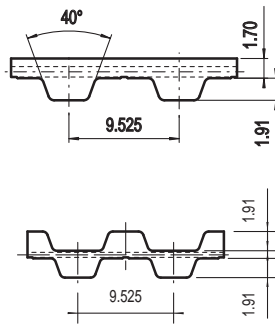

Belt characteristics

- Polyurethane timing belt with trapezoidal tooth profile according to DIN/ISO 5296 with steel tension cords
- Imperial pitch 3/8" = 9,525 mm
- Allow to use small diameter pulley
- Mainly used in applications where inch pitch is an advantage (USA / UK)

- Width tolerance: ±0,5 [mm]
- Length tolerance: ±0,5 [mm/m]
- Thickness tolerance: ±0,2 [mm]

Technical Data

Belt width b Code / mm	Allowable tensile load Type M F _{Tzul} [N]	Allowable tensile load Type V F _{Tzul} [N]	Breaking load Type M F _{Br} [N]	Specific spring rate C _{spez} [N]	Weight [kg/m]
050 / 12,7	1270	635	4620	317500	0,049
075 / 19,1	1960	980	7140	490000	0,073
100 / 25,4	2760	1380	10080	690000	0,098
150 / 38,1	4260	2130	15540	1065000	0,146
200 / 50,8	5640	2820	20580	1410000	0,195
300 / 76,2	8510	4255	31080	2127500	0,293
400 / 101,6	11390	5695	41580	2847500	0,390

Other widths are available on request.

Load / Elongation [%]

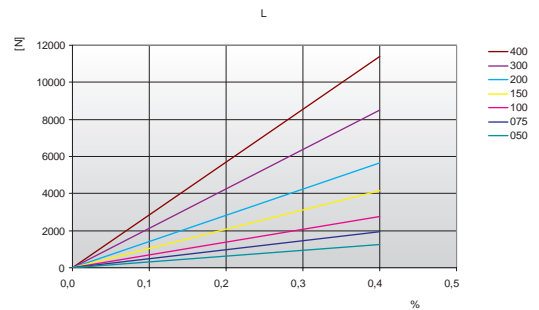

Tooth shear strength

rpm	F _{Uspez} [N/cm]	rpm	F _{Uspez} [N/cm]	rpm	F _{Uspez} [N/cm]	rpm	F _{Uspez} [N/cm]
0	38,6	800	24,7	1900	19,66	4500	14,36
20	37,42	900	24,04	2000	19,35	5000	13,7
40	36,4	1000	23,44	2200	18,77	5500	13,1
60	35,51	1100	22,89	2400	18,24	6000	12,55
80	34,74	1200	22,38	2600	17,76	6500	12,05
100	34,07	1300	21,91	2800	17,3	7000	11,58
200	31,59	1400	21,48	3000	16,88	7500	11,14
300	29,79	1440	21,31	3200	16,48	8000	10,73
400	28,39	1500	21,07	3400	16,1	8500	10,35
500	27,25	1600	20,69	3600	15,75	9000	9,98
600	26,28	1700	20,33	3800	15,41	9500	9,64
700	25,44	1800	19,98	4000	15,09	10000	9,31

Tooth shear strength / rpm

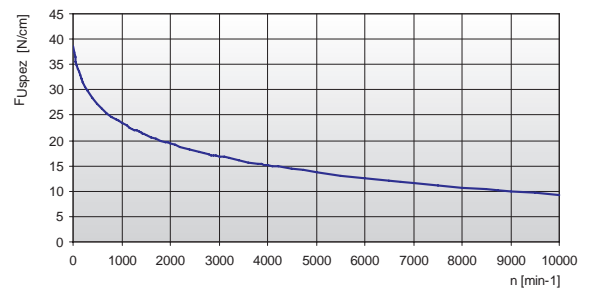

The specific load F_{Uspez} is the maximum load which one single belt tooth 1 cm wide can withstand in all operating conditions.

This force is related to the drive rpm.

The total load F_u transmissible by the belt in the drive is calculated by:



$$F_u [N] = F_{Uspez} \cdot Z_e \cdot b$$

- F_u [N] = peripheral force
- F_{Uspez} [N/cm] = specific load
- Z_e = number of teeth in mesh in the small pulley
- Z_{emax} = max. no of teeth in mesh to be considered for the calculation of the drive
- Z_{emax} = 12 for ELATECH® M
- Z_{emax} = 6 for ELATECH® V
- b [cm] = belt width in cm

Specialties

Belt width b Code / mm	ARAMID CORD		STAINLESS STEEL	
	F _{Tzul} [N] M type	F _{Br} [N]	F _{Tzul} [N] M type	F _{Br} [N]
050 / 12,7	1210	4950	830	3300
075 / 19,1	1870	7650	1280	5100
100 / 25,4	2640	10800	1800	7200
150 / 38,1	4080	16700	2700	10800
200 / 50,8	5390	22050	3680	14700
300 / 76,2	8140	33300	-	-
400 / 101,6	10890	44550	-	-

Flexibility

Minimum pulley number of teeth and minimum idler diameter		Type of cord		
		STANDARD	ARAMID	STAINLESS
Drive without reverse bending 	Timing pulley z _{min}	15	15	18
	Flat idler running on belt teeth d _{min}	60 mm	60 mm	65 mm
Drive with reverse bending 	Timing pulley z _{min}	20	20	20
	Flat idler running on belt back d _{min}	60 mm	60 mm	65 mm

Timing pulleys

z	da	dw	z	da	dw	z	da	dw	z	da	dw
10	29,56	30,32	40	120,52	121,27	70	211,47	212,23	100	302,43	303,18
11	32,59	33,35	41	123,55	124,30	71	214,50	215,26	101	305,46	306,21
12	35,62	36,38	42	126,58	127,33	72	217,53	218,29	102	308,49	309,24
13	38,65	39,41	43	129,61	130,36	73	220,56	221,32	103	311,52	312,29
14	41,68	42,44	44	132,64	133,39	74	223,59	224,35	104	314,55	315,32
15	44,71	45,47	45	135,67	136,44	75	226,62	227,38	105	317,58	318,35
16	47,74	48,50	46	138,70	139,47	76	229,65	230,41	106	320,61	321,38
17	50,77	51,53	47	141,73	142,50	77	232,70	233,46	107	323,64	324,41
18	53,80	54,56	48	144,76	145,53	78	235,73	236,49	108	326,69	327,44
19	56,83	57,61	49	147,80	148,56	79	238,76	239,52	109	329,72	330,47
20	59,88	60,64	50	150,83	151,59	80	241,79	242,55	110	332,75	333,50
21	62,91	63,67	51	153,86	154,62	81	244,82	245,58	111	335,78	336,53
22	65,94	66,70	52	156,89	157,65	82	247,85	248,61	112	338,81	339,56
23	68,97	69,73	53	159,92	160,68	83	250,88	251,64	113	341,84	342,61
24	72,00	72,76	54	162,95	163,71	84	253,91	254,67	114	344,87	345,64
25	75,03	75,80	55	166,00	166,76	85	256,94	257,70	115	347,90	348,67
26	78,06	78,83	56	169,03	169,79	86	259,97	260,73	116	350,93	351,70
27	81,09	81,86	57	172,06	172,82	87	263,02	263,78	117	353,96	354,73
28	84,12	84,89	58	175,09	175,85	88	266,05	266,81	118	357,00	357,76
29	87,15	87,92	59	178,12	178,88	89	269,08	269,84	119	360,03	360,79
30	90,20	90,95	60	181,15	181,91	90	272,11	272,87	120	363,07	363,82
31	93,23	93,98	61	184,18	184,94	91	275,14	275,90			
32	96,26	97,01	62	187,21	187,97	92	278,17	278,93			
33	99,29	100,04	63	190,24	191,00	93	281,20	281,96			
34	102,32	103,07	64	193,27	194,03	94	284,23	285,00			
35	105,35	106,12	65	196,30	197,06	95	287,26	288,03			
36	108,38	109,15	66	199,33	200,11	96	290,30	291,06			
37	111,41	112,18	67	202,38	203,14	97	293,33	294,09			
38	114,44	115,21	68	205,41	206,17	98	296,36	297,12			
39	117,47	118,24	69	208,44	209,20	99	299,40	300,15			

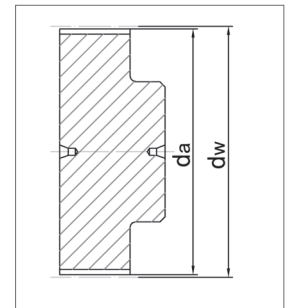

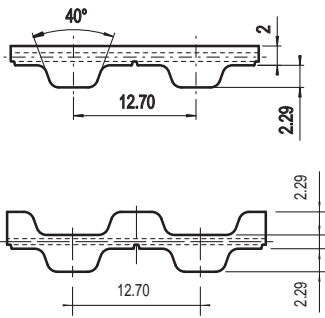

Belt characteristics

- Polyurethane timing belt with trapezoidal tooth profile according to DIN/ISO 5296 with steel tension cords
- Imperial pitch 1/2" = 12,7 mm
- Allow to use small diameter pulley
- Mainly used in applications where inch pitch is an advantage (USA / UK)

- Width tolerance: ±0,5 [mm]
- Length tolerance: ±0,5 [mm/m]
- Thickness tolerance: ±0,2 [mm]

Technical Data

Belt width b Code / mm	Allowable tensile load Type M F _{Tzul} [N]	Allowable tensile load Type V F _{Tzul} [N]	Breaking load Type M F _{Br} [N]	Specific spring rate C _{spez} [N]	Weight [kg/m]
050 / 12,7	1270	635	4620	317500	0,05
075 / 19,1	1960	980	7140	490000	0,08
100 / 25,4	2760	1380	10080	690000	0,11
150 / 38,1	4260	2130	15540	1065000	0,16
200 / 50,8	5640	2820	20580	1410000	0,22
300 / 76,2	8510	4255	31080	2127500	0,32
400 / 101,6	11390	5695	41580	2847500	0,43
600 / 152,4	17370	8685	63420	4342500	0,56
800 / 203,2	11390	5695	41580	2847500	0,65

Other widths are available on request.

Tooth shear strength

rpm	F _{Uspez} [N/cm]	rpm	F _{Uspez} [N/cm]	rpm	F _{Uspez} [N/cm]	rpm	F _{Uspez} [N/cm]
0	45,30	800	29,04	1900	23,11	4500	16,88
20	43,95	900	28,26	2000	22,74	5000	16,11
40	42,78	1000	27,55	2200	22,07	5500	15,41
60	41,77	1100	26,90	2400	21,44	6000	14,76
80	40,88	1200	26,31	2600	20,87	6500	14,17
100	40,11	1300	25,76	2800	20,34	7000	13,62
200	37,22	1400	25,25	3000	19,84	7500	13,11
300	35,07	1440	25,05	3200	19,37	8000	12,63
400	33,41	1500	24,77	3400	18,93	8500	12,18
500	32,05	1600	24,32	3600	18,51	9000	11,75
600	30,90	1700	23,89	3800	18,12	9500	11,35
700	29,91	1800	23,49	4000	17,75	10000	10,96

The specific load F_{Uspez} is the maximum load which one single belt tooth 1 cm wide can withstand in all operating conditions. This force is related to the drive rpm. The total load F_u transmissible by the belt in the drive is calculated by:

$$F_u [N] = F_{Uspez} \cdot Z_e \cdot b$$

- F_u [N] = peripheral force
- F_{Uspez} [N/cm] = specific load
- Z_e = number of teeth in mesh in the small pulley
- Z_{emax} = max. no of teeth in mesh to be considered for the calculation of the drive
- Z_{emax} = 12 for ELATECH® M
- Z_{emax} = 6 for ELATECH® V
- b [cm] = belt width in cm

Load / Elongation [%]

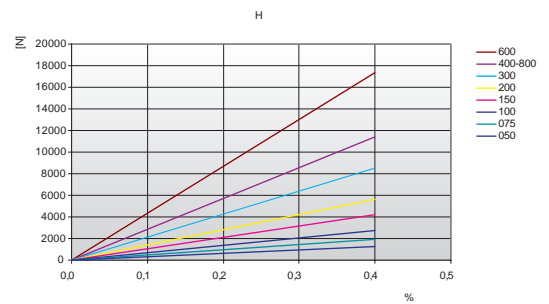

Tooth shear strength / rpm

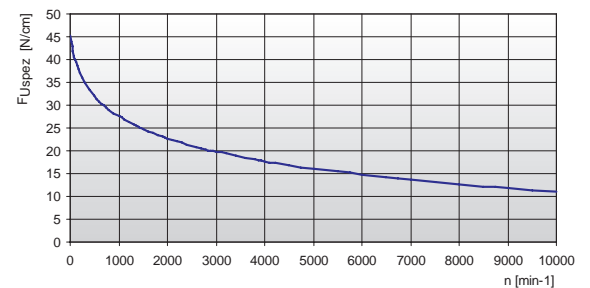

Specialties

Belt width b	ARAMID CORD		STAINLESS STEEL	
	F _{Tzul} [N] M type	F _{Br} [N]	F _{Tzul} [N] M type	F _{Br} [N]
050 / 12,7	1210	4950	830	3300
075 / 19,1	1870	7650	1280	5100
100 / 25,4	2640	10800	1800	7200
150 / 38,1	4100	16700	2700	10800
200 / 50,8	5390	22050	3680	14700
300 / 76,2	8140	33300	-	-
400 / 101,6	10890	44550	-	-
600 / 152,4	16500	67500	-	-
800 / 203,2	11000	45000	-	-

Flexibility

Minimum pulley number of teeth and minimum idler diameter		Type of cord		
		STANDARD	ARAMID	STAINLESS
Drive without reverse bending 	Timing pulley z _{min}	14	14	20
	Flat idler running on belt teeth d _{min}	60 mm	60 mm	80 mm
Drive with reverse bending 	Timing pulley z _{min}	20	20	40
	Flat idler running on belt back d _{min}	80 mm	80 mm	100 mm

Timing pulleys

z	da	dw	z	da	dw	z	da	dw	z	da	dw
14	55,23	56,60	44	176,50	177,86	74	297,78	299,14	104	419,04	420,42
15	59,27	60,64	45	180,54	181,90	75	301,82	303,18	105	423,08	424,46
16	63,31	64,68	46	184,58	185,96	76	305,86	307,22	106	427,14	428,50
17	67,35	68,72	47	188,62	190,00	77	309,90	311,26	107	431,18	432,54
18	71,40	72,76	48	192,67	194,04	78	313,94	315,32	108	435,22	436,58
19	75,44	76,80	49	196,71	198,08	79	317,98	319,36	109	439,26	440,62
20	79,48	80,84	50	200,75	202,13	80	322,02	323,40	110	443,30	444,68
21	83,52	84,88	51	204,80	206,17	81	326,06	327,44	111	447,34	448,72
22	87,57	88,94	52	208,84	210,21	82	330,12	331,48	112	451,38	452,76
23	91,61	92,98	53	212,88	214,25	83	334,16	335,52	113	455,42	456,80
24	95,65	97,02	54	216,92	218,29	84	338,20	339,56	114	459,48	460,84
25	99,69	101,06	55	220,96	222,33	85	342,24	343,60	115	463,52	464,88
26	103,73	105,10	56	225,00	226,37	86	346,28	347,66	116	467,56	468,92
27	107,77	109,14	57	229,04	230,41	87	350,33	351,70	117	471,60	472,96
28	111,81	113,18	58	233,10	234,47	88	354,37	355,74	118	475,64	477,02
29	115,85	117,22	59	237,14	238,51	89	358,41	359,78	119	479,68	481,06
30	119,91	121,28	60	241,18	242,55	90	362,45	363,82	120	483,72	485,10
31	123,95	125,32	61	245,22	246,59	91	366,50	367,86			
32	127,99	129,36	62	249,26	250,63	92	370,54	371,90			
33	132,03	133,40	63	253,30	254,67	93	374,58	375,94			
34	136,07	137,44	64	257,34	258,71	94	378,62	380,00			
35	140,11	141,48	65	261,38	262,75	95	382,66	384,04			
36	144,15	145,52	66	265,44	266,81	96	386,70	388,08			
37	148,20	149,56	67	269,48	270,85	97	390,74	392,12			
38	152,24	153,62	68	273,52	274,89	98	394,80	396,16			
39	156,28	157,66	69	277,56	278,93	99	398,84	400,20			
40	160,32	161,70	70	281,60	282,97	100	402,88	404,24			
41	164,36	165,74	71	285,64	287,01	101	406,92	408,28			
42	168,42	169,78	72	289,68	291,05	102	410,96	412,34			
43	172,46	173,82	73	293,72	295,10	103	415,00	416,38			

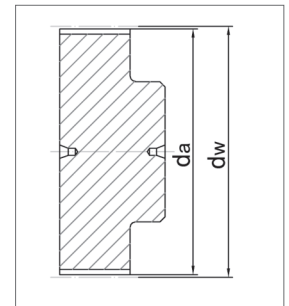

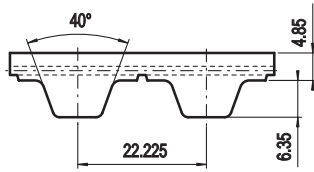

Belt characteristics

- Polyurethane timing belt with trapezoidal tooth profile according to DIN/ISO 5296 with steel tension cords
- Imperial pitch 7/8" = 22,225 mm
- Mainly used in applications where inch pitch is an advantage (USA / UK)

- Width tolerance: ±1,0 [mm]
- Length tolerance: ±0,5 [mm/m]
- Thickness tolerance: ±0,4 [mm]

Technical Data

Belt width b Code / mm	Allowable tensile load Type M F _{Tzul} [N]	Allowable tensile load Type V F _{Tzul} [N]	Breaking load Type M F _{Br} [N]	Specific spring rate C _{spez} [N]	Weight [kg/m]
100 / 25,4	3920	1960	15200	980000	0,370
200 / 50,8	8330	4165	32300	2082500	0,660
300 / 76,2	12740	6370	49400	3185000	0,990
400 / 101,6	17150	8575	66500	4287500	1,330
600 / 152,4	25970	12985	100700	6492500	1,990

Other widths are available on request.

Load / Elongation [%]

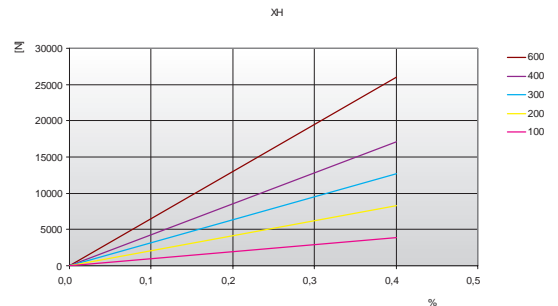

Tooth shear strength

rpm	F _{Uspez} [N/cm]	rpm	F _{Uspez} [N/cm]	rpm	F _{Uspez} [N/cm]	rpm	F _{Uspez} [N/cm]
0	96,00	800	55,99	1900	43,86	4000	33,31
20	92,98	900	54,35	2000	43,14	-	-
40	90,27	1000	52,88	2200	41,79	-	-
60	87,85	1100	51,55	2400	40,56	-	-
80	85,68	1200	50,33	2600	39,43	-	-
100	83,73	1300	49,20	2800	38,37	-	-
200	74,80	1400	48,16	2880	37,98	-	-
300	69,42	1440	47,77	3000	37,40	-	-
400	65,53	1500	47,19	3200	36,48	-	-
500	62,48	1600	46,29	3400	35,62	-	-
600	59,97	1700	45,43	3600	34,81	-	-
700	57,84	1800	44,62	3800	34,04	-	-

Tooth shear strength / rpm

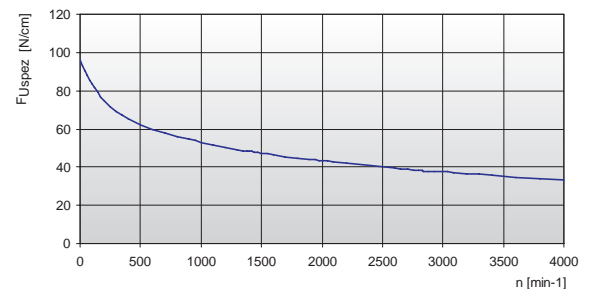

The specific load F_{Uspez} is the maximum load which one single belt tooth 1 cm wide can withstand in all operating conditions.

This force is related to the drive rpm.

The total load F_U transmissible by the belt in the drive is calculated by:



$$F_U [N] = F_{Uspez} \cdot Z_e \cdot b$$

- F_U [N] = peripheral force
- F_{Uspez} [N/cm] = specific load
- Z_e = number of teeth in mesh in the small pulley
- Z_{emax} = max. no of teeth in mesh to be considered for the calculation of the drive
- Z_{emax} = 12 for ELATECH® M
- Z_{emax} = 6 for ELATECH® V
- b [cm] = belt width in cm

Specialties

Belt width b Code / mm	ARAMID CORD		STAINLESS STEEL	
	F_{Tzul} [N] M type	F_{Br} [N]	F_{Tzul} [N] M type	F_{Br} [N]
100 / 25,4	3520	12640	2880	12000
200 / 50,8	7480	26860	6120	25500
300 / 76,2	11440	41080	-	-
400 / 101,6	15400	55300	-	-

Flexibility

Minimum pulley number of teeth and minimum idler diameter		Type of cord		
		STANDARD	ARAMID	STAINLESS
Drive without reverse bending 	Timing pulley z_{min}	18	18	24
	Flat idler running on belt teeth d_{min}	150 mm	150 mm	160 mm
Drive with reverse bending 	Timing pulley z_{min}	20	20	30
	Flat idler running on belt back d_{min}	180 mm	180 mm	200 mm

Timing pulleys

z	da	dw	z	da	dw	z	da	dw	z	da	dw
18	127,34	124,55	48	339,57	336,77	78	551,79	549,00	108	764,03	761,22
19	134,41	131,62	49	346,66	343,87	79	558,88	556,07	109	771,10	768,30
20	141,48	138,68	50	353,73	350,93	80	565,95	563,15	110	778,17	775,37
21	148,55	145,76	51	360,80	358,00	81	573,02	570,22	111	785,26	782,44
22	155,64	152,84	52	367,87	365,07	82	580,09	577,29	112	792,33	789,51
23	162,71	159,91	53	374,94	372,14	83	587,18	584,36	113	799,40	796,60
24	169,78	167,00	54	382,01	379,21	84	594,25	591,43	114	806,47	803,67
25	176,85	174,07	55	389,08	386,30	85	601,32	598,60	115	813,54	810,74
26	183,94	181,13	56	396,17	393,37	86	608,39	605,61	116	820,63	817,81
27	191,01	188,20	57	403,24	400,44	87	615,46	612,68	117	827,70	824,88
28	198,08	195,27	58	410,31	407,51	88	622,55	619,75	118	834,77	831,95
29	205,15	202,37	59	417,38	414,58	89	629,62	626,82	119	841,84	839,03
30	212,22	209,44	60	424,47	421,68	90	636,69	633,89	120	848,93	846,12
31	219,31	216,51	61	431,54	428,75	91	643,76	640,96			
32	226,38	223,58	62	438,61	435,90	92	650,85	648,04			
33	233,45	230,66	63	445,68	442,90	93	657,92	655,11			
34	240,52	237,73	64	452,75	449,97	94	664,99	662,18			
35	247,59	244,80	65	459,84	457,05	95	672,06	669,25			
36	254,68	251,87	66	466,91	464,10	96	679,13	676,33			
37	261,75	258,94	67	473,98	471,20	97	686,22	683,40			
38	268,82	266,02	68	481,05	478,25	98	693,29	690,47			
39	275,89	273,11	69	488,12	485,32	99	700,36	697,55			
40	282,98	280,18	70	495,21	492,39	100	707,43	704,62			
41	290,05	287,25	71	502,28	499,48	101	714,50	711,70			
42	297,12	294,33	72	509,35	506,57	102	721,59	718,77			
43	304,19	301,40	73	516,42	513,63	103	728,66	725,85			
44	311,26	308,47	74	523,51	520,70	104	735,73	732,92			
45	318,35	315,54	75	530,58	527,77	105	742,80	740,01			
46	325,42	322,61	76	537,65	534,84	106	749,87	747,08			
47	332,49	329,70	77	544,72	541,93	107	756,96	754,15			

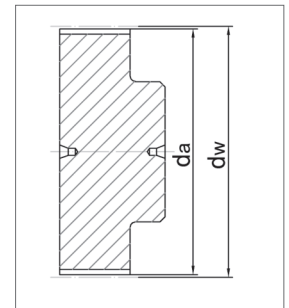

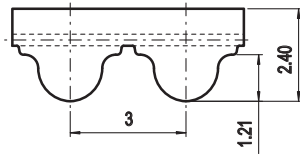

Belt characteristics

- Polyurethane timing belt with round tooth profile and high tensile load tension cords. Produced according to ISO 13050
- Metric pitch 3 mm
- The round tooth profile allows a uniform load distribution that guarantees high performances, high transmissible torque and precise tooth engagement
- Widely used in linear positioning, light power transmission applications

- Width tolerance: $\pm 0,5$ [mm]
- Length tolerance: $\pm 0,5$ [mm/m]
- Thickness tolerance: $\pm 0,2$ [mm]

Technical Data

Belt width b [mm]	Allowable tensile load Type M F_{Tzul} [N]	Allowable tensile load Type V F_{Tzul} [N]	Breaking load Type M F_{Br} [N]	Specific spring rate C_{spez} [N]	Weight [kg/m]
10	320	160	1250	80000	0,02
15	540	270	2125	135000	0,03
25	900	450	3500	225000	0,06
50	1860	930	7250	465000	0,12
100	3780	1890	14750	945000	0,24

Other widths are available on request.

Load / Elongation [%]

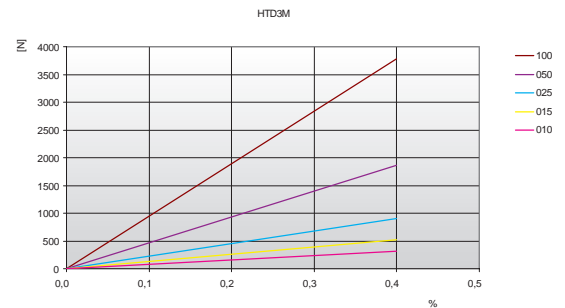

Tooth shear strength

rpm	F_{Uspez} [N/cm]	rpm	F_{Uspez} [N/cm]	rpm	F_{Uspez} [N/cm]	rpm	F_{Uspez} [N/cm]
0	25,20	800	17,30	1900	12,67	4500	7,05
20	24,60	900	16,75	2000	12,36	5000	6,32
40	24,06	1000	16,24	2200	11,77	5500	5,66
60	23,57	1100	15,75	2400	11,22	6000	5,04
80	23,12	1200	15,29	2600	10,71	6500	4,47
100	22,72	1300	14,86	2800	10,24	7000	3,94
200	21,22	1400	14,45	3000	9,79	7500	3,44
300	20,31	1440	14,29	3200	9,36	8000	2,98
400	19,75	1500	14,06	3400	8,96	8500	2,54
500	19,14	1600	13,69	3600	8,57	9000	2,12
600	18,50	1700	13,33	3800	8,21	9500	1,72
700	17,88	1800	12,99	4000	7,86	10000	1,35

Tooth shear strength / rpm

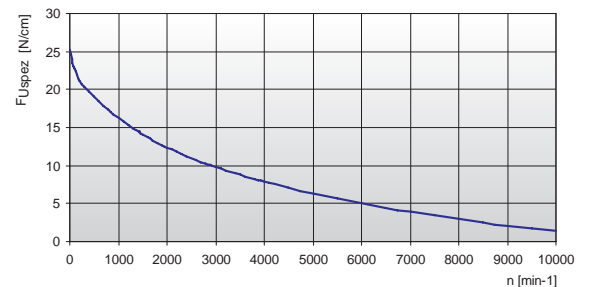

The specific load F_{Uspez} is the maximum load which one single belt tooth 1 cm wide can withstand in all operating conditions.

This force is related to the drive rpm.

The total load F_u transmissible by the belt in the drive is calculated by:

$$F_u [N] = F_{Uspez} \cdot Z_e \cdot b$$

- F_u [N] = peripheral force
- F_{Uspez} [N/cm] = specific load
- Z_e = number of teeth in mesh in the small pulley
- Z_{emax} = max. no of teeth in mesh to be considered for the calculation of the drive
- Z_{emax} = 12 for ELATECH® M
- Z_{emax} = 6 for ELATECH® V
- b [cm] = belt width in cm

Flexibility

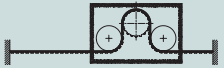
Minimum pulley number of teeth and minimum idler diameter		Type of cord
		STANDARD
Drive without reverse bending 	Timing pulley Z_{min}	20
	Flat idler running on belt teeth d_{min}	30 mm
Drive with reverse bending 	Timing pulley Z_{min}	20
	Flat idler running on belt back d_{min}	30 mm

Timing pulleys

Z	da	dw	Z	da	dw	Z	da	dw	Z	da	dw
10	8,79	9,55	44	41,26	42,02	78	73,73	74,49	112	106,2	106,96
11	9,74	10,50	45	42,21	42,97	79	74,68	75,44	113	107,15	107,91
12	10,70	11,46	46	43,17	43,93	80	75,64	76,40	114	108,11	108,87
13	11,65	12,41	47	44,12	44,88	81	76,59	77,35	115	109,06	109,82
14	12,61	13,37	48	45,08	45,84	82	77,55	78,31	116	110,02	110,78
15	13,56	14,32	49	46,03	46,79	83	78,50	79,26	117	110,97	111,73
16	14,52	15,28	50	46,99	47,75	84	79,46	80,22	118	111,93	112,69
17	15,47	16,23	51	47,94	48,70	85	80,41	81,17	119	112,88	113,64
18	16,43	17,19	52	48,90	49,66	86	81,37	82,13	120	113,83	114,59
19	17,38	18,14	53	49,85	50,61	87	82,32	83,08	121	114,79	115,55
20	18,34	19,10	54	50,81	51,57	88	83,28	84,04	122	115,74	116,50
21	19,29	20,05	55	51,76	52,52	89	84,23	84,99	123	116,70	117,46
22	20,25	21,01	56	52,72	53,48	90	85,19	85,95	124	117,65	118,41
23	21,20	21,96	57	53,67	54,43	91	86,14	86,90	125	118,61	119,37
24	22,16	22,92	58	54,63	55,39	92	87,10	87,86	126	119,56	120,32
25	23,11	23,87	59	55,58	56,34	93	88,05	88,81	127	120,52	121,28
26	24,07	24,83	60	56,54	57,30	94	89,01	89,77	128	121,47	122,23
27	25,02	25,78	61	57,49	58,25	95	89,96	90,72	129	122,43	123,19
28	25,98	26,74	62	58,45	59,21	96	90,92	91,68	130	123,38	124,14
29	26,93	27,69	63	59,40	60,16	97	91,87	92,63	131	124,34	125,10
30	27,89	28,65	64	60,36	61,12	98	92,83	93,59	132	125,29	126,05
31	28,84	29,60	65	61,31	62,07	99	93,78	94,54	133	126,25	127,01
32	29,80	30,56	66	62,27	63,03	100	94,74	95,50	134	127,20	127,96
33	30,75	31,51	67	63,22	63,98	101	95,69	96,45	135	128,16	128,92
34	31,71	32,47	68	64,18	64,94	102	96,65	97,41	136	129,11	129,87
35	32,66	33,42	69	65,13	65,89	103	97,60	98,36	137	130,07	130,83
36	33,62	34,38	70	66,09	66,85	104	98,56	99,32	138	131,02	131,78
37	34,57	35,33	71	67,04	67,80	105	99,51	100,27	139	131,98	132,74
38	35,53	36,29	72	68,00	68,76	106	100,47	101,23	140	132,93	133,69
39	36,48	37,24	73	68,95	69,71	107	101,42	102,18			
40	37,44	38,20	74	69,91	70,67	108	102,38	103,14			
41	38,39	39,15	75	70,86	71,62	109	103,33	104,09			
42	39,35	40,11	76	71,82	72,58	110	104,29	105,05			
43	40,30	41,06	77	72,77	73,53	111	105,24	106,00			

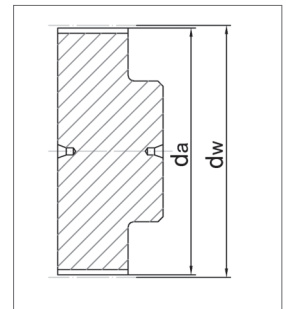

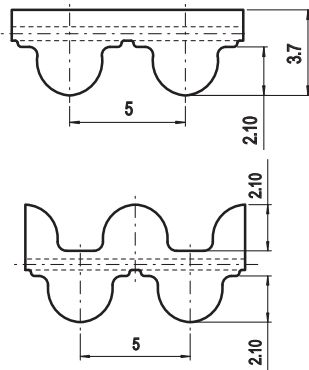

Belt characteristics

- Polyurethane timing belt with round tooth profile and high tensile load tension cords. Produced according to ISO 13050
- Metric pitch 5 mm
- The round tooth profile allows a uniform load distribution that guarantees high performances, high transmissible torque and precise tooth engagement
- Widely used in linear positioning, light power transmission applications
- Double sided tooth construction available

- Width tolerance: $\pm 0,5$ [mm]
- Length tolerance: $\pm 0,5$ [mm/m]
- Thickness tolerance: $\pm 0,2$ [mm]

Technical Data

Belt width b [mm]	Allowable tensile load Type M F_{Tzul} [N]	Allowable tensile load Type V F_{Tzul} [N]	Breaking load Type M F_{Br} [N]	Specific spring rate C_{spez} [N]	Weight [kg/m]
10	920	460	3360	230000	0,050
15	1500	750	5460	375000	0,070
25	2650	1325	9660	662500	0,120
50	5520	2760	20160	1380000	0,240
100	11270	5635	41160	2817500	0,480

Other widths are available on request.

Load / Elongation [%]

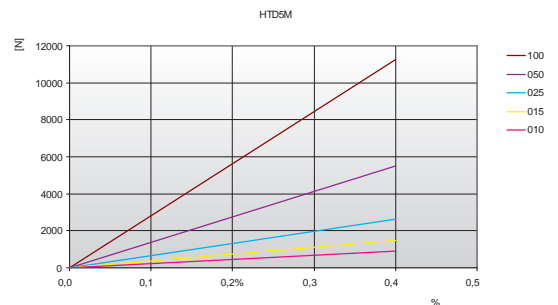

Tooth shear strength

rpm	F_{Uspez} [N/cm]	rpm	F_{Uspez} [N/cm]	rpm	F_{Uspez} [N/cm]	rpm	F_{Uspez} [N/cm]
0	36,80	800	27,21	1900	22,24	4500	16,40
20	36,25	900	26,61	2000	21,91	5000	15,64
40	35,75	1000	26,05	2200	21,30	5500	14,95
60	35,30	1100	25,52	2400	20,72	6000	14,32
80	34,89	1200	25,03	2600	20,19	6500	13,74
100	34,52	1300	24,56	2800	19,69	7000	13,19
200	33,13	1400	24,13	3000	19,23	7500	12,68
300	30,87	1440	23,96	3200	18,78	8000	12,20
400	30,10	1500	23,71	3400	18,37	8500	11,75
500	29,31	1600	23,32	3600	17,97	9000	11,33
600	28,56	1700	22,94	3800	17,59	9500	10,92
700	27,86	1800	22,58	4000	17,23	10000	10,53

Tooth shear strength / rpm

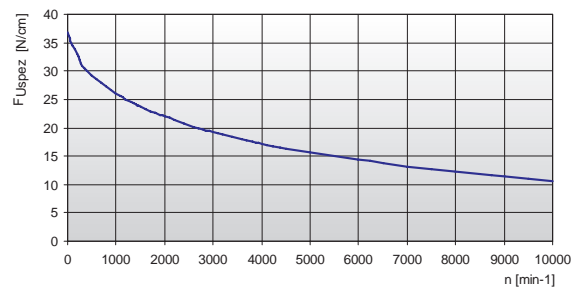

The specific load F_{Uspez} is the maximum load which one single belt tooth 1 cm wide can withstand in all operating conditions. This force is related to the drive rpm.

The total load F_U transmissible by the belt in the drive is calculated by:



$$F_U [N] = F_{Uspez} \cdot Z_e \cdot b$$

- $F_U [N]$ = peripheral force
- $F_{Uspez} [N/cm]$ = specific load
- Z_e = number of teeth in mesh in the small pulley
- Z_{emax} = max. no of teeth in mesh to be considered for the calculation of the drive
- Z_{emax} = 12 for ELATECH® M
- Z_{emax} = 6 for ELATECH® V
- $b [cm]$ = belt width in cm

Specialties

Belt width b [mm]	ARAMID CORD		STAINLESS STEEL	
	F_{Tzul} [N] M type	F_{Br} [N]	F_{Tzul} [N] M type	F_{Br} [N]
10	880	3600	600	2400
15	1430	5850	980	3900
25	2530	10350	1730	6900
50	5280	21600	3600	14400

Flexibility

Minimum pulley number of teeth and minimum idler diameter		Type of cord		
		STANDARD	ARAMID	STAINLESS
Drive without reverse bending 	Timing pulley z_{min}	16	16	18
	Flat idler running on belt teeth d_{min}	30 mm	30 mm	40 mm
Drive with reverse bending 	Timing pulley z_{min}	25	25	25
	Flat idler running on belt back d_{min}	60 mm	60 mm	65 mm

Timing pulleys

z	da	dw	z	da	dw	z	da	dw	z	da	dw
10	14,77	15,91	40	62,52	63,66	70	110,27	111,41	100	158,01	159,15
11	16,36	17,50	41	64,11	65,25	71	111,86	113,00	101	159,61	160,75
12	17,96	19,10	42	65,70	66,84	72	113,45	114,59	102	161,2	162,34
13	19,55	20,69	43	67,29	68,43	73	115,04	116,18	103	162,81	163,95
14	21,14	22,28	44	68,88	70,02	74	116,63	117,77	104	164,38	165,52
15	22,73	23,87	45	70,47	71,61	75	118,22	119,36	105	165,97	167,11
16	24,32	25,46	46	72,06	73,20	76	119,81	120,95	106	167,56	168,70
17	25,91	27,05	47	73,65	74,79	77	121,40	122,54	107	169,09	170,23
18	27,51	28,65	48	75,24	76,38	78	122,99	124,13	108	170,75	171,89
19	29,09	30,23	49	76,84	77,98	79	124,58	125,72	109	172,34	173,48
20	30,69	31,83	50	78,44	79,58	80	126,18	127,32	110	173,93	175,07
21	32,28	33,42	51	80,03	81,17	81	127,77	128,91	111	175,52	176,66
22	33,87	35,01	52	81,62	82,76	82	129,36	130,50	112	177,11	178,25
23	35,46	36,60	53	83,21	84,35	83	130,95	132,09	113	178,70	179,84
24	37,06	38,20	54	84,80	85,94	84	132,54	133,68	114	180,29	181,43
25	38,64	39,78	55	86,39	87,53	85	134,14	135,28	115	181,88	183,02
26	40,24	41,38	56	87,98	89,12	86	135,73	136,87	116	183,47	184,61
27	41,83	42,97	57	89,57	90,71	87	137,32	138,46	117	185,07	186,21
28	43,42	44,56	58	91,17	92,31	88	138,91	140,05	118	186,66	187,80
29	45,01	46,15	59	92,76	93,90	89	140,51	141,65	119	188,25	189,39
30	46,61	47,75	60	94,35	95,49	90	142,10	143,24	120	189,84	190,98
31	48,19	49,33	61	95,94	97,08	91	143,69	144,83			
32	49,79	50,93	62	97,53	98,67	92	145,28	146,42			
33	51,38	52,52	63	99,12	100,26	93	146,87	148,01			
34	52,97	54,11	64	100,72	101,86	94	148,46	149,60			
35	54,56	55,70	65	102,31	103,45	95	150,06	151,20			
36	56,16	57,30	66	103,90	105,04	96	151,64	152,78			
37	57,75	58,89	67	105,49	106,63	97	153,24	154,38			
38	59,34	60,48	68	107,08	108,22	98	154,83	155,97			
39	60,93	62,07	69	108,67	109,81	99	156,42	157,56			

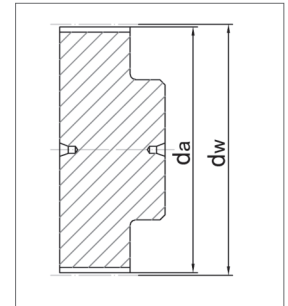

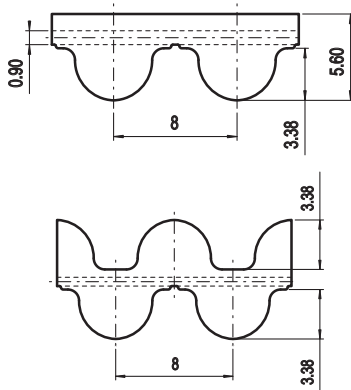

Belt characteristics

- Polyurethane timing belt with round tooth profile and high tensile load tension cords. Produced according to ISO 13050
- Metric pitch 8 mm
- The round tooth profile allows a uniform load distribution that guarantees high performances, high transmissible torque and precise tooth engagement
- Widely used in linear positioning, medium power transmission applications
- Double sided tooth construction available

- Width tolerance: $\pm 0,5$ [mm]
- Length tolerance: $\pm 0,5$ [mm/m]
- Thickness tolerance: $\pm 0,2$ [mm]

Technical Data

Belt width b [mm]	Allowable tensile load Type M F_{Tzul} [N]	Allowable tensile load Type V F_{Tzul} [N]	Breaking load Type M F_{Br} [N]	Specific spring rate C_{spez} [N]	Weight [kg/m]
10	1470	735	5700	367500	0,07
15	2210	1105	8550	552500	0,10
20	3190	1595	12350	797500	0,14
30	4660	2330	18050	1165000	0,21
50	8580	4290	33250	2145000	0,35
85	14700	7350	57000	3675000	0,59
100	17400	8700	67450	4350000	0,69

Other widths are available on request.

Load / Elongation [%]

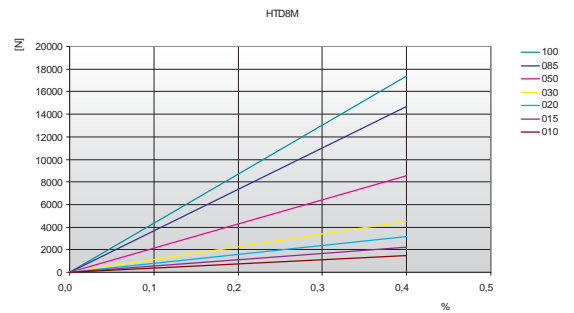

Tooth shear strength

rpm	F_{Uspez} [N/cm]	rpm	F_{Uspez} [N/cm]	rpm	F_{Uspez} [N/cm]	rpm	F_{Uspez} [N/cm]
0	74,00	800	51,20	1900	39,52	4500	26,63
20	72,62	900	49,71	2000	38,78	5000	25,00
40	71,34	1000	48,35	2200	37,39	5500	23,51
60	70,16	1100	47,09	2400	36,12	6000	22,15
80	69,07	1200	45,93	2600	34,94	-	-
100	68,07	1300	44,84	2800	33,83	-	-
200	64,09	1400	43,82	3000	32,80	-	-
300	61,68	1440	43,43	3200	31,83	-	-
400	59,03	1500	42,86	3400	30,91	-	-
500	56,71	1600	41,96	3600	30,05	-	-
600	54,66	1700	41,10	3800	29,22	-	-
700	52,84	1800	40,29	4000	28,44	-	-

Tooth shear strength / rpm

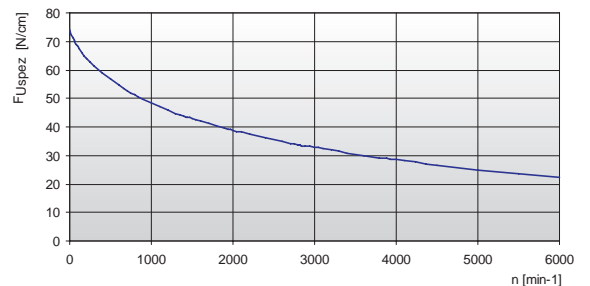

The specific load F_{Uspez} is the maximum load which one single belt tooth 1 cm wide can withstand in all operating conditions. This force is related to the drive rpm. The total load F_u transmissible by the belt in the drive is calculated by:



$$F_u [N] = F_{Uspez} \cdot Z_e \cdot b$$

- F_u [N] = peripheral force
- F_{Uspez} [N/cm] = specific load
- Z_e = number of teeth in mesh in the small pulley
- Z_{emax} = max. no of teeth in mesh to be considered for the calculation of the drive
- Z_{emax} = 12 for ELATECH® M
- Z_{emax} = 6 for ELATECH® V
- b [cm] = belt width in cm

Specialties

Belt width b [mm]	ARAMID CORD		STAINLESS STEEL		HPL High Performance	
	F_{Tzul} [N] M type	F_{Br} [N]	F_{Tzul} [N] M type	F_{Br} [N]	F_{Tzul} [N] M type	F_{Br} [N]
10	1140	4740	1080	4500	-	-
15	1710	7110	1620	6750	-	-
20	2470	10270	2340	9750	5280	19250
30	3800	15800	3600	15000	8640	31500
50	6650	27650	6300	26250	14400	52500
85	11400	47400	-	-	25440	92750
100	13500	56000	-	-	29280	106750

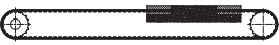
Flexibility

Minimum pulley number of teeth and minimum idler diameter		Type of cord			
		STANDARD	ARAMID	STAINLESS	HPL
Drive without reverse bending 	Timing pulley z_{min}	18	18	24	30
	Flat idler running on belt teeth d_{min}	50 mm	50 mm	70 mm	80 mm
Drive with reverse bending 	Timing pulley z_{min}	30	30	40	30
	Flat idler running on belt back d_{min}	120 mm	120 mm	100 mm	150 mm

Timing pulleys

z	da	dw	z	da	dw	z	da	dw	z	da	dw
18	44,46	45,83	48	120,86	122,23	78	197,25	198,62	108	273,64	275,01
19	47,01	48,38	49	123,40	124,77	79	199,80	201,17	109	276,19	277,56
20	49,56	50,93	50	125,95	127,32	80	202,35	203,72	110	278,74	280,11
21	52,10	53,47	51	128,50	129,87	81	204,89	206,26	111	281,29	282,66
22	54,65	56,02	52	131,05	132,41	82	207,44	208,81	112	283,84	285,21
23	57,20	58,57	53	133,59	134,96	83	209,98	211,35	113	286,38	287,75
24	59,75	61,12	54	136,14	137,51	84	212,53	213,90	114	288,93	290,30
25	62,29	63,66	55	138,68	140,05	85	215,08	216,45	115	291,47	292,84
26	64,84	66,21	56	141,23	142,60	86	217,63	219,00	116	294,02	295,39
27	67,38	68,75	57	143,78	145,15	87	220,17	221,54	117	296,57	297,94
28	70,08	71,30	58	146,32	147,69	88	222,72	224,09	118	299,11	300,48
29	72,59	73,84	59	148,87	150,24	89	225,26	226,63	119	301,66	303,03
30	75,13	76,39	60	151,42	152,79	90	227,81	229,18	120	304,20	305,57
31	77,65	78,94	61	153,96	155,33	91	230,35	231,72			
32	80,16	81,49	62	156,52	157,89	92	232,90	234,27			
33	82,68	84,03	63	159,06	160,43	93	235,45	236,82			
34	85,21	86,58	64	161,60	162,97	94	238,00	239,37			
35	87,76	89,12	65	164,15	165,52	95	240,54	241,91			
36	90,30	91,67	66	166,69	168,06	96	243,09	244,46			
37	92,85	94,22	67	169,24	170,61	97	245,63	247,00			
38	95,40	96,77	68	171,79	173,16	98	248,18	249,55			
39	97,94	99,31	69	174,33	175,70	99	250,73	252,10			
40	100,49	101,86	70	176,88	178,25	100	253,28	254,67			
41	103,04	104,40	71	179,43	180,80	101	255,82	257,19			
42	105,58	106,95	72	181,98	183,35	102	258,37	259,74			
43	108,13	109,50	73	184,52	185,89	103	260,91	262,28			
44	110,68	112,05	74	187,07	188,44	104	263,46	264,83			
45	113,22	114,59	75	189,61	190,98	105	266,01	267,38			
46	115,77	117,14	76	192,16	193,53	106	268,55	269,92			
47	118,31	119,68	77	194,71	196,08	107	271,10	272,47			

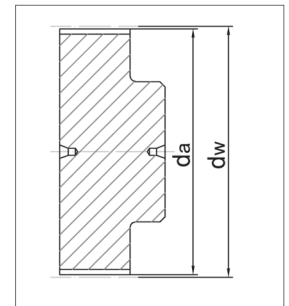

HTD 14M

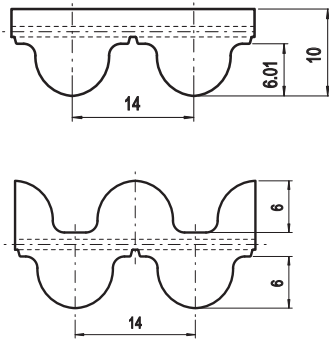

Belt characteristics

- Polyurethane timing belt with round tooth profile and high tensile load tension cords. Produced according to ISO 13050
- Metric pitch 14 mm
- The round tooth profile, allows a uniform load distribution that guarantees high performances high transmissible torque and precise tooth engagement
- Widely used in linear positioning, heavy power transmission applications
- Double sided tooth construction available

- Width tolerance: $\pm 1,0$ [mm]
- Length tolerance: $\pm 0,5$ [mm/m]
- Thickness tolerance: $\pm 0,4$ [mm]

Technical Data

Belt width b [mm]	Allowable tensile load Type M F_{Tzul} [N]	Allowable tensile load Type V F_{Tzul} [N]	Breaking load Type M F_{Br} [N]	Specific spring rate C_{spez} [N]	Weight [kg/m]
25	5280	2640	19250	1320000	0,28
40	9120	4560	33250	2280000	0,44
55	12480	6240	45500	3120000	0,61
85	19680	9840	71750	4920000	0,94
115	26880	13440	98000	6720000	1,25
150	35520	17760	129500	8880000	1,68

Load / Elongation [%]

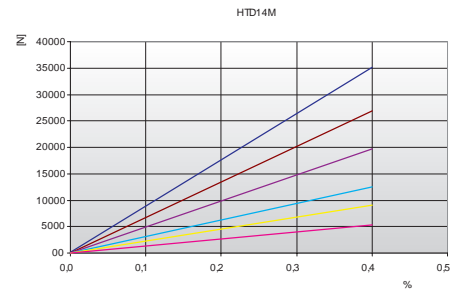

Other widths are available on request.

Tooth shear strength

rpm	F_{Uspez} [N/cm]	rpm	F_{Uspez} [N/cm]	rpm	F_{Uspez} [N/cm]
0	130,00	800	83,80	1900	60,49
20	127,69	900	80,85	2000	59,01
40	125,56	1000	78,14	2200	56,23
60	123,60	1100	75,63	2400	53,68
80	121,78	1200	73,31	2600	51,30
100	120,11	1300	71,14	2800	49,09
200	109,77	1400	69,11	3000	47,01
300	104,29	1440	68,33	3200	45,06
400	99,19	1500	67,19	3400	43,22
500	94,65	1600	65,38	3600	41,48
600	90,64	1700	63,67	3800	39,82
700	87,04	1800	62,04	4000	38,24

Tooth shear strength / rpm

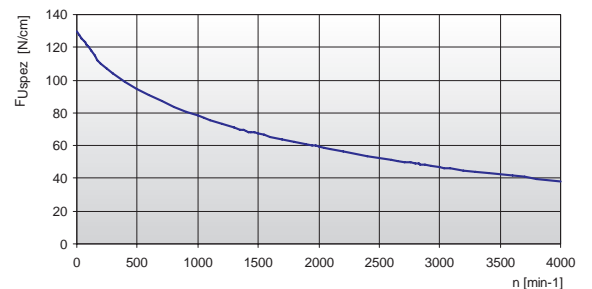

The specific load F_{Uspez} is the maximum load which one single belt tooth 1 cm wide can withstand in all operating conditions. This force is related to the drive rpm. The total load F_u transmissible by the belt in the drive is calculated by:

$$F_u [N] = F_{Uspez} \cdot Z_e \cdot b$$

- $F_u [N]$ = peripheral force
- $F_{Uspez} [N/cm]$ = specific load
- Z_e = number of teeth in mesh in the small pulley
- Z_{emax} = max. no of teeth in mesh to be considered for the calculation of the drive
- Z_{emax} = 12 for ELATECH® M
- Z_{emax} = 6 for ELATECH® V
- $b [cm]$ = belt width in cm

Flexibility

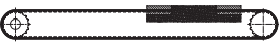
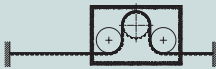
Minimum pulley number of teeth and minimum idler diameter		Type of cord
		STANDARD
Drive without reverse bending 	Timing pulley z_{min}	28
	Flat idler running on belt teeth d_{min}	120 mm
Drive with reverse bending 	Timing pulley z_{min}	28
	Flat idler running on belt back d_{min}	180 mm

Timing pulleys

z	da	dw
28	122,12	124,77
29	126,58	129,22
30	130,99	133,69
31	135,45	138,14
32	139,88	142,59
33	144,35	147,06
34	148,79	151,51
35	153,25	155,96
36	157,68	160,41
37	162,14	164,88
38	166,60	169,34
39	171,02	173,79
40	175,48	178,24
41	179,92	182,71
42	184,37	187,16
43	188,83	191,61
44	193,29	196,08
45	197,75	200,53
46	202,21	204,98
47	206,65	209,43
48	211,11	213,90
49	215,57	218,35
50	220,03	222,80
51	224,49	227,27
52	228,95	231,72
53	233,39	236,18
54	237,85	240,64
55	242,30	245,09
56	246,76	249,55
57	251,22	254,01

z	da	dw
58	255,68	258,46
59	260,14	262,91
60	264,60	267,38
61	269,04	271,83
62	273,50	276,28
63	277,96	280,75
64	282,42	285,20
65	286,88	289,65
66	291,32	294,11
67	295,78	298,56
68	300,24	303,03
69	304,70	307,48
70	309,16	311,93
71	313,61	316,40
72	318,07	320,85
73	322,53	325,30
74	326,98	329,77
75	331,44	334,22
76	335,90	338,67
77	340,34	343,12
78	344,80	347,59
79	349,26	352,04
80	353,72	356,49
81	358,17	360,96
82	362,63	365,41
83	367,09	369,86
84	371,54	374,33
85	376,00	378,78
86	380,46	383,23
87	384,91	387,70

z	da	dw
88	389,37	392,15
89	393,83	396,60
90	398,29	401,07
91	402,73	405,52
92	407,19	409,97
93	411,65	414,44
94	416,10	418,89
95	420,56	423,35
96	425,02	427,80
97	429,48	432,25
98	433,94	436,72
99	438,38	441,17
100	442,84	445,62
101	447,30	450,09
102	451,76	454,54
103	456,21	459,00
104	460,67	463,45
105	465,13	467,90
106	469,58	472,37
107	474,03	476,82
108	478,49	481,28
109	482,95	485,74
110	487,41	490,19
111	491,87	494,64
112	496,32	499,10
113	500,78	503,55
114	505,23	508,02
116	514,14	516,93
117	518,60	521,38
118	523,06	525,83

z	da	dw
119	527,51	530,30
120	531,97	534,75

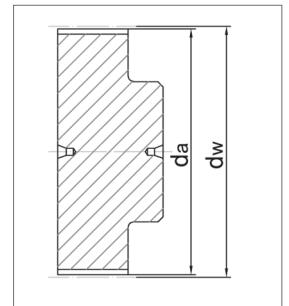

HTD 14M XHPL

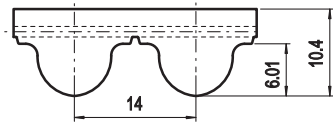

Belt characteristics

- Polyurethane timing belt with round tooth profile and high tensile load tension cords. Produced according to ISO 13050
- Metric pitch 14 mm
- The round tooth profile, allows a uniform load distribution that guarantees high performances high transmissible torque and precise tooth engagement
- **HTD14M - XHPL is the ideal belt for heavy duty synchronous lifting applications**
- **Black color and PAZ fabric as standard for XHPL execution**

- Width tolerance: $\pm 1,0$ [mm]
- Length tolerance: $\pm 0,5$ [mm/m]
- Thickness tolerance: $\pm 0,5$ [mm]

Technical Data - HTD14M XHPL

Belt width b [mm]	Allowable tensile load Type M F_{Tzul} [N]	Breaking load Type M F_{Br} [N]	Specific spring rate C_{spez} [N]	Weight [kg/m]
40	22000	77000	5500000	0,59
55	32000	112000	8000000	0,75
85	50000	175000	12500000	1,29
115	68000	238000	17000000	1,75
150	90000	315000	22500000	2,21

Other widths are available on request.

Load / Elongation [%]

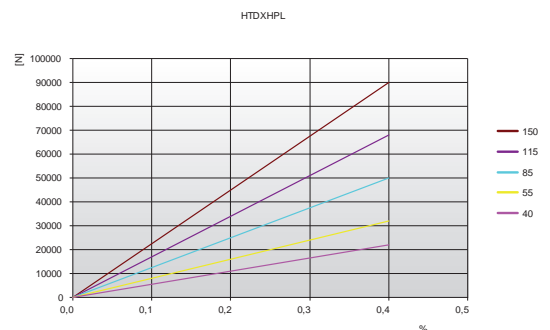

Tooth shear strength

rpm	F_{Uspez} [N/cm]	rpm	F_{Uspez} [N/cm]	rpm	F_{Uspez} [N/cm]
0	130,00	800	83,80	1900	60,49
20	127,69	900	80,85	2000	59,01
40	125,56	1000	78,14	2200	56,23
60	123,60	1100	75,63	2400	53,68
80	121,78	1200	73,31	2600	51,30
100	120,11	1300	71,14	2800	49,09
200	109,77	1400	69,11	3000	47,01
300	104,29	1440	68,33	3200	45,06
400	99,19	1500	67,19	3400	43,22
500	94,65	1600	65,38	3600	41,48
600	90,64	1700	63,67	3800	39,82
700	87,04	1800	62,04	4000	38,24

Tooth shear strength / rpm

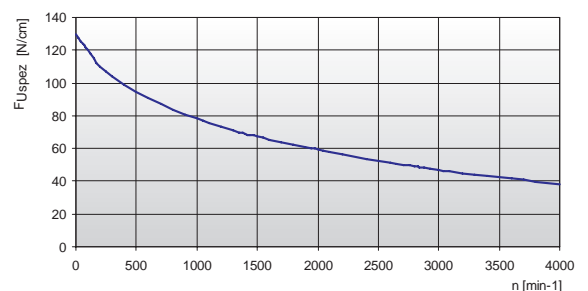



The specific load F_{Uspez} is the maximum load which one single belt tooth 1 cm wide can withstand in all operating conditions. This force is related to the drive rpm. The total load F_u transmissible by the belt in the drive is calculated by:

$$F_u [N] = F_{Uspez} \cdot z_e \cdot b$$

- F_u [N] = peripheral force
- F_{Uspez} [N/cm] = specific load
- z_e = number of teeth in mesh in the small pulley
- z_{emax} = max. no of teeth in mesh to be considered for the calculation of the drive
- z_{emax} = 12 for ELATECH® M
- z_{emax} = 6 for ELATECH® V
- b [cm] = belt width in cm

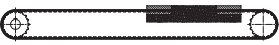
Flexibility

Minimum pulley number of teeth and minimum idler diameter		Type of cord
		STANDARD
Drive without reverse bending 	Timing pulley z_{min}	34
	Flat idler running on belt teeth d_{min}	140 mm
Drive with reverse bending 	Timing pulley z_{min}	34
	Flat idler running on belt back d_{min}	200 mm

Timing pulleys

z	da	dw
28	122,12	124,77
29	126,58	129,22
30	130,99	133,69
31	135,45	138,14
32	139,88	142,59
33	144,35	147,06
34	148,79	151,51
35	153,25	155,96
36	157,68	160,41
37	162,14	164,88
38	166,60	169,34
39	171,02	173,79
40	175,48	178,24
41	179,92	182,71
42	184,37	187,16
43	188,83	191,61
44	193,29	196,08
45	197,75	200,53
46	202,21	204,98
47	206,65	209,43
48	211,11	213,90
49	215,57	218,35
50	220,03	222,80
51	224,49	227,27
52	228,95	231,72
53	233,39	236,18
54	237,85	240,64
55	242,30	245,09
56	246,76	249,55
57	251,22	254,01

z	da	dw
58	255,68	258,46
59	260,14	262,91
60	264,60	267,38
61	269,04	271,83
62	273,50	276,28
63	277,96	280,75
64	282,42	285,20
65	286,88	289,65
66	291,32	294,11
67	295,78	298,56
68	300,24	303,03
69	304,70	307,48
70	309,16	311,93
71	313,61	316,40
72	318,07	320,85
73	322,53	325,30
74	326,98	329,77
75	331,44	334,22
76	335,90	338,67
77	340,34	343,12
78	344,80	347,59
79	349,26	352,04
80	353,72	356,49
81	358,17	360,96
82	362,63	365,41
83	367,09	369,86
84	371,54	374,33
85	376,00	378,78
86	380,46	383,23
87	384,91	387,70

z	da	dw
88	389,37	392,15
89	393,83	396,60
90	398,29	401,07
91	402,73	405,52
92	407,19	409,97
93	411,65	414,44
94	416,10	418,89
95	420,56	423,35
96	425,02	427,80
97	429,48	432,25
98	433,94	436,72
99	438,38	441,17
100	442,84	445,62
101	447,30	450,09
102	451,76	454,54
103	456,21	459,00
104	460,67	463,45
105	465,13	467,90
106	469,58	472,37
107	474,03	476,82
108	478,49	481,28
109	482,95	485,74
110	487,41	490,19
111	491,87	494,64
112	496,32	499,10
113	500,78	503,55
114	505,23	508,02
116	514,14	516,93
117	518,60	521,38
118	523,06	525,83

z	da	dw
119	527,51	530,30
120	531,97	534,75

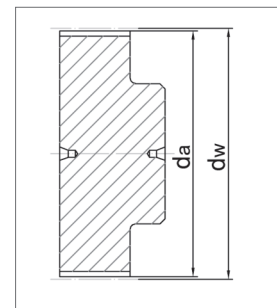

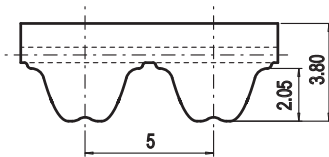

Belt characteristics

- Polyurethane timing belt with round tooth profile and high tensile load tension cords. Produced according to ISO 13050
- Metric pitch 5 mm
- The tooth profile allows a uniform load distribution that guarantees high performances, high transmissible torque and precise tooth engagement
- PAZ fabric on tooth side delivered as standard reduces noise in the drive
- Widely used in linear positioning, light power transmission applications

- Width tolerance: $\pm 0,5$ [mm]
- Length tolerance: $\pm 0,5$ [mm/m]
- Thickness tolerance: $\pm 0,2$ [mm]

Technical Data

Belt width b [mm]	Allowable tensile load Type M F_{Tzul} [N]	Allowable tensile load Type V F_{Tzul} [N]	Breaking load Type M F_{Br} [N]	Specific spring rate C_{spez} [N]	Weight [kg/m]
10	920	460	3360	230000	0,05
15	1500	750	5460	375000	0,07
25	2650	1325	9660	662500	0,12
30	3220	1610	11760	805000	0,15
50	5520	2760	20160	1380000	0,23
100	11270	5635	41160	2817500	0,46

Other widths are available on request.

Load / Elongation [%]

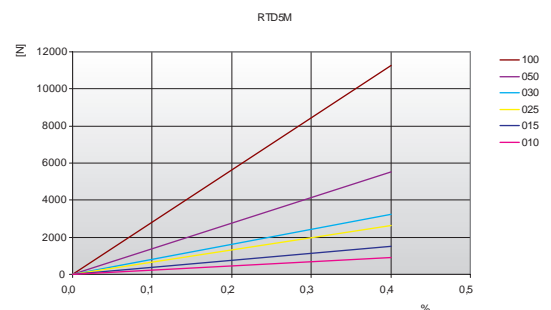

Tooth shear strength

rpm	F_{Uspez} [N/cm]	rpm	F_{Uspez} [N/cm]	rpm	F_{Uspez} [N/cm]	rpm	F_{Uspez} [N/cm]
0	37,80	900	28,61	2200	23,30	5500	16,95
20	37,25	1000	28,05	2400	22,72	6000	16,32
40	36,75	1100	27,52	2600	22,19	6500	15,74
60	36,30	1200	27,03	2800	21,69	7000	15,19
80	35,89	1300	26,56	2880	21,50	7500	14,68
100	35,52	1400	26,13	3000	21,23	8000	14,20
200	34,13	1440	25,96	3200	20,78	8500	13,75
300	32,87	1500	25,71	3400	20,37	9000	13,33
400	32,10	1600	25,32	3600	19,97	9500	12,92
500	31,31	1700	24,94	3800	19,59	10000	12,53
600	30,56	1800	24,58	4000	19,23		
700	29,86	1900	24,24	4500	18,40		
800	29,21	2000	23,91	5000	17,64		

Tooth shear strength / rpm

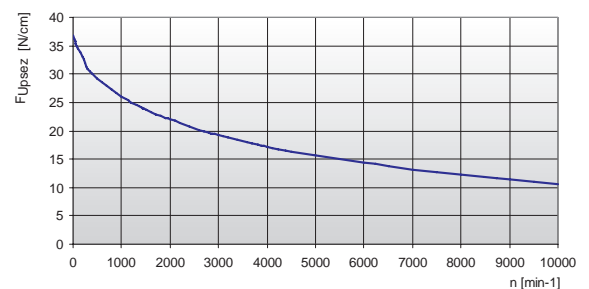

The specific load F_{Uspez} is the maximum load which one single belt tooth 1 cm wide can withstand in all operating conditions. This force is related to the drive rpm. The total load F_U transmissible by the belt in the drive is calculated by:



$$F_U [N] = F_{Uspez} \cdot Z_e \cdot b$$

- $F_U [N]$ = peripheral force
- $F_{Uspez} [N/cm]$ = specific load
- Z_e = number of teeth in mesh in the small pulley
- Z_{emax} = max. no of teeth in mesh to be considered for the calculation of the drive
- Z_{emax} = 12 for ELATECH® M
- Z_{emax} = 6 for ELATECH® V
- $b [cm]$ = belt width in cm

Specialties

Belt width b [mm]	ARAMID CORD		STAINLESS STEEL		HFE High Flexibility	
	F _{Tzul} [N] M type	F _{Br} [N]	F _{Tzul} [N] M type	F _{Br} [N]	F _{Tzul} [N] M type	F _{Br} [N]
10	880	3600	600	2400	960	3440
15	1430	5850	1730	3900	1560	5590
25	2530	10350	2100	6900	2760	9890
30	3080	12600	2100	8400	3360	12040
50	5280	21600	3600	14400	5760	20640
100	10780	44100	-	-	-	-

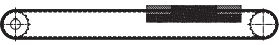
Flexibility

Minimum pulley number of teeth and minimum idler diameter		Type of cord			
		STANDARD	ARAMID	STAINLESS	HFE
Drive without reverse bending 	Timing pulley z _{min}	16	16	18	15
	Flat idler running on belt teeth d _{min}	30 mm	30 mm	40 mm	25 mm
Drive with reverse bending 	Timing pulley z _{min}	25	25	25	20
	Flat idler running on belt back d _{min}	60 mm	60 mm	65 mm	60 mm

Timing pulleys

z	da	dw	z	da	dw	z	da	dw	z	da	dw
10	14,77	15,91	40	62,52	63,66	70	110,27	111,41	100	158,01	159,15
11	16,36	17,50	41	64,11	65,25	71	111,86	113,00	101	159,61	160,75
12	17,96	19,10	42	65,70	66,84	72	113,45	114,59	102	161,20	162,34
13	19,55	20,69	43	67,29	68,43	73	115,04	116,18	103	162,81	163,95
14	21,14	22,28	44	68,88	70,02	74	116,63	117,77	104	164,38	165,52
15	22,73	23,87	45	70,47	71,61	75	118,22	119,36	105	165,97	167,11
16	24,32	25,46	46	72,06	73,20	76	119,81	120,95	106	167,56	168,70
17	25,91	27,05	47	73,65	74,79	77	121,40	122,54	107	169,09	170,23
18	27,51	28,65	48	75,24	76,38	78	122,99	124,13	108	170,75	171,89
19	29,09	30,23	49	76,84	77,98	79	124,58	125,72	109	172,34	173,48
20	30,69	31,83	50	78,44	79,58	80	126,18	127,32	110	173,93	175,07
21	32,28	33,42	51	80,03	81,17	81	127,77	128,91	111	175,52	176,66
22	33,87	35,01	52	81,62	82,76	82	129,36	130,50	112	177,11	178,25
23	35,46	36,60	53	83,21	84,35	83	130,95	132,09	113	178,70	179,84
24	37,06	38,20	54	84,80	85,94	84	132,54	133,68	114	180,29	181,43
25	38,64	39,78	55	86,39	87,53	85	134,14	135,28	115	181,88	183,02
26	40,24	41,38	56	87,98	89,12	86	135,73	136,87	116	183,47	184,61
27	41,83	42,97	57	89,57	90,71	87	137,32	138,46	117	185,07	186,21
28	43,42	44,56	58	91,17	92,31	88	138,91	140,05	118	186,66	187,80
29	45,01	46,15	59	92,76	93,90	89	140,51	141,65	119	188,25	189,39
30	46,61	47,75	60	94,35	95,49	90	142,10	143,24	120	189,84	190,98
31	48,19	49,33	61	95,94	97,08	91	143,69	144,83			
32	49,79	50,93	62	97,53	98,67	92	145,28	146,42			
33	51,38	52,52	63	99,12	100,26	93	146,87	148,01			
34	52,97	54,11	64	100,72	101,86	94	148,46	149,60			
35	54,56	55,70	65	102,31	103,45	95	150,06	151,20			
36	56,16	57,30	66	103,90	105,04	96	151,64	152,78			
37	57,75	58,89	67	105,49	106,63	97	153,24	154,38			
38	59,34	60,48	68	107,08	108,22	98	154,83	155,97			
39	60,93	62,07	69	108,67	109,81	99	156,42	157,56			

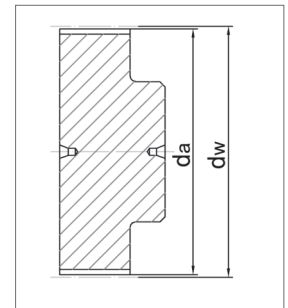

RTD 8M

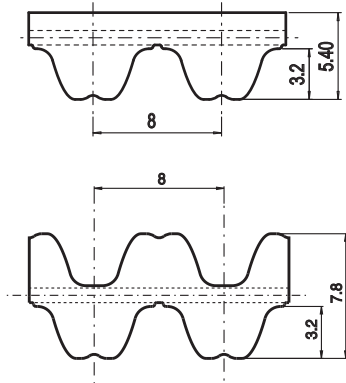

Belt characteristics

- Polyurethane timing belt with round tooth profile and high tensile load tension cords. Produced according to ISO 13050
- Metric pitch 8 mm
- The tooth profile allows a uniform load distribution that guarantees high performances, high transmissible torque and precise tooth engagement.
- PAZ fabric on tooth side delivered as standard reduces noise in the drive
- Widely used in linear positioning, medium power transmission applications

- Width tolerance: $\pm 0,5$ [mm]
- Length tolerance: $\pm 0,5$ [mm/m]
- Thickness tolerance: $\pm 0,2$ [mm]

Technical Data

Belt width b [mm]	Allowable tensile load Type M F_{Tzul} [N]	Allowable tensile load Type V F_{Tzul} [N]	Breaking load Type M F_{Br} [N]	Specific spring rate C_{spez} [N]	Weight [kg/m]
10	1470	735	5700	367500	0,07
15	2210	1105	8550	552500	0,10
20	3190	1595	12350	797500	0,14
30	4660	2330	18050	1165000	0,20
50	8580	4290	33250	2145000	0,35
85	14700	7350	57000	3675000	0,60
100	17400	8700	67450	4350000	0,75

Other widths are available on request.

Load / Elongation [%]

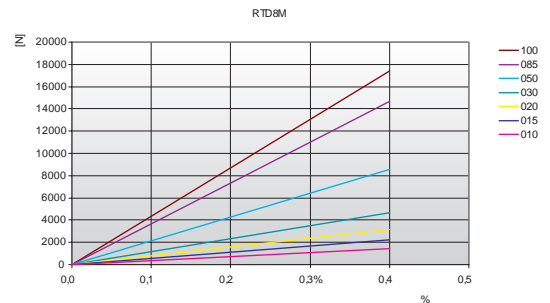

Tooth shear strength

rpm	F_{Uspez} [N/cm]	rpm	F_{Uspez} [N/cm]	rpm	F_{Uspez} [N/cm]	rpm	F_{Uspez} [N/cm]
0	76,00	800	53,20	1900	41,52	4000	30,44
20	74,62	900	51,71	2000	40,78	4500	28,63
40	73,34	1000	50,35	2200	39,39	5000	27,00
60	72,16	1100	49,09	2400	38,12	5500	25,51
80	71,07	1200	47,93	2600	36,94	6000	24,15
100	70,07	1300	46,84	2800	35,83	-	-
200	66,09	1400	45,82	2880	35,41	-	-
300	63,68	1440	45,43	3000	34,80	-	-
400	61,03	1500	44,86	3200	33,83	-	-
500	58,71	1600	43,96	3400	32,91	-	-
600	56,66	1700	43,10	3600	32,05	-	-
700	54,84	1800	42,29	3800	31,22	-	-

Tooth shear strength / rpm

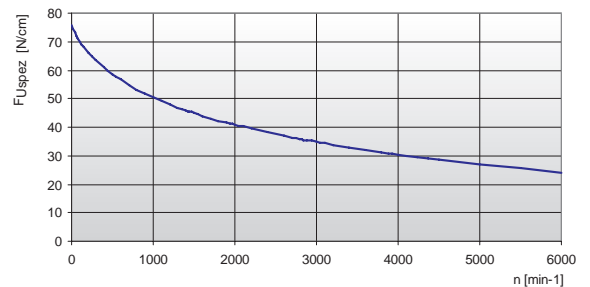

The specific load F_{Uspez} is the maximum load which one single belt tooth 1 cm wide can withstand in all operating conditions.

This force is related to the drive rpm.

The total load F_u transmissible by the belt in the drive is calculated by:



$$F_u [N] = F_{Uspez} \cdot Z_e \cdot b$$

- F_u [N] = peripheral force
- F_{Uspez} [N/cm] = specific load
- Z_e = number of teeth in mesh in the small pulley
- Z_{emax} = max. no of teeth in mesh to be considered for the calculation of the drive
- Z_{emax} = 12 for ELATECH® M
- Z_{emax} = 6 for ELATECH® V
- b [cm] = belt width in cm

Specialties

Belt width b [mm]	ARAMID CORD		STAINLESS STEEL		HPL High Performance	
	F_{Tzul} [N] M type	F_{Br} [N]	F_{Tzul} [N] M type	F_{Br} [N]	F_{Tzul} [N] M type	F_{Br} [N]
10	1140	4740	1080	4500	-	-
15	1710	7110	1620	6750	-	-
20	2470	10270	2340	9750	5280	19250
30	3800	15800	3600	15000	8640	31500
50	6650	27650	6300	26250	14400	52500
85	11400	47400	-	-	25440	92750
100	13500	56000	-	-	29280	106750

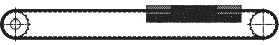
Flexibility

Minimum pulley number of teeth and minimum idler diameter		Type of cord			
		STANDARD	ARAMID	STAINLESS	HPL
Drive without reverse bending 	Timing pulley z_{min}	18	18	24	30
	Flat idler running on belt teeth d_{min}	50 mm	50 mm	70 mm	80 mm
Drive with reverse bending 	Timing pulley z_{min}	30	30	40	30
	Flat idler running on belt back d_{min}	120 mm	120 mm	120 mm	150 mm

Timing pulleys

z	da	dw	z	da	dw	z	da	dw	z	da	dw
18	44,46	45,83	48	120,86	122,23	78	197,25	198,62	108	273,64	275,01
19	47,01	48,38	49	123,40	124,77	79	199,80	201,17	109	276,19	277,56
20	49,56	50,93	50	125,95	127,32	80	202,35	203,72	110	278,74	280,11
21	52,10	53,47	51	128,50	129,87	81	204,89	206,26	111	281,29	282,66
22	54,65	56,02	52	131,05	132,41	82	207,44	208,81	112	283,84	285,21
23	57,20	58,57	53	133,59	134,96	83	209,98	211,35	113	286,38	287,75
24	59,75	61,12	54	136,14	137,51	84	212,53	213,90	114	288,93	290,30
25	62,29	63,66	55	138,68	140,05	85	215,08	216,45	115	291,47	292,84
26	64,84	66,21	56	141,23	142,60	86	217,63	219,00	116	294,02	295,39
27	67,38	68,75	57	143,78	145,15	87	220,17	221,54	117	296,57	297,94
28	70,08	71,30	58	146,32	147,69	88	222,72	224,09	118	299,11	300,48
29	72,59	73,84	59	148,87	150,24	89	225,26	226,63	119	301,66	303,03
30	75,13	76,39	60	151,42	152,79	90	227,81	229,18	120	304,20	305,57
31	77,65	78,94	61	153,96	155,33	91	230,35	231,72			
32	80,16	81,49	62	156,52	157,89	92	232,90	234,27			
33	82,68	84,03	63	159,06	160,43	93	235,45	236,82			
34	85,21	86,58	64	161,60	162,97	94	238,00	239,37			
35	87,76	89,12	65	164,15	165,52	95	240,54	241,91			
36	90,30	91,67	66	166,69	168,06	96	243,09	244,46			
37	92,85	94,22	67	169,24	170,61	97	245,63	247,00			
38	95,40	96,77	68	171,79	173,16	98	248,18	249,55			
39	97,94	99,31	69	174,33	175,70	99	250,73	252,10			
40	100,49	101,86	70	176,88	178,25	100	253,28	254,67			
41	103,04	104,40	71	179,43	180,80	101	255,82	257,19			
42	105,58	106,95	72	181,98	183,35	102	258,37	259,74			
43	108,13	109,50	73	184,52	185,89	103	260,91	262,28			
44	110,68	112,05	74	187,07	188,44	104	263,46	264,83			
45	113,22	114,59	75	189,61	190,98	105	266,01	267,38			
46	115,77	117,14	76	192,16	193,53	106	268,55	269,92			
47	118,31	119,68	77	194,71	196,08	107	271,10	272,47			

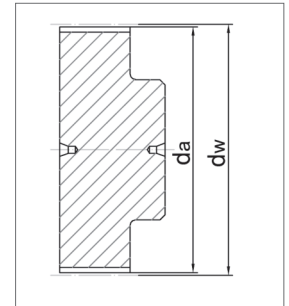

RTD 14M

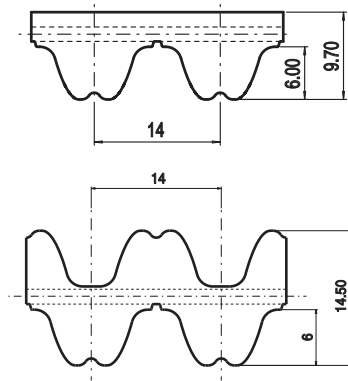

Belt characteristics

- Polyurethane timing belt with round tooth profile and high tensile load tension cords. Produced according to ISO 13050
- Metric pitch 14 mm
- The tooth profile, allows a uniform load distribution that guarantees high performances high transmissible torque and precise tooth engagement
- PAZ fabric on tooth side delivered as standard reduces noise in the drive
- Widely used in linear positioning, heavy power transmission applications

- Width tolerance: $\pm 1,0$ [mm]
- Length tolerance: $\pm 0,5$ [mm/m]
- Thickness tolerance: $\pm 0,4$ [mm]

Technical Data

Belt width b [mm]	Allowable tensile load Type M F_{Tzul} [N]	Allowable tensile load Type V F_{Tzul} [N]	Breaking load Type M F_{Br} [N]	Specific spring rate C_{spez} [N]	Weight [kg/m]
40	12750	6375	48000	3187500	0,48
55	17850	8925	67200	4462500	0,68
85	28050	14025	105600	7012500	1,00
115	39100	19550	147200	9775000	1,40

Other widths are available on request.

Load / Elongation [%]

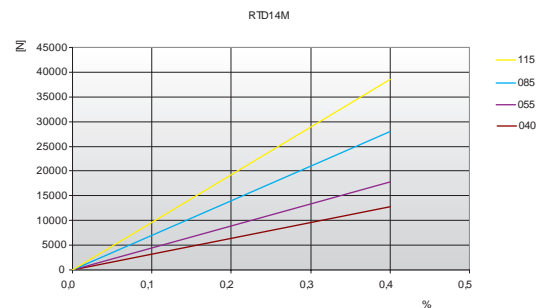

Tooth shear strength

rpm	F_{Uspez} [N/cm]	rpm	F_{Uspez} [N/cm]	rpm	F_{Uspez} [N/cm]	rpm	F_{Uspez} [N/cm]
0	140,00	800	93,80	1900	70,49	4000	48,24
20	137,31	900	90,85	2000	69,01	-	-
40	134,83	1000	88,14	2200	66,23	-	-
60	132,53	1100	85,63	2400	63,68	-	-
80	130,42	1200	83,31	2600	61,30	-	-
100	128,46	1300	81,14	2800	59,09	-	-
200	119,77	1400	79,11	2880	58,24	-	-
300	114,29	1440	78,33	3000	57,01	-	-
400	109,19	1500	77,19	3200	55,06	-	-
500	104,65	1600	75,38	3400	53,22	-	-
600	100,64	1700	73,67	3600	51,48	-	-
700	97,04	1800	72,04	3800	49,82	-	-

Tooth shear strength / rpm

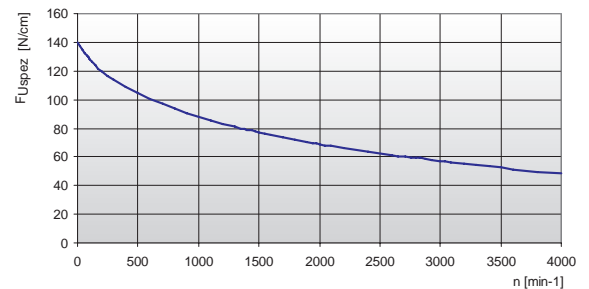

The specific load F_{Uspez} is the maximum load which one single belt tooth 1 cm wide can withstand in all operating conditions. This force is related to the drive rpm. The total load F_U transmissible by the belt in the drive is calculated by:

$$F_U [N] = F_{Uspez} \cdot Z_e \cdot b$$

- $F_U [N]$ = peripheral force
- $F_{Uspez} [N/cm]$ = specific load
- Z_e = number of teeth in mesh in the small pulley
- Z_{emax} = max. no of teeth in mesh to be considered for the calculation of the drive
- Z_{emax} = 12 for ELATECH® M
- Z_{emax} = 6 for ELATECH® V
- $b [cm]$ = belt width in cm

Flexibility

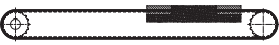
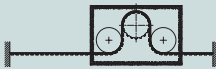
Minimum pulley number of teeth and minimum idler diameter		Type of cord
		STANDARD
Drive without reverse bending 	Timing pulley z_{min}	32
	Flat idler running on belt teeth d_{min}	140 mm
Drive with reverse bending 	Timing pulley z_{min}	32
	Flat idler running on belt back d_{min}	200 mm

Timing pulleys

z	da	dw
28	122,12	124,77
29	126,58	129,22
30	130,99	133,69
31	135,45	138,14
32	139,88	142,59
33	144,35	147,06
34	148,79	151,51
35	153,25	155,96
36	157,68	160,41
37	162,14	164,88
38	166,60	169,34
39	171,02	173,79
40	175,48	178,24
41	179,92	182,71
42	184,37	187,16
43	188,83	191,61
44	193,29	196,08
45	197,75	200,53
46	202,21	204,98
47	206,65	209,43
48	211,11	213,90
49	215,57	218,35
50	220,03	222,80
51	224,49	227,27
52	228,95	231,72
53	233,39	236,18
54	237,85	240,64
55	242,30	245,09
56	246,76	249,55
57	251,22	254,01

z	da	dw
58	255,68	258,46
59	260,14	262,91
60	264,60	267,38
61	269,04	271,83
62	273,50	276,28
63	277,96	280,75
64	282,42	285,20
65	286,88	289,65
66	291,32	294,11
67	295,78	298,56
68	300,24	303,03
69	304,70	307,48
70	309,16	311,93
71	313,61	316,40
72	318,07	320,85
73	322,53	325,30
74	326,98	329,77
75	331,44	334,22
76	335,90	338,67
77	340,34	343,12
78	344,80	347,59
79	349,26	352,04
80	353,72	356,49
81	358,17	360,96
82	362,63	365,41
83	367,09	369,86
84	371,54	374,33
85	376,00	378,78
86	380,46	383,23
87	384,91	387,70

z	da	dw
88	389,37	392,15
89	393,83	396,60
90	398,29	401,07
91	402,73	405,52
92	407,19	409,97
93	411,65	414,44
94	416,10	418,89
95	420,56	423,35
96	425,02	427,80
97	429,48	432,25
98	433,94	436,72
99	438,38	441,17
100	442,84	445,62
101	447,30	450,09
102	451,76	454,54
103	456,21	459,00
104	460,67	463,45
105	465,13	467,90
106	469,58	472,37
107	474,03	476,82
108	478,49	481,28
109	482,95	485,74
110	487,41	490,19
111	491,87	494,64
112	496,32	499,10
113	500,78	503,55
114	505,23	508,02
116	514,14	516,93
117	518,60	521,38
118	523,06	525,83

z	da	dw
119	527,51	530,30
120	531,97	534,75

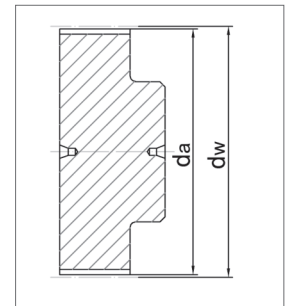

RTD 14M HPL

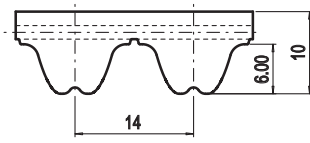

Belt characteristics

- Polyurethane timing belt with round tooth profile and high tensile load tension cords. Produced according to ISO 13050
- Metric pitch 14 mm
- The tooth profile, allows a uniform load distribution that guarantees high performances high transmissible torque and precise tooth engagement
- PAZ fabric on tooth side delivered as standard reduces noise in the drive
- **RTD14M - HPL is the ideal belt for heavy duty synchronous lifting applications. Black colour as standard.**

- Width tolerance: $\pm 1,0$ [mm]
- Length tolerance: $\pm 0,5$ [mm/m]
- Thickness tolerance: $\pm 0,4$ [mm]

Technical Data

Belt width b [mm]	Allowable tensile load Type M F_{Tzul} [N]	Breaking load Type M F_{Br} [N]	Specific spring rate C_{spez} [N]	Weight [kg/m]
40	14300	58500	3575000	0,49
55	19800	81000	4950000	0,82
75	27500	112500	6875000	1,13
85	30800	126000	7700000	1,25
100	35200	144000	8800000	1,51
115	41800	171000	10450000	1,76
150	55000	225000	13750000	2,29

Other widths are available on request.

Load / Elongation [%]

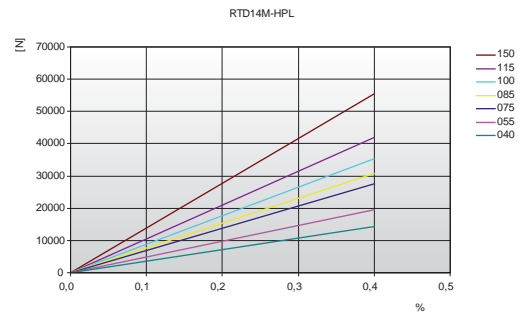

Tooth shear strength

rpm	F_{Uspez} [N/cm]	rpm	F_{Uspez} [N/cm]	rpm	F_{Uspez} [N/cm]	rpm	F_{Uspez} [N/cm]
0	140,00	800	93,80	1900	70,49	4000	48,24
20	137,31	900	90,85	2000	69,01	-	-
40	134,83	1000	88,14	2200	66,23	-	-
60	132,53	1100	85,63	2400	63,68	-	-
80	130,42	1200	83,31	2600	61,30	-	-
100	128,46	1300	81,14	2800	59,09	-	-
200	119,77	1400	79,11	2880	58,24	-	-
300	114,29	1440	78,33	3000	57,01	-	-
400	109,19	1500	77,19	3200	55,06	-	-
500	104,65	1600	75,38	3400	53,22	-	-
600	100,64	1700	73,67	3600	51,48	-	-
700	97,04	1800	72,04	3800	49,82	-	-

Tooth shear strength / rpm

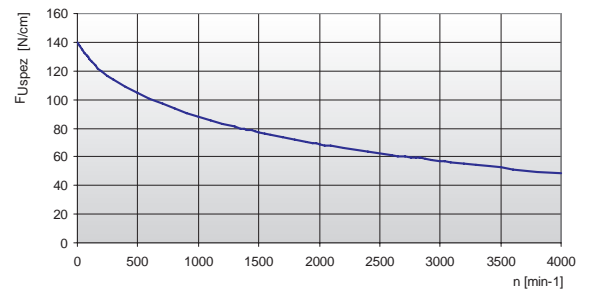

The specific load F_{Uspez} is the maximum load which one single belt tooth 1 cm wide can withstand in all operating conditions. This force is related to the drive rpm. The total load F_U transmissible by the belt in the drive is calculated by:

$$F_U \text{ [N]} = F_{Uspez} \cdot Z_e \cdot b$$

- F_U [N] = peripheral force
- F_{Uspez} [N/cm] = specific load
- Z_e = number of teeth in mesh in the small pulley
- Z_{emax} = max. no of teeth in mesh to be considered for the calculation of the drive
- Z_{emax} = 12 for ELATECH® M
- Z_{emax} = 6 for ELATECH® V
- b [cm] = belt width in cm

Flexibility

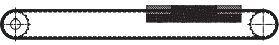
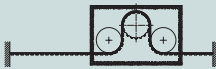
Minimum pulley number of teeth and minimum idler diameter		Type of cord
		STANDARD
Drive without reverse bending 	Timing pulley z_{min}	32
	Flat idler running on belt teeth d_{min}	140 mm
Drive with reverse bending 	Timing pulley z_{min}	32
	Flat idler running on belt back d_{min}	200 mm

Timing pulleys

z	da	dw	z	da	dw	z	da	dw	z	da	dw
28	122,12	124,77	58	255,68	258,46	88	389,37	392,15	119	527,51	530,30
29	126,58	129,22	59	260,14	262,91	89	393,83	396,60	120	531,97	534,75
30	130,99	133,69	60	264,60	267,38	90	398,29	401,07			
31	135,45	138,14	61	269,04	271,83	91	402,73	405,52			
32	139,88	142,59	62	273,50	276,28	92	407,19	409,97			
33	144,35	147,06	63	277,96	280,75	93	411,65	414,44			
34	148,79	151,51	64	282,42	285,20	94	416,10	418,89			
35	153,25	155,96	65	286,88	289,65	95	420,56	423,35			
36	157,68	160,41	66	291,32	294,11	96	425,02	427,80			
37	162,14	164,88	67	295,78	298,56	97	429,48	432,25			
38	166,60	169,34	68	300,24	303,03	98	433,94	436,72			
39	171,02	173,79	69	304,70	307,48	99	438,38	441,17			
40	175,48	178,24	70	309,16	311,93	100	442,84	445,62			
41	179,92	182,71	71	313,61	316,40	101	447,30	450,09			
42	184,37	187,16	72	318,07	320,85	102	451,76	454,54			
43	188,83	191,61	73	322,53	325,30	103	456,21	459,00			
44	193,29	196,08	74	326,98	329,77	104	460,67	463,45			
45	197,75	200,53	75	331,44	334,22	105	465,13	467,90			
46	202,21	204,98	76	335,90	338,67	106	469,58	472,37			
47	206,65	209,43	77	340,34	343,12	107	474,03	476,82			
48	211,11	213,90	78	344,80	347,59	108	478,49	481,28			
49	215,57	218,35	79	349,26	352,04	109	482,95	485,74			
50	220,03	222,80	80	353,72	356,49	110	487,41	490,19			
51	224,49	227,27	81	358,17	360,96	111	491,87	494,64			
52	228,95	231,72	82	362,63	365,41	112	496,32	499,10			
53	233,39	236,18	83	367,09	369,86	113	500,78	503,55			
54	237,85	240,64	84	371,54	374,33	114	505,23	508,02			
55	242,30	245,09	85	376,00	378,78	116	514,14	516,93			
56	246,76	249,55	86	380,46	383,23	117	518,60	521,38			
57	251,22	254,01	87	384,91	387,70	118	523,06	525,83			

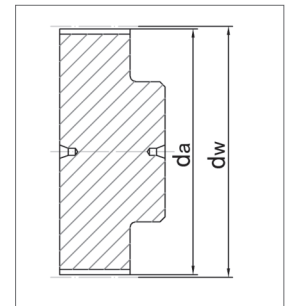

RTD 14M XHPL

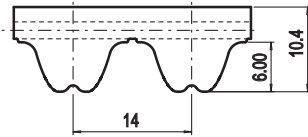

Belt characteristics

- Polyurethane timing belt with round tooth profile and high tensile load tension cords. Produced according to ISO 13050
- Metric pitch 14 mm
- The tooth profile, allows a uniform load distribution that guarantees high performances high transmissible torque and precise tooth engagement
- PAZ fabric on tooth side delivered as standard reduces noise in the drive
- **RTD14M - XHPL is the ideal belt for heavy duty synchronous lifting applications. Black colour as standard.**

- Width tolerance: $\pm 1,0$ [mm]
- Length tolerance: $\pm 0,5$ [mm/m]
- Thickness tolerance: $\pm 0,4$ [mm]

Technical Data

Belt width b [mm]	Allowable tensile load Type M F_{Tzul} [N]	Breaking load Type M F_{Br} [N]	Specific spring rate C_{spez} [N]	Weight [kg/m]
40	22000	77000	5500000	0,59
55	32000	112000	8000000	0,75
85	50000	175000	12500000	1,29
115	68000	238000	17000000	1,75
150	90000	315000	22500000	2,21

Other widths are available on request.

Load / Elongation [%]

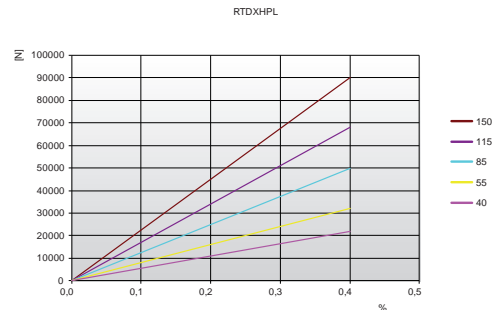

Tooth shear strength

rpm	F_{Uspez} [N/cm]	rpm	F_{Uspez} [N/cm]	rpm	F_{Uspez} [N/cm]	rpm	F_{Uspez} [N/cm]
0	140,00	800	93,80	1900	70,49	4000	48,24
20	137,31	900	90,85	2000	69,01	-	-
40	134,83	1000	88,14	2200	66,23	-	-
60	132,53	1100	85,63	2400	63,68	-	-
80	130,42	1200	83,31	2600	61,30	-	-
100	128,46	1300	81,14	2800	59,09	-	-
200	119,77	1400	79,11	2880	58,24	-	-
300	114,29	1440	78,33	3000	57,01	-	-
400	109,19	1500	77,19	3200	55,06	-	-
500	104,65	1600	75,38	3400	53,22	-	-
600	100,64	1700	73,67	3600	51,48	-	-
700	97,04	1800	72,04	3800	49,82	-	-

Tooth shear strength / rpm

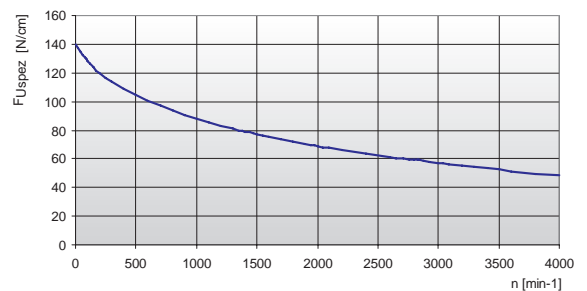



The specific load F_{Uspez} is the maximum load which one single belt tooth 1 cm wide can withstand in all operating conditions. This force is related to the drive rpm. The total load F_U transmissible by the belt in the drive is calculated by:

$$F_U [N] = F_{Uspez} \cdot Z_e \cdot b$$

- $F_U [N]$ = peripheral force
- $F_{Uspez} [N/cm]$ = specific load
- Z_e = number of teeth in mesh in the small pulley
- Z_{emax} = max. no of teeth in mesh to be considered for the calculation of the drive
- Z_{emax} = 12 for ELATECH® M
- Z_{emax} = 6 for ELATECH® V
- $b [cm]$ = belt width in cm

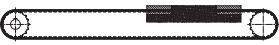
Flexibility

Minimum pulley number of teeth and minimum idler diameter		Type of cord
		STANDARD
Drive without reverse bending 	Timing pulley z_{min}	34
	Flat idler running on belt teeth d_{min}	140 mm
Drive with reverse bending 	Timing pulley z_{min}	34
	Flat idler running on belt back d_{min}	250 mm

Timing pulleys

z	da	dw
28	122,12	124,77
29	126,58	129,22
30	130,99	133,69
31	135,45	138,14
32	139,88	142,59
33	144,35	147,06
34	148,79	151,51
35	153,25	155,96
36	157,68	160,41
37	162,14	164,88
38	166,60	169,34
39	171,02	173,79
40	175,48	178,24
41	179,92	182,71
42	184,37	187,16
43	188,83	191,61
44	193,29	196,08
45	197,75	200,53
46	202,21	204,98
47	206,65	209,43
48	211,11	213,90
49	215,57	218,35
50	220,03	222,80
51	224,49	227,27
52	228,95	231,72
53	233,39	236,18
54	237,85	240,64
55	242,30	245,09
56	246,76	249,55
57	251,22	254,01

z	da	dw
58	255,68	258,46
59	260,14	262,91
60	264,60	267,38
61	269,04	271,83
62	273,50	276,28
63	277,96	280,75
64	282,42	285,20
65	286,88	289,65
66	291,32	294,11
67	295,78	298,56
68	300,24	303,03
69	304,70	307,48
70	309,16	311,93
71	313,61	316,40
72	318,07	320,85
73	322,53	325,30
74	326,98	329,77
75	331,44	334,22
76	335,90	338,67
77	340,34	343,12
78	344,80	347,59
79	349,26	352,04
80	353,72	356,49
81	358,17	360,96
82	362,63	365,41
83	367,09	369,86
84	371,54	374,33
85	376,00	378,78
86	380,46	383,23
87	384,91	387,70

z	da	dw
88	389,37	392,15
89	393,83	396,60
90	398,29	401,07
91	402,73	405,52
92	407,19	409,97
93	411,65	414,44
94	416,10	418,89
95	420,56	423,35
96	425,02	427,80
97	429,48	432,25
98	433,94	436,72
99	438,38	441,17
100	442,84	445,62
101	447,30	450,09
102	451,76	454,54
103	456,21	459,00
104	460,67	463,45
105	465,13	467,90
106	469,58	472,37
107	474,03	476,82
108	478,49	481,28
109	482,95	485,74
110	487,41	490,19
111	491,87	494,64
112	496,32	499,10
113	500,78	503,55
114	505,23	508,02
116	514,14	516,93
117	518,60	521,38
118	523,06	525,83

z	da	dw
119	527,51	530,30
120	531,97	534,75

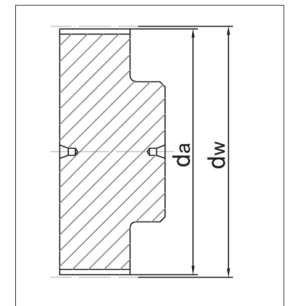

Note

Special pulley profile required.
Contact ELATECH Technical Dept. for details.

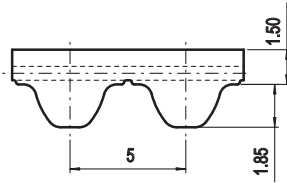

Belt characteristics

- Polyurethane timing belt with involute tooth, high tensile load steel cords and high torque capacity. Produced according to ISO 13050
- Metric pitch 5 mm
- Low noise generation in high speed drives
- Offers excellent operational reliability in linear positioning and light power transmission applications
- The special profile allows smooth running properties

- Width tolerance: $\pm 0,5$ [mm]
- Length tolerance: $\pm 0,5$ [mm/m]
- Thickness tolerance: $\pm 0,2$ [mm]

Technical Data

Belt width b [mm]	Allowable tensile load Type M F_{Tzul} [N]	Allowable tensile load Type V F_{Tzul} [N]	Breaking load Type M F_{Br} [N]	Specific spring rate C_{spez} [N]	Weight [kg/m]
10	920	460	3360	230000	0,05
15	1500	750	5460	375000	0,07
25	2650	1325	9660	662500	0,12
50	5520	2760	20160	1380000	0,23
100	11270	5635	41160	2817500	0,46

Other widths are available on request.

Load / Elongation [%]

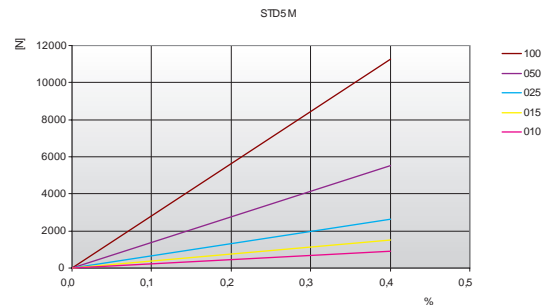

Tooth shear strength

rpm	F_{Uspez} [N/cm]	rpm	F_{Uspez} [N/cm]	rpm	F_{Uspez} [N/cm]	rpm	F_{Uspez} [N/cm]
0	36,90	800	27,71	1900	22,74	4500	16,90
20	36,35	900	27,11	2000	22,41	5000	16,14
40	35,85	1000	26,55	2200	21,80	5500	15,45
60	35,40	1100	26,02	2400	21,22	6000	14,82
80	34,99	1200	25,53	2600	20,69	6500	14,24
100	34,62	1300	25,06	2800	20,19	7000	13,69
200	33,23	1400	24,63	3000	19,73	7500	13,18
300	31,37	1440	24,46	3200	19,28	8000	12,70
400	30,60	1500	24,21	3400	18,87	8500	12,25
500	29,81	1600	23,82	3600	18,47	9000	11,83
600	29,06	1700	23,44	3800	18,09	9500	11,42
700	28,36	1800	23,08	4000	17,73	10000	11,03

Tooth shear strength / rpm

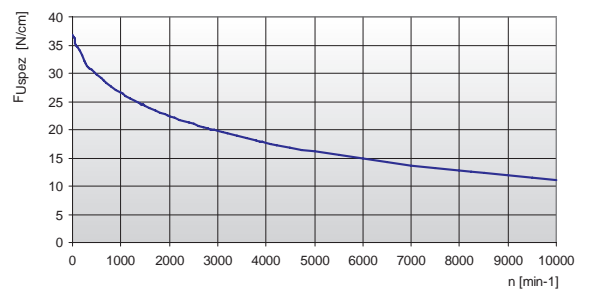

The specific load F_{Uspez} is the maximum load which one single belt tooth 1 cm wide can withstand in all operating conditions.

This force is related to the drive rpm.

The total load F_u transmissible by the belt in the drive is calculated by:

$$F_u [N] = F_{Uspez} \cdot Z_e \cdot b$$



- F_u [N] = peripheral force
- F_{Uspez} [N/cm] = specific load
- Z_e = number of teeth in mesh in the small pulley
- Z_{emax} = max. no of teeth in mesh to be considered for the calculation of the drive
- Z_{emax} = 12 for ELATECH® M
- Z_{emax} = 6 for ELATECH® V
- b [cm] = belt width in cm

STD 5M

Specialties

Belt width b [mm]	ARAMID CORD		STAINLESS STEEL		HFE High Flexibility	
	F_{Tzul} [N] M type	F_{Br} [N]	F_{Tzul} [N] M type	F_{Br} [N]	F_{Tzul} [N] M type	F_{Br} [N]
10	880	3600	600	2400	960	3440
15	1430	5850	980	3900	1560	5590
25	2530	10350	1730	6900	2760	9890
50	5280	21600	3600	14400	5760	20640
100	10780	44100	-	-	11760	42140

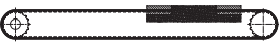
Flexibility

Minimum pulley number of teeth and minimum idler diameter		Type of cord			
		STANDARD	ARAMID	STAINLESS	HFE
Drive without reverse bending 	Timing pulley z_{min}	16	16	18	15
	Flat idler running on belt teeth d_{min}	30 mm	30 mm	40 mm	40 mm
Drive with reverse bending 	Timing pulley z_{min}	25	25	25	20
	Flat idler running on belt back d_{min}	60 mm	60 mm	65 mm	40 mm

Timing pulleys

z	da	dw	z	da	dw	z	da	dw	z	da	dw
10	14,95	15,91	40	62,70	63,66	70	110,45	111,41	100	158,19	159,15
11	16,54	17,50	41	64,30	65,26	71	112,04	113,00	101	159,79	160,75
12	18,14	19,10	42	65,89	66,85	72	113,63	114,59	102	161,38	162,34
13	19,73	20,69	43	67,48	68,44	73	115,23	116,19	103	162,99	163,95
14	21,32	22,28	44	69,07	70,03	74	116,82	117,78	104	164,56	165,52
15	22,91	23,87	45	70,66	71,62	75	118,41	119,37	105	166,15	167,11
16	24,51	25,47	46	72,25	73,21	76	120,00	120,96	106	167,74	168,70
17	26,10	27,06	47	73,84	74,80	77	121,59	122,55	107	169,34	170,3
18	27,69	28,65	48	75,43	76,39	78	123,18	124,14	108	170,93	171,89
19	29,27	30,23	49	77,03	77,99	79	124,77	125,73	109	172,52	173,48
20	30,87	31,83	50	78,62	79,58	80	126,36	127,32	110	174,10	175,06
21	32,46	33,42	51	80,21	81,17	81	127,95	128,91	111	175,7	176,66
22	34,05	35,01	52	81,80	82,76	82	129,54	130,50	112	177,29	178,25
23	35,65	36,61	53	83,39	84,35	83	131,14	132,10	113	178,88	179,84
24	37,23	38,19	54	84,99	85,95	84	132,73	133,69	114	180,47	181,43
25	38,83	39,79	55	86,58	87,54	85	134,32	135,28	115	182,06	183,02
26	40,42	41,38	56	88,17	89,13	86	135,91	136,87	116	183,65	184,61
27	42,01	42,97	57	89,76	90,72	87	137,51	138,47	117	185,25	186,21
28	43,60	44,56	58	91,35	92,31	88	139,09	140,05	118	186,84	187,8
29	45,19	46,15	59	92,94	93,90	89	140,69	141,65	119	188,43	189,39
30	46,79	47,75	60	94,53	95,49	90	142,28	143,24	120	190,02	190,98
31	48,38	49,34	61	96,13	97,09	91	143,87	144,83			
32	49,97	50,93	62	97,72	98,68	92	145,46	146,42			
33	51,56	52,52	63	99,31	100,27	93	147,05	148,01			
34	53,15	54,11	64	100,90	101,86	94	148,64	149,60			
35	54,75	55,71	65	102,49	103,45	95	150,24	151,20			
36	56,34	57,30	66	104,08	105,04	96	151,83	152,71			
37	57,93	58,89	67	105,67	106,63	97	153,42	154,38			
38	59,52	60,48	68	107,27	108,23	98	155,01	155,97			
39	61,11	62,07	69	108,86	109,82	99	156,60	157,56			

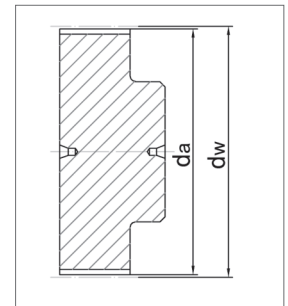

STD 8M

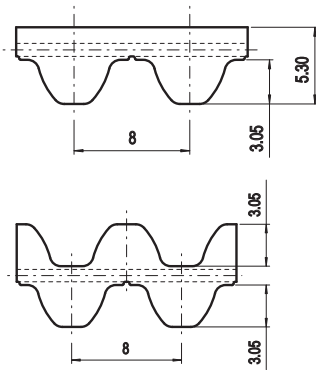

Belt characteristics

- Polyurethane timing belt with involute tooth, high tensile load steel cords and high torque capacity. Produced according to ISO 13050
- Metric pitch 8 mm
- Low noise generation in high speed drives
- Offers excellent operational reliability in linear positioning and medium power transmission applications
- Widely used in automatic doors
- The special profile allows smooth running properties

- Width tolerance: $\pm 0,5$ [mm]
- Length tolerance: $\pm 0,5$ [mm/m]
- Thickness tolerance: $\pm 0,2$ [mm]

Technical Data

Belt width b [mm]	Allowable tensile load Type M F_{Tzul} [N]	Allowable tensile load Type V F_{Tzul} [N]	Breaking load Type M F_{Br} [N]	Specific spring rate C_{spez} [N]	Weight [kg/m]
10	1470	735	5700	367500	0,07
15	2210	1105	8550	552500	0,10
20	3190	1595	12350	797500	0,13
30	4660	2330	18050	1165000	0,20
50	8580	4290	33250	2145000	0,33
85	14700	7350	57000	3675000	0,56
100	17400	8700	67450	4350000	0,66

Other widths are available on request.

Load / Elongation [%]

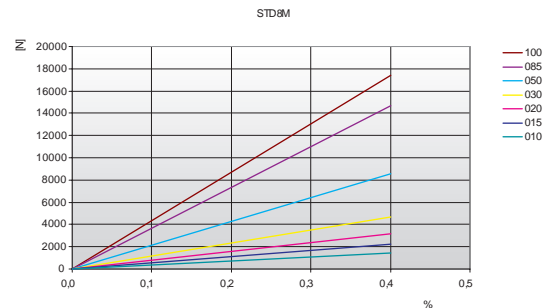

Tooth shear strength

rpm	F_{Uspez} [N/cm]	rpm	F_{Uspez} [N/cm]	rpm	F_{Uspez} [N/cm]	rpm	F_{Uspez} [N/cm]
0	74,10	800	51,53	1900	39,76	4500	26,79
20	73,05	900	50,03	2000	39,02	5000	25,14
40	72,06	1000	48,66	2200	37,62	5500	23,65
60	71,13	1100	47,39	2400	36,34	6000	22,28
80	70,26	1200	46,22	2600	35,15	-	-
100	69,43	1300	45,12	2800	34,04	-	-
200	65,98	1400	44,10	3000	33,00	-	-
300	62,11	1440	43,70	3200	32,02	-	-
400	59,43	1500	43,13	3400	31,10	-	-
500	57,08	1600	42,22	3600	30,23	-	-
600	55,02	1700	41,36	3800	29,40	-	-
700	53,18	1800	40,54	4000	28,61	-	-

Tooth shear strength / rpm

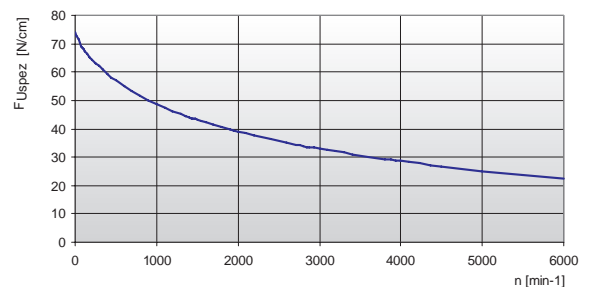

The specific load F_{Uspez} is the maximum load which one single belt tooth 1 cm wide can withstand in all operating conditions. This force is related to the drive rpm. The total load F_u transmissible by the belt in the drive is calculated by:



$$F_u [N] = F_{Uspez} \cdot Z_e \cdot b$$

- F_u [N] = peripheral force
- F_{Uspez} [N/cm] = specific load
- Z_e = number of teeth in mesh in the small pulley
- Z_{emax} = max. no of teeth in mesh to be considered for the calculation of the drive
- Z_{emax} = 12 for ELATECH® M
- Z_{emax} = 6 for ELATECH® V
- b [cm] = belt width in cm

Specialties

Belt width b [mm]	ARAMID CORD		STAINLESS STEEL		HPL High Performance	
	F_{Tzul} [N] M type	F_{Br} [N]	F_{Tzul} [N] M type	F_{Br} [N]	F_{Tzul} [N] M type	F_{Br} [N]
10	1140	4740	1080	4500	-	-
15	1710	7110	1620	6750	-	-
20	2470	10270	2340	9750	5280	19250
30	3800	15800	3600	15000	8640	31500
50	6650	27650	6300	26250	14400	52500
85	11400	47400	-	-	25440	92750
100	13500	56000	-	-	29280	106750

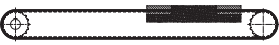
Flexibility

Minimum pulley number of teeth and minimum idler diameter		Type of cord			
		STANDARD	ARAMID	STAINLESS	HPL
Drive without reverse bending 	Timing pulley z_{min}	18	18	24	30
	Flat idler running on belt teeth d_{min}	50 mm	50 mm	70 mm	80 mm
Drive with reverse bending 	Timing pulley z_{min}	30	30	40	30
	Flat idler running on belt back d_{min}	120 mm	120 mm	120 mm	150 mm

Timing pulleys

z	da	dw	z	da	dw	z	da	dw	z	da	dw
18	44,46	45,83	48	120,86	122,23	78	197,25	198,62	108	273,64	275,01
19	47,01	48,38	49	123,40	124,77	79	199,80	201,17	109	276,19	277,56
20	49,56	50,93	50	125,95	127,32	80	202,35	203,72	110	278,74	280,11
21	52,10	53,47	51	128,50	129,87	81	204,89	206,26	111	281,29	282,66
22	54,65	56,02	52	131,05	132,41	82	207,44	208,81	112	283,84	285,21
23	57,20	58,57	53	133,59	134,96	83	209,98	211,35	113	286,38	287,75
24	59,75	61,12	54	136,14	137,51	84	212,53	213,90	114	288,93	290,30
25	62,29	63,66	55	138,68	140,05	85	215,08	216,45	115	291,47	292,84
26	64,84	66,21	56	141,23	142,60	86	217,63	219,00	116	294,02	295,39
27	67,38	68,75	57	143,78	145,15	87	220,17	221,54	117	296,57	297,94
28	70,08	71,30	58	146,32	147,69	88	222,72	224,09	118	299,11	300,48
29	72,59	73,84	59	148,87	150,24	89	225,26	226,63	119	301,66	303,03
30	75,13	76,39	60	151,42	152,79	90	227,81	229,18	120	304,20	305,57
31	77,65	78,94	61	153,96	155,33	91	230,35	231,72			
32	80,16	81,49	62	156,52	157,89	92	232,90	234,27			
33	82,68	84,03	63	159,06	160,43	93	235,45	236,82			
34	85,21	86,58	64	161,60	162,97	94	238,00	239,37			
35	87,76	89,12	65	164,15	165,52	95	240,54	241,91			
36	90,30	91,67	66	166,69	168,06	96	243,09	244,46			
37	92,85	94,22	67	169,24	170,61	97	245,63	247,00			
38	95,40	96,77	68	171,79	173,16	98	248,18	249,55			
39	97,94	99,31	69	174,33	175,70	99	250,73	252,10			
40	100,49	101,86	70	176,88	178,25	100	253,28	254,67			
41	103,04	104,40	71	179,43	180,8	101	255,82	257,19			
42	105,58	106,95	72	181,98	183,35	102	258,37	259,74			
43	108,13	109,50	73	184,52	185,89	103	260,91	262,28			
44	110,68	112,05	74	187,07	188,44	104	263,46	264,83			
45	113,22	114,59	75	189,61	190,98	105	266,01	267,38			
46	115,77	117,14	76	192,16	193,53	106	268,55	269,92			
47	118,31	119,68	77	194,71	196,08	107	271,10	272,47			

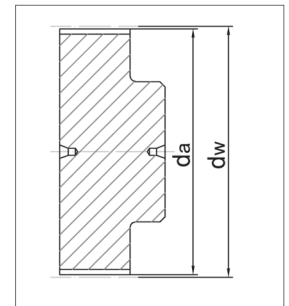

STD 14M

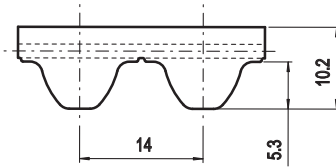

Belt characteristics

- Polyurethane timing belt with involute tooth, high tensile load steel cords and high torque capacity. Produced according to ISO 13050
- Metric pitch 14 mm
- Low noise generation in high speed drives
- Tension cords with increased tensile load for lower elongation
- Superior performance in lifting applications
- The special profile allows smooth running properties

- Width tolerance: $\pm 1,0$ [mm]
- Length tolerance: $\pm 0,5$ [mm/m]
- Thickness tolerance: $\pm 0,4$ [mm]

Technical Data

Belt width b [mm]	Allowable tensile load Type M F_{Tzul} [N]	Allowable tensile load Type V F_{Tzul} [N]	Breaking load Type M F_{Br} [N]	Specific spring rate C_{spez} [N]	Weight [kg/m]
40	12750	6375	48000	3187500	0,50
55	17850	8925	67200	4462500	0,70
85	28050	14025	105600	7012500	1,08
115	39100	19550	147200	9775000	1,48

Other widths are available on request.

Load / Elongation [%]

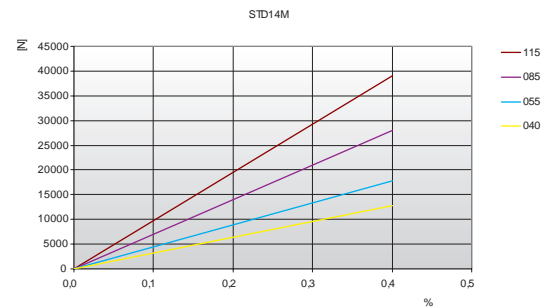

Tooth shear strength

rpm	F_{Uspez} [N/cm]	rpm	F_{Uspez} [N/cm]	rpm	F_{Uspez} [N/cm]	rpm	F_{Uspez} [N/cm]
0	134,00	800	88,80	1900	65,49	4000	43,24
20	131,31	900	85,85	2000	64,01	-	-
40	128,83	1000	83,14	2200	61,23	-	-
60	126,53	1100	80,63	2400	58,68	-	-
80	124,42	1200	78,31	2600	56,30	-	-
100	122,46	1300	76,14	2800	54,09	-	-
200	114,77	1400	74,11	2880	53,24	-	-
300	109,29	1440	73,33	3000	52,01	-	-
400	104,19	1500	72,19	3200	50,06	-	-
500	99,65	1600	70,38	3400	48,22	-	-
600	95,64	1700	68,67	3600	46,48	-	-
700	92,04	1800	67,04	3800	44,82	-	-

Tooth shear strength / rpm

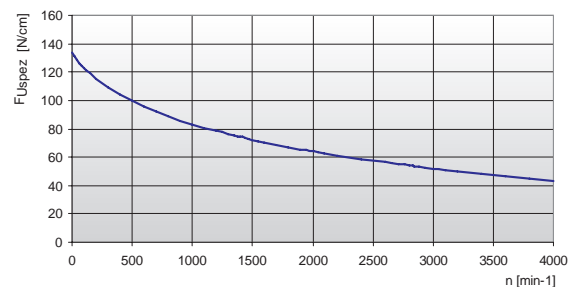



The specific load F_{Uspez} is the maximum load which one single belt tooth 1 cm wide can withstand in all operating conditions. This force is related to the drive rpm. The total load F_u transmissible by the belt in the drive is calculated by:

$$F_u \text{ [N]} = F_{Uspez} \cdot Z_e \cdot b$$

- F_u [N] = peripheral force
- F_{Uspez} [N/cm] = specific load
- Z_e = number of teeth in mesh in the small pulley
- Z_{emax} = max. no of teeth in mesh to be considered for the calculation of the drive
- Z_{emax} = 12 for ELATECH® M
- Z_{emax} = 6 for ELATECH® V
- b [cm] = belt width in cm

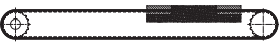
Flexibility

Minimum pulley number of teeth and minimum idler diameter		Type of cord
		STANDARD
Drive without reverse bending 	Timing pulley z_{min}	32
	Flat idler running on belt teeth d_{min}	140 mm
Drive with reverse bending 	Timing pulley z_{min}	32
	Flat idler running on belt back d_{min}	250 mm

Timing pulleys

z	da	dw
28	122,12	124,77
29	126,58	129,22
30	130,99	133,69
31	135,45	138,14
32	139,88	142,59
33	144,35	147,06
34	148,79	151,51
35	153,25	155,96
36	157,68	160,41
37	162,14	164,88
38	166,60	169,34
39	171,02	173,79
40	175,48	178,24
41	179,92	182,71
42	184,37	187,16
43	188,83	191,61
44	193,29	196,08
45	197,75	200,53
46	202,21	204,98
47	206,65	209,43
48	211,11	213,90
49	215,57	218,35
50	220,03	222,80
51	224,49	227,27
52	228,95	231,72
53	233,39	236,18
54	237,85	240,64
55	242,30	245,09
56	246,76	249,55
57	251,22	254,01

z	da	dw
58	255,68	258,46
59	260,14	262,91
60	264,60	267,38
61	269,04	271,83
62	273,50	276,28
63	277,96	280,75
64	282,42	285,20
65	286,88	289,65
66	291,32	294,11
67	295,78	298,56
68	300,24	303,03
69	304,70	307,48
70	309,16	311,93
71	313,61	316,40
72	318,07	320,85
73	322,53	325,30
74	326,98	329,77
75	331,44	334,22
76	335,90	338,67
77	340,34	343,12
78	344,80	347,59
79	349,26	352,04
80	353,72	356,49
81	358,17	360,96
82	362,63	365,41
83	367,09	369,86
84	371,54	374,33
85	376,00	378,78
86	380,46	383,23
87	384,91	387,70

z	da	dw
88	389,37	392,15
89	393,83	396,60
90	398,29	401,07
91	402,73	405,52
92	407,19	409,97
93	411,65	414,44
94	416,10	418,89
95	420,56	423,35
96	425,02	427,80
97	429,48	432,25
98	433,94	436,72
99	438,38	441,17
100	442,84	445,62
101	447,30	450,09
102	451,76	454,54
103	456,21	459,00
104	460,67	463,45
105	465,13	467,90
106	469,58	472,37
107	474,03	476,82
108	478,49	481,28
109	482,95	485,74
110	487,41	490,19
111	491,87	494,64
112	496,32	499,10
113	500,78	503,55
114	505,23	508,02
116	514,14	516,93
117	518,60	521,38
118	523,06	525,83

z	da	dw
119	527,51	530,30
120	531,97	534,75

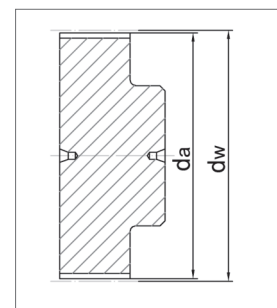

EAGLE 5M

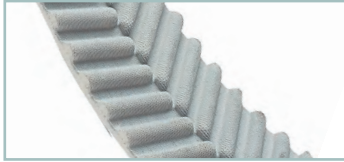
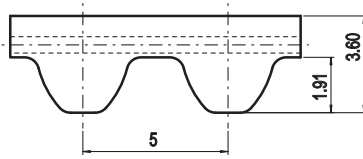

Belt characteristics

- Polyurethane timing belt with helical offset tooth, high tensile load steel cords and high torque capacity
- **Self tracking no need of pulley flanges**
- Metric pitch 5 mm
- **Extremely reduced noise generation**
- Offers excellent operational reliability in linear positioning and medium power transmission applications
- The special profile allows most compact drive

- Width tolerance: $\pm 0,5$ [mm]
- Length tolerance: $\pm 0,5$ [mm/m]
- Thickness tolerance: $\pm 0,2$ [mm]

Technical Data

Belt width b [mm]	Allowable tensile load Type M F_{Tzul} [N]	Allowable tensile load Type V F_{Tzul} [N]	Breaking load Type M F_{Br} [N]	Specific spring rate C_{spez} [N]	Weight [kg/m]
12,5	1150	575	4200	287500	0,06
25	2530	1265	9240	632500	0,12

Other widths are available on request.

Load / Elongation [%]

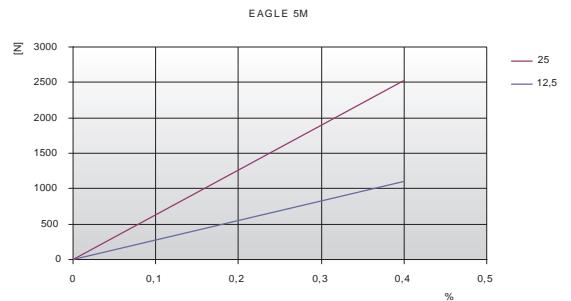

Tooth shear strength

rpm	F_{Uspez} [N/cm]	rpm	F_{Uspez} [N/cm]	rpm	F_{Uspez} [N/cm]	rpm	F_{Uspez} [N/cm]
0	37,80	900	28,61	2200	23,30	5500	16,95
20	37,25	1000	28,05	2400	22,72	6000	16,32
40	36,75	1100	27,52	2600	22,19	6500	15,74
60	36,30	1200	27,03	2800	21,69	7000	15,19
80	35,89	1300	26,56	2880	21,50	7500	14,68
100	35,52	1400	26,13	3000	21,23	8000	14,20
200	34,13	1440	25,96	3200	20,78	8500	13,75
300	32,87	1500	25,71	3400	20,37	9000	13,33
400	32,10	1600	25,32	3600	19,97	9500	12,92
500	31,31	1700	24,94	3800	19,59	10000	12,53
600	30,56	1800	24,58	4000	19,23	-	-
700	29,86	1900	24,24	4500	18,40	-	-
800	29,21	2000	23,91	5000	17,64	-	-

Tooth shear strength / rpm

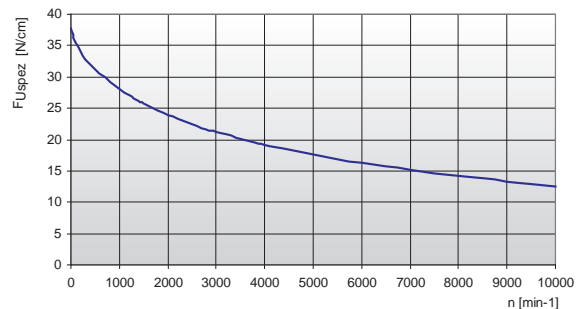

The specific load F_{Uspez} is the maximum load which one single belt tooth 1 cm wide can withstand in all operating conditions. This force is related to the drive rpm.

The total load F_u transmissible by the belt in the drive is calculated by:

$$F_u \text{ [N]} = F_{Uspez} \cdot Z_e \cdot b$$

- F_u [N] = peripheral force
- F_{Uspez} [N/cm] = specific load
- Z_e = number of teeth in mesh in the small pulley
- Z_{emax} = max. no of teeth in mesh to be considered for the calculation of the drive
- Z_{emax} = 12 for ELATECH® M
- Z_{emax} = 6 for ELATECH® V
- b [cm] = belt width in cm

Flexibility

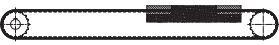
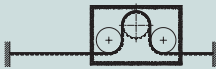
Minimum pulley number of teeth and minimum idler diameter		Type of cord
		STANDARD
Drive without reverse bending 	Timing pulley z_{min}	16
	Flat idler running on belt teeth d_{min}	30 mm
Drive with reverse bending 	Timing pulley z_{min}	25
	Flat idler running on belt back d_{min}	60 mm

Timing pulleys

z	da	dw	z	da	dw	z	da	dw	z	da	dw
10	14,95	15,91	40	62,70	63,66	70	110,45	111,41	100	158,19	159,15
11	16,54	17,50	41	64,30	65,26	71	112,04	113,00	101	159,79	160,75
12	18,14	19,10	42	65,89	66,85	72	113,63	114,59	102	161,38	162,34
13	19,73	20,69	43	67,48	68,44	73	115,23	116,19	103	162,99	163,95
14	21,32	22,28	44	69,07	70,03	74	116,82	117,78	104	164,56	165,52
15	22,91	23,87	45	70,66	71,62	75	118,41	119,37	105	166,15	167,11
16	24,51	25,47	46	72,25	73,21	76	120,00	120,96	106	167,74	168,70
17	26,10	27,06	47	73,84	74,80	77	121,59	122,55	107	169,34	170,30
18	27,69	28,65	48	75,43	76,39	78	123,18	124,14	108	170,93	171,89
19	29,27	30,23	49	77,03	77,99	79	124,77	125,73	109	172,52	173,48
20	30,87	31,83	50	78,62	79,58	80	126,36	127,32	110	174,1	175,06
21	32,46	33,42	51	80,21	81,17	81	127,95	128,91	111	175,7	176,66
22	34,05	35,01	52	81,80	82,76	82	129,54	130,50	112	177,29	178,25
23	35,65	36,61	53	83,39	84,35	83	131,14	132,10	113	178,88	179,84
24	37,23	38,19	54	84,99	85,95	84	132,73	133,69	114	180,47	181,43
25	38,83	39,79	55	86,58	87,54	85	134,32	135,28	115	182,06	183,02
26	40,42	41,38	56	88,17	89,13	86	135,91	136,87	116	183,65	184,61
27	42,01	42,97	57	89,76	90,72	87	137,51	138,47	117	185,25	186,21
28	43,60	44,56	58	91,35	92,31	88	139,09	140,05	118	186,84	187,8
29	45,19	46,15	59	92,94	93,90	89	140,69	141,65	119	188,43	189,39
30	46,79	47,75	60	94,53	95,49	90	142,28	143,24	120	190,02	190,98
31	48,38	49,34	61	96,13	97,09	91	143,87	144,83			
32	49,97	50,93	62	97,72	98,68	92	145,46	146,42			
33	51,56	52,52	63	99,31	100,27	93	147,05	148,01			
34	53,15	54,11	64	100,90	101,86	94	148,64	149,60			
35	54,75	55,71	65	102,49	103,45	95	150,24	151,20			
36	56,34	57,30	66	104,08	105,04	96	151,83	152,71			
37	57,93	58,89	67	105,67	106,63	97	153,42	154,38			
38	59,52	60,48	68	107,27	108,23	98	155,01	155,97			
39	61,11	62,07	69	108,86	109,82	99	156,60	157,56			

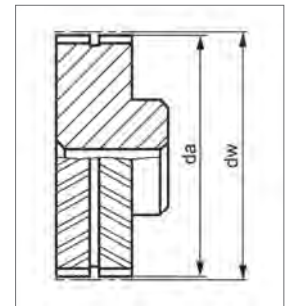

EAGLE 8M

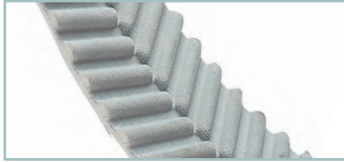
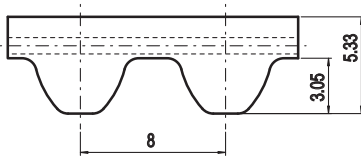

Belt characteristics

- Polyurethane timing belt with helical offset tooth, high tensile load steel cords and high torque capacity
- **Self tracking no need of pulley flanges**
- Metric pitch 8 mm
- **Extremely reduced noise generation**
- Offers excellent operational reliability in linear positioning and medium power transmission applications
- The special profile allows most compact drive

- Width tolerance: $\pm 0,8$ [mm]
- Length tolerance: $\pm 0,8$ [mm/m]
- Thickness tolerance: $\pm 0,3$ [mm]

Technical Data

Belt width b [mm]	Allowable tensile load Type M F_{Tzul} [N]	Allowable tensile load Type V F_{Tzul} [N]	Breaking load Type M F_{Br} [N]	Specific spring rate C_{spez} [N]	Weight [kg/m]
16	2450	1200	9500	612500	0,085
25	4170	2100	16150	1042500	0,145
32	5390	2700	20900	1347500	0,180
50	8580	4300	33250	2145000	0,300

Other widths are available on request.

Load / Elongation [%]

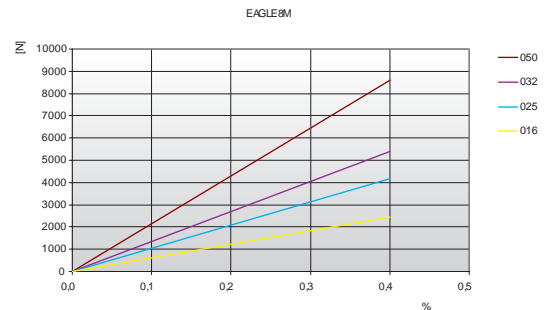

Tooth shear strength

rpm	F_{Uspez} [N/cm]	rpm	F_{Uspez} [N/cm]	rpm	F_{Uspez} [N/cm]	rpm	F_{Uspez} [N/cm]
0	85,00	800	59,66	1900	46,95	4500	32,75
20	83,78	900	58,05	2000	46,14	5000	30,94
40	82,62	1000	56,58	2200	44,62	5500	29,30
60	81,49	1100	55,22	2400	43,22	6000	27,79
80	80,42	1200	53,95	2600	41,91	6500	26,40
100	79,38	1300	52,77	2800	40,70	7000	25,11
200	74,78	1400	51,66	3000	39,56	7500	23,90
300	71,01	1440	51,23	3200	38,49	8000	22,77
400	67,93	1500	50,61	3400	37,48	8500	21,70
500	65,52	1600	49,62	3600	36,52	9000	20,69
600	63,36	1700	48,69	3800	35,61	9500	19,73
700	61,42	1800	47,80	4000	34,75	10000	18,82

Tooth shear strength / rpm

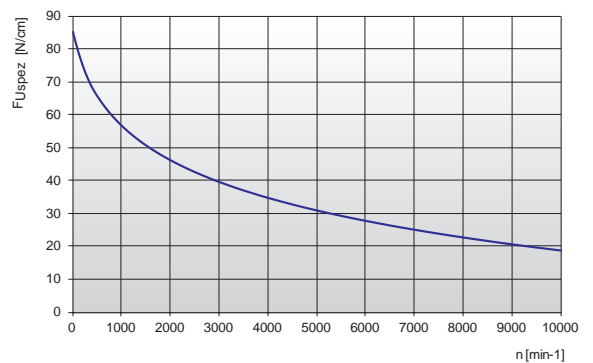

The specific load F_{Uspez} is the maximum load which one single belt tooth 1 cm wide can withstand in all operating conditions. This force is related to the drive rpm.

The total load F_u transmissible by the belt in the drive is calculated by:



$$F_u [N] = F_{Uspez} \cdot Z_e \cdot b$$

- F_u [N] = peripheral force
- F_{Uspez} [N/cm] = specific load
- Z_e = number of teeth in mesh in the small pulley
- Z_{emax} = max. no of teeth in mesh to be considered for the calculation of the drive
- Z_{emax} = 12 for ELATECH® M
- Z_{emax} = 6 for ELATECH® V
- b [cm] = belt width in cm

Specialties

Belt width b [mm]	ARAMID CORD		STAINLESS STEEL		HPL High Performance	
	F_{Tzul} [N] M type	F_{Br} [N]	F_{Tzul} [N] M type	F_{Br} [N]	F_{Tzul} [N] M type	F_{Br} [N]
16	1800	7500	1800	7500	3840	14000
25	3060	12750	3060	12750	6720	24500
32	3960	16500	3960	16500	8640	31500
50	6300	26250	6300	26250	14400	52500

Flexibility

Minimum pulley number of teeth and minimum idler diameter		Type of cord		
		STANDARD	STAINLESS	HPL
Drive without reverse bending 	Timing pulley z_{min}	20	24	30
	Flat idler running on belt teeth d_{min}	50 mm	70 mm	80 mm
Drive with reverse bending 	Timing pulley z_{min}	30	40	30
	Flat idler running on belt back d_{min}	120 mm	120 mm	150 mm

Timing pulleys

z	da	dw	z	da	dw	z	da	dw	z	da	dw
18	44,46	45,83	48	120,86	122,23	78	197,25	198,62	108	273,64	275,01
19	47,01	48,38	49	123,40	124,77	79	199,80	201,17	109	276,19	277,56
20	49,56	50,93	50	125,95	127,32	80	202,35	203,72	110	278,74	280,11
21	52,10	53,47	51	128,50	129,87	81	204,89	206,26	111	281,29	282,66
22	54,65	56,02	52	131,05	132,41	82	207,44	208,81	112	283,84	285,21
23	57,20	58,57	53	133,59	134,96	83	209,98	211,35	113	286,38	287,75
24	59,75	61,12	54	136,14	137,51	84	212,53	213,90	114	288,93	290,30
25	62,29	63,66	55	138,68	140,05	85	215,08	216,45	115	291,47	292,84
26	64,84	66,21	56	141,23	142,60	86	217,63	219,00	116	294,02	295,39
27	67,38	68,75	57	143,78	145,15	87	220,17	221,54	117	296,57	297,94
28	70,08	71,30	58	146,32	147,69	88	222,72	224,09	118	299,11	300,48
29	72,59	73,84	59	148,87	150,24	89	225,26	226,63	119	301,66	303,03
30	75,13	76,39	60	151,42	152,79	90	227,81	229,18	120	304,2	305,57
31	77,65	78,94	61	153,96	155,33	91	230,35	231,72			
32	80,16	81,49	62	156,52	157,89	92	232,90	234,27			
33	82,68	84,03	63	159,06	160,43	93	235,45	236,82			
34	85,21	86,58	64	161,6	162,97	94	238,00	239,37			
35	87,76	89,12	65	164,15	165,52	95	240,54	241,91			
36	90,30	91,67	66	166,69	168,06	96	243,09	244,46			
37	92,85	94,22	67	169,24	170,61	97	245,63	247,00			
38	95,40	96,77	68	171,79	173,16	98	248,18	249,55			
39	97,94	99,31	69	174,33	175,70	99	250,73	252,10			
40	100,49	101,86	70	176,88	178,25	100	253,28	254,67			
41	103,04	104,40	71	179,43	180,80	101	255,82	257,19			
42	105,58	106,95	72	181,98	183,35	102	258,37	259,74			
43	108,13	109,50	73	184,52	185,89	103	260,91	262,28			
44	110,68	112,05	74	187,07	188,44	104	263,46	264,83			
45	113,22	114,59	75	189,61	190,98	105	266,01	267,38			
46	115,77	117,14	76	192,16	193,53	106	268,55	269,92			
47	118,31	119,68	77	194,71	196,08	107	271,1	272,47			

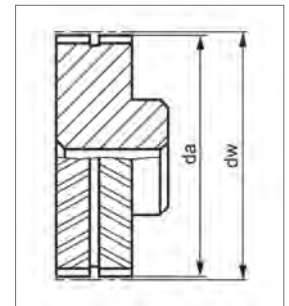

EAGLE 10M

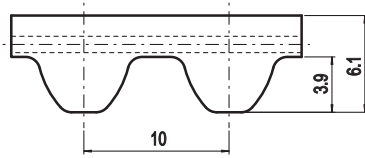

Belt characteristics

- Polyurethane timing belt with helical offset tooth, high tensile load steel cords and high torque capacity
- **Self tracking no need of pulley flanges**
- Metric pitch 10 mm
- **Extremely reduced noise generation**
- Offers excellent operational reliability in linear positioning and medium power transmission applications
- The special profile allows most compact drive

- Width tolerance: $\pm 0,8$ [mm]
- Length tolerance: $\pm 0,8$ [mm/m]
- Thickness tolerance: $\pm 0,3$ [mm]

Technical Data

Belt width b [mm]	Allowable tensile load Type M F_{Tzul} [N]	Breaking load Type M F_{Br} [N]	Specific spring rate C_{spez} [N]	Weight [kg/m]
25	6720	24500	1680000	0,18
32	8640	31500	2160000	0,23
50	14400	52500	3600000	0,37
75	21120	77000	5280000	0,54
100	28800	105000	7200000	0,74

Other widths are available on request.

Load / Elongation [%]

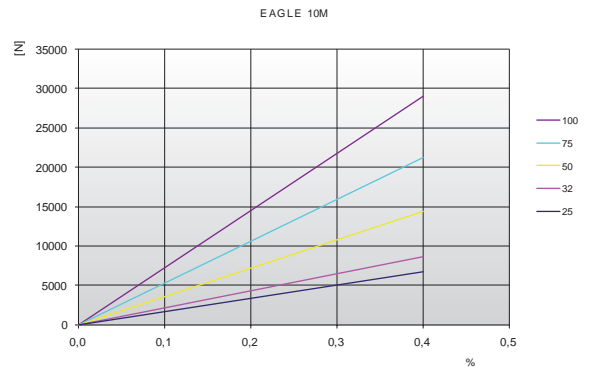

Tooth shear strength

rpm	F_{Uspez} [N/cm]	rpm	F_{Uspez} [N/cm]	rpm	F_{Uspez} [N/cm]	rpm	F_{Uspez} [N/cm]
0	93,50	800	64,43	1900	50,70	4500	35,37
20	92,03	900	62,70	2000	49,83	5000	33,42
40	90,63	1000	61,11	2200	48,19	5500	31,65
60	89,28	1100	59,63	2400	46,67	6000	30,02
80	88,00	1200	58,27	2600	45,27	6500	28,51
100	86,77	1300	56,99	2800	43,96	7000	27,12
200	81,36	1400	55,79	3000	42,73	7500	25,81
300	77,02	1440	55,33	3200	41,57	8000	24,59
400	73,54	1500	54,66	3400	40,48	8500	23,43
500	70,76	1600	53,59	3600	39,45	9000	22,34
600	68,43	1700	52,58	3800	38,46	9500	21,31
700	66,33	1800	51,62	4000	37,53	10000	20,33

Tooth shear strength / rpm

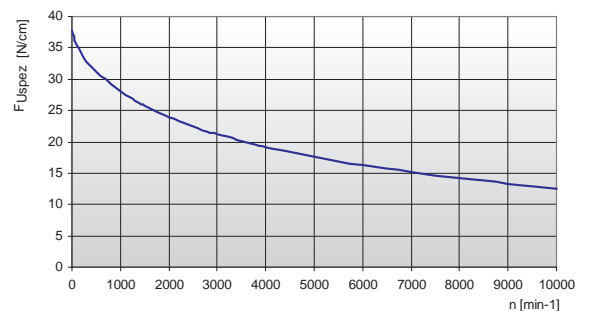

The specific load F_{Uspez} is the maximum load which one single belt tooth 1 cm wide can withstand in all operating conditions.



This force is related to the drive rpm.

The total load F_u transmissible by the belt in the drive is calculated by:

$$F_u \text{ [N]} = F_{Uspez} \cdot Z_e \cdot b$$

- F_u [N] = peripheral force
- F_{Uspez} [N/cm] = specific load
- Z_e = number of teeth in mesh in the small pulley
- Z_{emax} = max. no of teeth in mesh to be considered for the calculation of the drive
- Z_{emax} = 12 for ELATECH® M
- Z_{emax} = 6 for ELATECH® V
- b [cm] = belt width in cm

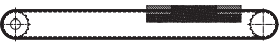
Flexibility

Minimum pulley number of teeth and minimum idler diameter		Type of cord
		STANDARD
Drive without reverse bending 	Timing pulley z_{min}	25
	Flat idler running on belt teeth d_{min}	80 mm
Drive with reverse bending 	Timing pulley z_{min}	25
	Flat idler running on belt back d_{min}	150 mm

Timing pulleys

z	da	dw	z	da	dw	z	da	dw	z	da	dw
18	55,29	57,29	48	150,78	152,78	78	246,24	248,24	108	341,76	343,76
19	58,48	60,48	49	153,97	155,97	79	249,46	251,46	109	344,95	346,95
20	61,66	63,66	50	157,15	159,15	80	252,64	254,64	110	348,13	350,13
21	64,84	66,84	51	160,33	162,33	81	255,82	257,82	111	351,31	353,31
22	68,03	70,03	52	163,52	165,52	82	259,00	261,00	112	354,50	356,50
23	71,20	73,20	53	166,70	168,70	83	262,19	264,19	113	357,68	359,68
24	74,39	76,39	54	169,88	171,88	84	265,37	267,37	114	360,86	362,86
25	77,58	79,58	55	173,06	175,06	85	268,52	270,52	115	364,04	366,04
26	80,76	82,76	56	176,25	178,25	86	271,74	273,74	116	367,23	369,23
27	83,95	85,95	57	179,43	181,43	87	274,92	276,92	117	370,41	372,41
28	87,12	89,12	58	182,61	184,61	88	278,10	280,10	118	373,59	375,59
29	90,21	92,21	59	185,80	187,80	89	281,28	283,28	119	376,78	378,78
30	93,49	95,49	60	188,98	190,98	90	284,47	286,47	120	379,96	381,96
31	96,67	98,67	61	192,16	194,16	91	287,65	289,65			
32	99,86	101,86	62	195,35	197,35	92	290,84	292,84			
33	103,04	105,04	63	198,53	200,53	93	294,02	296,02			
34	106,19	108,19	64	201,71	203,71	94	297,20	299,20			
35	109,41	111,41	65	204,90	206,90	95	300,39	302,39			
36	112,59	114,59	66	208,08	210,08	96	303,57	305,57			
37	115,77	117,77	67	211,26	213,26	97	306,75	308,75			
38	118,95	120,95	68	214,44	216,44	98	309,93	311,93			
39	122,14	124,14	69	217,63	219,63	99	313,12	315,12			
40	125,32	127,32	70	220,81	222,81	100	316,30	318,30			
41	128,50	130,50	71	223,99	225,99	101	319,48	321,48			
42	131,69	133,69	72	227,18	229,18	102	322,66	324,66			
43	134,87	136,87	73	230,33	232,33	103	325,85	327,85			
44	138,05	140,05	74	233,54	235,54	104	329,03	331,03			
45	141,24	143,24	75	236,72	238,72	105	332,21	334,21			
46	144,42	146,42	76	239,94	241,94	106	335,40	337,40			
47	147,60	149,60	77	243,09	245,09	107	338,58	340,58			

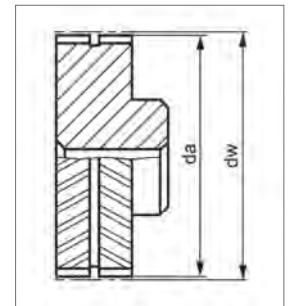

EAGLE 14M

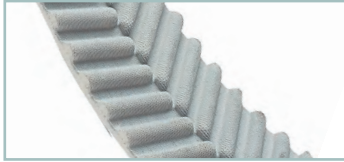
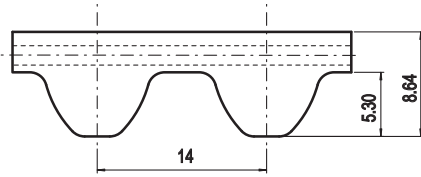

Belt characteristics

- Polyurethane timing belt with helical offset tooth, high tensile load steel cords and high torque capacity.
- **Self tracking no need of pulley flanges**
- Metric pitch 14 mm
- **Extremely reduced noise generation**
- Offers excellent operational reliability in linear positioning, heavy power transmission and lifting applications
- The special profile allows most compact drive

- Width tolerance: $\pm 1,2$ [mm]
- Length tolerance: $\pm 0,8$ [mm/m]
- Thickness tolerance: $\pm 0,4$ [mm]

Technical Data

Belt width b [mm]	Allowable tensile load Type M F_{Tzul} [N]	Allowable tensile load Type V F_{Tzul} [N]	Breaking load Type M F_{Br} [N]	Specific spring rate C_{spez} [N]	Weight [kg/m]
35	11050	4650	41600	2762500	0,400
52	17000	7350	64000	4250000	0,600
70	22950	9800	86400	5737500	0,800
105	34850	16300	131200	8712500	1,200

Load / Elongation [%]

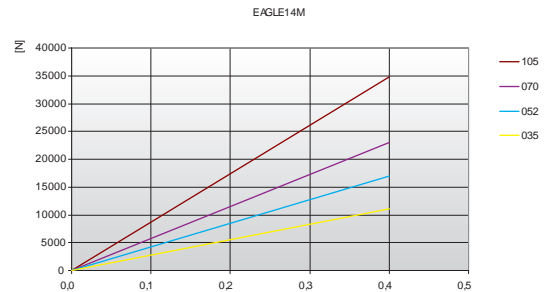

Tooth shear strength

rpm	F_{Uspez} [N/cm]	rpm	F_{Uspez} [N/cm]	rpm	F_{Uspez} [N/cm]	rpm	F_{Uspez} [N/cm]
0	160,00	800	103,35	1900	73,99	4000	46,21
20	157,00	900	99,60	2000	72,13	-	-
40	154,22	1000	96,17	2200	68,66	-	-
60	151,64	1100	93,01	2400	65,46	-	-
80	149,24	1200	90,08	2600	62,50	-	-
100	147,01	1300	87,35	2800	59,73	-	-
200	138,04	1400	84,80	2880	58,68	-	-
300	129,87	1440	83,82	3000	57,15	-	-
400	123,12	1500	82,39	3200	54,71	-	-
500	117,24	1600	80,12	3400	52,42	-	-
600	112,07	1700	77,97	3600	50,24	-	-
700	107,48	1800	75,93	3800	48,18	-	-

Tooth shear strength / rpm

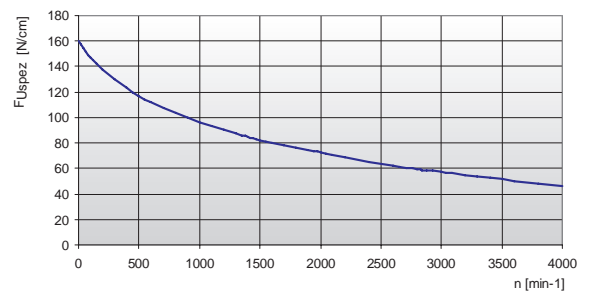

The specific load F_{Uspez} is the maximum load which one single belt tooth 1 cm wide can withstand in all operating conditions. This force is related to the drive rpm. The total load F_u transmissible by the belt in the drive is calculated by:



$$F_u \text{ [N]} = F_{Uspez} \cdot Z_e \cdot b$$

- F_u [N] = peripheral force
- F_{Uspez} [N/cm] = specific load
- Z_e = number of teeth in mesh in the small pulley
- Z_{emax} = max. no of teeth in mesh to be considered for the calculation of the drive
- Z_{emax} = 12 for ELATECH® M
- Z_{emax} = 6 for ELATECH® V
- b [cm] = belt width in cm

Specialties

Belt width b [mm]	HPL High Performance	
	F _{Tzul} [N] M type	F _{Br} [N]
35	12100	49500
52	17600	72000
70	24200	99000
105	37400	153000

Flexibility

Minimum pulley number of teeth and minimum idler diameter		Type of cord	
		STANDARD	HPL
Drive without reverse bending 	Timing pulley z _{min}	32	32
	Flat idler running on belt teeth d _{min}	140 mm	140 mm
Drive with reverse bending 	Timing pulley z _{min}	32	32
	Flat idler running on belt back d _{min}	200 mm	200 mm

Timing pulleys

z	da	dw	z	da	dw	z	da	dw	z	da	dw
28	122,12	124,77	58	255,68	258,46	88	389,37	392,15	119	527,51	530,30
29	126,58	129,22	59	260,14	262,91	89	393,83	396,60	120	531,97	534,75
30	130,99	133,69	60	264,60	267,38	90	398,29	401,07			
31	135,45	138,14	61	269,04	271,83	91	402,73	405,52			
32	139,88	142,59	62	273,50	276,28	92	407,19	409,97			
33	144,35	147,06	63	277,96	280,75	93	411,65	414,44			
34	148,79	151,51	64	282,42	285,20	94	416,10	418,89			
35	153,25	155,96	65	286,88	289,65	95	420,56	423,35			
36	157,68	160,41	66	291,32	294,11	96	425,02	427,80			
37	162,14	164,88	67	295,78	298,56	97	429,48	432,25			
38	166,60	169,34	68	300,24	303,03	98	433,94	436,72			
39	171,02	173,79	69	304,70	307,48	99	438,38	441,17			
40	175,48	178,24	70	309,16	311,93	100	442,84	445,62			
41	179,92	182,71	71	313,61	316,40	101	447,30	450,09			
42	184,37	187,16	72	318,07	320,85	102	451,76	454,54			
43	188,83	191,61	73	322,53	325,30	103	456,21	459,00			
44	193,29	196,08	74	326,98	329,77	104	460,67	463,45			
45	197,75	200,53	75	331,44	334,22	105	465,13	467,90			
46	202,21	204,98	76	335,90	338,67	106	469,58	472,37			
47	206,65	209,43	77	340,34	343,12	107	474,03	476,82			
48	211,11	213,90	78	344,80	347,59	108	478,49	481,28			
49	215,57	218,35	79	349,26	352,04	109	482,95	485,74			
50	220,03	222,80	80	353,72	356,49	110	487,41	490,19			
51	224,49	227,27	81	358,17	360,96	111	491,87	494,64			
52	228,95	231,72	82	362,63	365,41	112	496,32	499,10			
53	233,39	236,18	83	367,09	369,86	113	500,78	503,55			
54	237,85	240,64	84	371,54	374,33	114	505,23	508,02			
55	242,30	245,09	85	376,00	378,78	116	514,14	516,93			
56	246,76	249,55	86	380,46	383,23	117	518,60	521,38			
57	251,22	254,01	87	384,91	387,70	118	523,06	525,83			

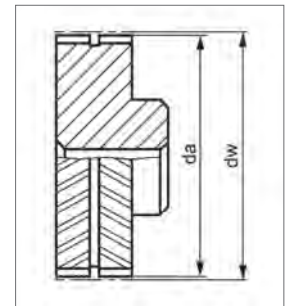

TK 5 K6

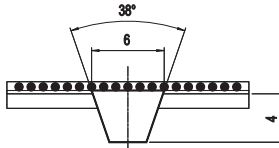
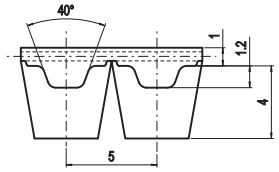

Belt characteristics

- Polyurethane self tracking timing belt with steel tension cords
- Profile T5 with central guide - K6 x 4 mm
- Central guide height 4,0 mm
- Allow to use pulleys without flanges
- The central guide is notched in order to maximize belt flexibility
- Ideal for conveying applications where a side load is generated by loading/unloading transferring a product

- Width tolerance: $\pm 0,5$ [mm]
- Length tolerance: $\pm 0,5$ [mm/m]

Technical Data

Belt width b [mm]	Allowable tensile load Type M F_{Tzul} [N]	Allowable tensile load Type V F_{Tzul} [N]	Breaking load Type M F_{Br} [N]	Specific spring rate C_{spez} [N]	Weight [kg/m]
32	1150	575	4500	287500	0,080
50	1860	930	7250	465000	0,130
75	2820	1410	11000	705000	0,200
100	3780	1890	14750	945000	0,260

Load / Elongation [%]

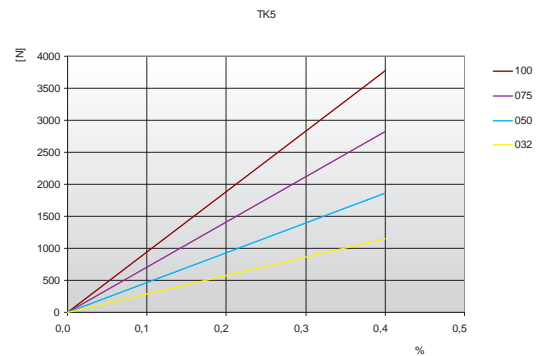

Specialties

Belt width b [mm]	ARAMID CORD	
	F_{Tzul} [N] M type	F_{Br} [N]
32	2520	10080
50	4060	16240
75	6160	24640
100	8260	33040

Pulley profile

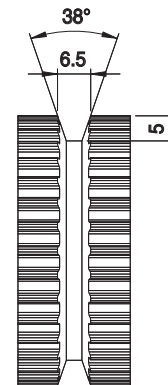

Flexibility

Minimum pulley number of teeth and minimum idler diameter		Type of cord
		STANDARD
Drive without reverse bending 	Timing pulley z_{min}	14
	Flat idler running on belt teeth d_{min}	40 mm
Drive with reverse bending 	Timing pulley z_{min}	15
	Flat idler running on belt back d_{min}	40 mm

TK 10 K13 - K6

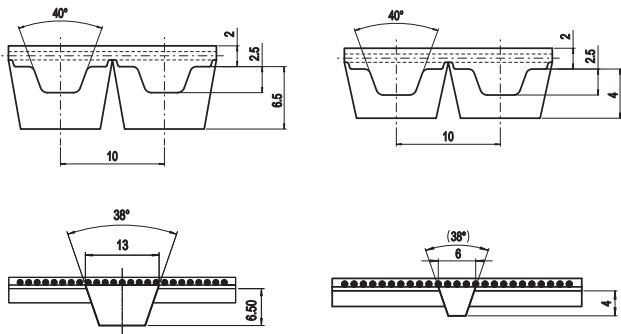
K13
K6

Belt characteristics

- Polyurethane self track timing belt with steel tension cords
- Profile T10 with central guide - K13 x 6,5
- Profile T10 with central guide - K6 x 4,0
- Central guide height 6,5 mm
- Allow to use pulleys without flanges
- The central guide is notched in order to maximize belt flexibility
- Ideal for conveying applications where a side load is generated by loading/unloading transferring a product

- Width tolerance: $\pm 0,5$ [mm]
- Length tolerance: $\pm 0,5$ [mm/m]

Technical Data

Belt width b [mm]	Allowable tensile load Type M F_{Tzul} [N]	Allowable tensile load Type V F_{Tzul} [N]	Breaking load Type M F_{Br} [N]	Specific spring rate C_{spez} [N]	Weight [kg/m]
32	3450	1725	12600	862500	0,220
50	5520	2760	20160	1380000	0,300
75	8400	4200	30660	2100000	0,410
100	11270	5635	41160	2817500	0,530
150	17020	8510	62160	4255000	0,850

150 mm width available only in K6 execution.

Load / Elongation [%]

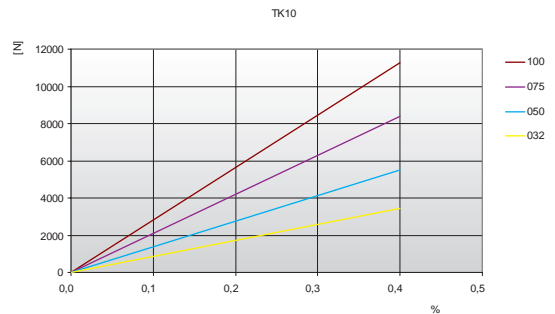

Specialties

Belt width b [mm]	ARAMID CORD	
	F_{Tzul} [N] M type	F_{Br} [N]
32	3300	13500
50	8280	21600
75	8030	32850
100	10780	44100
150	16280	66600

Pulley profile

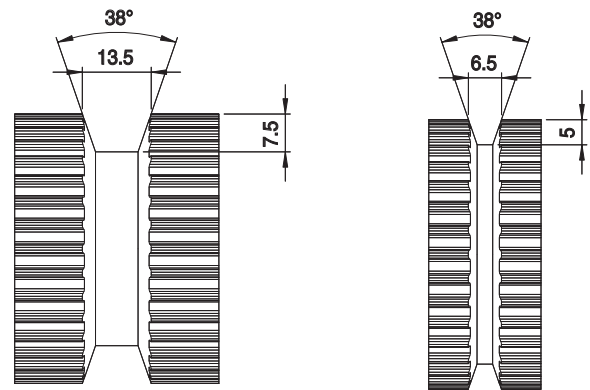
K13
K6

Flexibility

Minimum pulley number of teeth and minimum idler diameter		Guide	
		K6	K13
	Timing pulley z_{min}	14	16
	Flat idler running on belt teeth d_{min}	60 mm	80 mm
	Timing pulley z_{min}	20	20
	Flat idler running on belt back d_{min}	60 mm	60 mm

ATK 5 K6

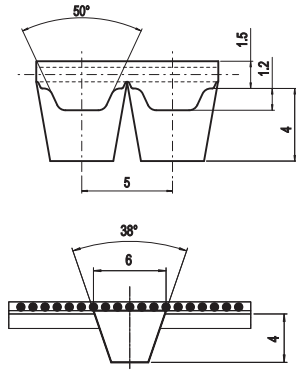

Belt characteristics

- Polyurethane self track timing belt with steel tension cords
 - Profile AT5 with central guide - K6 x 4 mm
 - Central guide height 4,0 mm
 - Allow to use pulleys without flanges
 - The central guide is notched in order to maximize belt flexibility
 - Ideal for conveying applications where a side load is generated by loading/unloading transferring a product
- Width tolerance: $\pm 0,5$ [mm]
 - Length tolerance: $\pm 0,5$ [mm/m]

- Width tolerance: $\pm 0,5$ [mm]
- Length tolerance: $\pm 0,5$ [mm/m]

Technical Data

Belt width b [mm]	Allowable tensile load Type M F_{Tzul} [N]	Allowable tensile load Type V F_{Tzul} [N]	Breaking load Type M F_{Br} [N]	Specific spring rate C_{spez} [N]	Weight [kg/m]
32	3450	1725	12600	862500	0,11
50	5520	2760	20160	1380000	0,19
75	8400	4200	30660	2100000	0,29
100	11270	5635	41160	2817500	0,38

Load / Elongation [%]

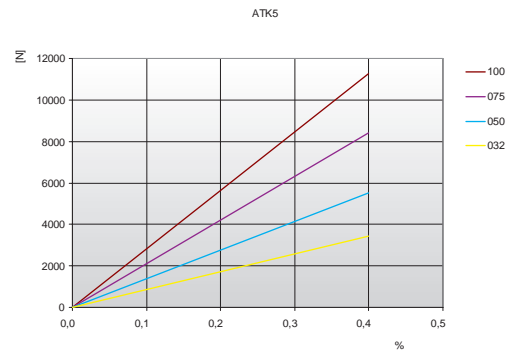

Specialties

Belt width b [mm]	ARAMID CORD	
	F_{Tzul} [N] M type	F_{Br} [N]
32	3300	13500
50	8280	21600
75	8030	32850
100	10780	44100

Pulley profile

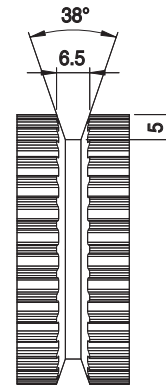

Flexibility

Minimum pulley number of teeth and minimum idler diameter		Type of cord
		STANDARD
Drive without reverse bending 	Timing pulley z_{min}	25
	Flat idler running on belt teeth d_{min}	60 mm
Drive with reverse bending 	Timing pulley z_{min}	25
	Flat idler running on belt back d_{min}	80 mm

ATK 10 K13 - K6

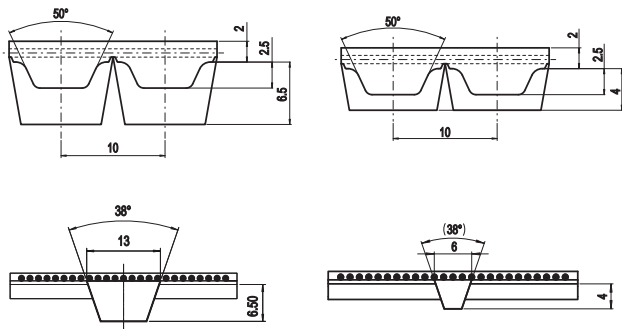
K13
K6

Belt characteristics

- Polyurethane self track timing belt with steel tension cords
- Profile AT10 with central guide - K13 x 6,5 mm
- Profile AT10 with central guide - K6 x 4 mm
- Central guide height 6,5 mm
- Allow to use pulleys without flanges
- The central guide is notched in order to maximize belt flexibility
- Ideal for conveying applications where a side load is generated by loading/unloading transferring a product

- Width tolerance: $\pm 0,5$ [mm]
- Length tolerance: $\pm 0,5$ [mm/m]

Technical Data

Belt width b [mm]	Allowable tensile load Type M F_{Tzul} [N]	Allowable tensile load Type V F_{Tzul} [N]	Breaking load Type M F_{Br} [N]	Specific spring rate C_{spez} [N]	Weight [kg/m]
32	5390	2695	20900	1347500	0,27
50	8580	4290	33250	2145000	0,36
75	12990	6495	50350	3247500	0,50
100	17400	8700	67450	4350000	0,72
150	25970	13110	100700	6492500	1,08

150 mm width available only in K13 execution.

Load / Elongation [%]

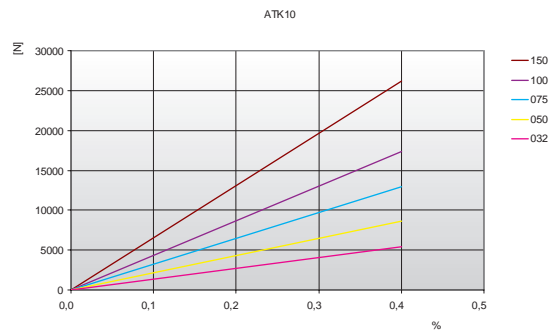

Specialties

Belt width b [mm]	ARAMID CORD	
	F_{Tzul} [N] M type	F_{Br} [N]
32	4180	17380
50	6650	27650
75	10070	41870
100	13490	56090
150	20330	84530

Pulley profile

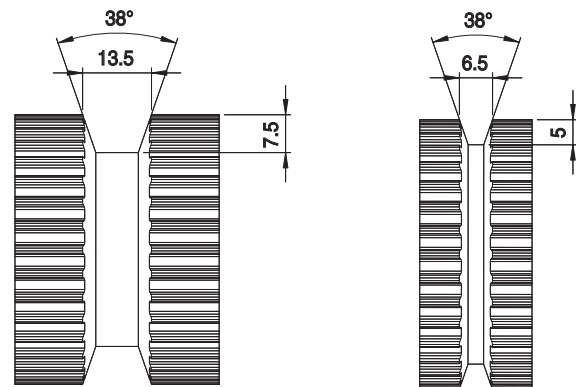

K13
K6

Flexibility

Minimum pulley number of teeth and minimum idler diameter		Guide	
		K6	K13
	Timing pulley z_{min}	15	17
	Flat idler running on belt teeth d_{min}	50 mm	50 mm
	Timing pulley z_{min}	25	25
	Flat idler running on belt back d_{min}	120 mm	120 mm

T 10

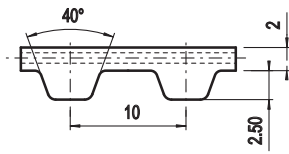
TOTAL PROTECTION



Belt characteristics

- Polyurethane timing belt with steel tension cords
- Trapezoidal tooth profile according to DIN 7721 T1
- Metric pitch 10 mm
- **TP (Total Protection) belt. The absence of tooth gap makes the belt cords protected against corrosion**
- **Widely used in applications with corrosive environment, high humidity**
- Light blue color available on request

- Width tolerance: $\pm 0,5$ [mm]
- Length tolerance: $\pm 0,5$ [mm/m]
- Thickness tolerance: $\pm 0,2$ [mm]

Technical Data

Belt width b [mm]	Allowable tensile load Type M F_{Tzul} [N]	Allowable tensile load Type V F_{Tzul} [N]	Breaking load Type M F_{Br} [N]	Specific spring rate C_{spez} [N]	Weight [kg/m]
10	920	460	3360	230000	0,05
16	1610	805	5880	402500	0,07
25	2650	1325	9660	662500	0,11
32	3450	1725	12600	862500	0,15
50	5520	2760	20160	1380000	0,23
75	8400	4200	30660	2100000	0,34
100	11270	5635	41160	2817500	0,45

Other widths are available on request.

Load / Elongation [%]

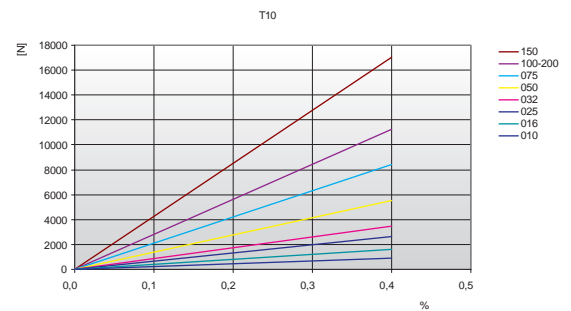

Tooth shear strength

rpm	F_{Uspez} [N/cm]	rpm	F_{Uspez} [N/cm]	rpm	F_{Uspez} [N/cm]	rpm	F_{Uspez} [N/cm]
0	51,80	800	33,34	1900	26,53	4500	19,40
20	50,32	900	32,44	2000	26,12	5000	18,51
40	49,04	1000	31,63	2200	25,34	5500	17,70
60	47,92	1100	30,89	2400	24,63	6000	16,97
80	46,95	1200	30,21	2600	23,97	6500	16,29
100	46,11	1300	29,58	2800	23,36	7000	15,66
200	42,75	1400	28,99	3000	22,78	7500	15,07
300	40,28	1440	28,76	3200	22,25	8000	14,52
400	38,36	1500	28,44	3400	21,74	8500	14,00
500	36,80	1600	27,92	3600	21,27	9000	13,51
600	35,49	1700	27,43	3800	20,81	9500	13,05
700	34,35	1800	26,97	4000	20,39	10000	12,61

Tooth shear strength / rpm

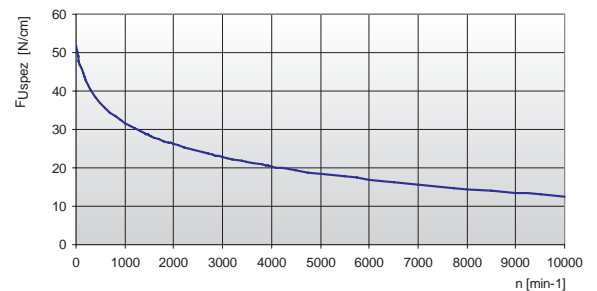



The specific load F_{Uspez} is the maximum load which one single belt tooth 1 cm wide can withstand in all operating conditions. This force is related to the drive rpm.

The total load F_u transmissible by the belt in the drive is calculated by:

$$F_u [N] = F_{Uspez} \cdot Z_e \cdot b$$

- F_u [N] = peripheral force
- F_{Uspez} [N/cm] = specific load
- Z_e = number of teeth in mesh in the small pulley
- Z_{emax} = max. no of teeth in mesh to be considered for the calculation of the drive
- Z_{emax} = 12 for ELATECH® M
- Z_{emax} = 6 for ELATECH® V
- b [cm] = belt width in cm

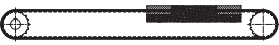
Flexibility

Minimum pulley number of teeth and minimum idler diameter		Type of cord
		STANDARD
Drive without reverse bending 	Timing pulley z_{min}	12
	Flat idler running on belt teeth d_{min}	60 mm
Drive with reverse bending 	Timing pulley z_{min}	20
	Flat idler running on belt back d_{min}	60 mm

Timing pulleys

z	da	dw	z	da	dw	z	da	dw	z	da	dw
10	30,05	31,84	40	125,45	127,32	71	224,15	225,99	101	319,65	321,48
11	33,25	35,02	41	128,65	130,50	72	227,30	229,18	102	322,80	324,66
12	36,35	38,20	42	131,85	133,69	73	230,50	232,36	103	326,00	327,85
13	39,50	41,38	44	138,20	140,05	74	233,70	235,54	104	329,20	331,03
14	42,70	44,56	45	141,40	143,24	75	236,90	238,72	105	332,35	334,21
15	45,90	47,75	46	144,60	146,42	76	240,05	241,94	106	335,55	337,40
16	49,05	50,93	47	147,75	149,60	77	243,25	245,09	107	338,75	340,58
17	52,25	54,11	48	150,95	152,78	78	246,40	248,27	108	341,95	343,76
18	55,45	57,29	49	154,10	155,97	79	249,60	251,46	109	345,15	346,95
19	58,65	60,48	50	157,30	159,15	80	252,80	254,64	110	348,30	350,13
20	61,80	63,66	51	160,50	162,33	81	256,00	257,82	111	351,45	353,31
21	65,00	66,84	52	163,65	165,52	82	259,15	261,00	112	354,65	356,50
22	68,15	70,03	53	166,85	168,70	83	262,30	264,19	113	357,80	359,68
23	71,35	73,20	54	170,05	171,88	84	265,50	267,37	114	361,00	362,86
24	74,55	76,39	55	173,20	175,06	85	268,70	270,55	115	364,19	366,04
25	77,70	79,58	56	176,40	178,25	86	271,90	273,74	116	367,39	369,23
26	80,90	82,76	57	179,60	181,43	87	275,05	276,92	117	370,56	372,41
27	84,10	85,95	58	182,75	184,61	88	278,25	280,10	118	373,76	375,59
28	87,25	89,12	59	185,95	187,80	89	281,45	283,28	119	376,93	378,78
29	90,45	92,21	60	189,10	190,98	90	284,60	286,47	120	380,11	381,96
30	93,65	95,49	61	192,30	194,16	91	287,80	289,65			
31	96,85	98,67	62	195,50	197,35	92	291,00	292,84			
32	100,00	101,86	63	198,65	200,53	93	294,20	296,02			
33	103,20	105,04	64	201,85	203,71	94	297,35	299,20			
34	106,40	108,22	65	205,05	206,90	95	300,55	302,39			
35	109,55	111,41	66	208,20	210,08	96	303,75	305,57			
36	112,75	114,59	67	211,40	213,26	97	306,90	308,75			
37	115,90	117,77	68	214,60	216,44	98	310,10	311,93			
38	119,10	120,95	69	217,75	219,63	99	313,25	315,12			
39	122,30	124,14	70	220,95	222,81	100	316,45	318,30			

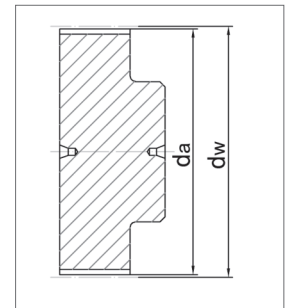

AT 10 TOTAL PROTECTION

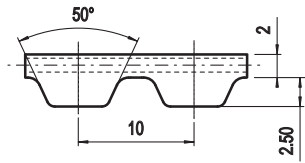

Belt characteristics

- Polyurethane timing belt with steel tension cords
- Metric pitch 10 mm
- Tooth profile and dimension are optimised to guarantee uniform load distribution and minimum deformation under load
- High resistance and low stretch steel cords to guarantee high stability and low elongation
- Reduced polygonal effect with reduced drive vibration
- **TP (Total Protection) belt. The absence of tooth gap makes the belt cords protected against corrosion**
- **Widely used in applications with corrosive environment, high humidity**
- Light blue color available on request

- Width tolerance: $\pm 0,5$ [mm]
- Length tolerance: $\pm 0,8$ [mm/m]
- Thickness tolerance: $\pm 0,2$ [mm]

Technical Data

Belt width b [mm]	Allowable tensile load Type M F_{Tzul} [N]	Allowable tensile load Type V F_{Tzul} [N]	Breaking load Type M F_{Br} [N]	Specific spring rate C_{spez} [N]	Weight [kg/m]
16	2450	1225	9500	612500	0,09
25	4170	2085	16150	1042500	0,15
32	5390	2695	20900	1347500	0,19
50	8580	4290	33250	2145000	0,30
75	12990	6495	50350	3247500	0,44
100	17400	8700	67450	4350000	0,59

Other widths are available on request.

Load / Elongation [%]

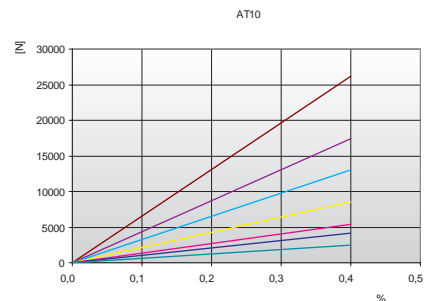

Tooth shear strength

rpm	F_{Uspez} [N/cm]	rpm	F_{Uspez} [N/cm]	rpm	F_{Uspez} [N/cm]	rpm	F_{Uspez} [N/cm]
0	88,57	800	62,83	1900	49,16	4500	34,08
20	87,06	900	61,09	2000	48,29	5000	32,17
40	85,66	1000	59,49	2200	46,67	5500	30,43
60	84,35	1100	58,02	2400	45,18	6000	28,84
80	83,13	1200	56,66	2600	43,80	6500	27,37
100	81,99	1300	55,39	2800	42,51	7000	26,01
200	77,36	1400	54,20	3000	41,30	7500	24,73
300	75,09	1440	53,74	3200	40,17	8000	23,53
400	71,99	1500	53,08	3400	39,09	8500	22,41
500	69,27	1600	52,02	3600	38,08	9000	21,34
600	66,88	1700	51,02	3800	37,11	9500	20,33
700	64,75	1800	50,06	4000	36,20	10000	19,37

Tooth shear strength / rpm

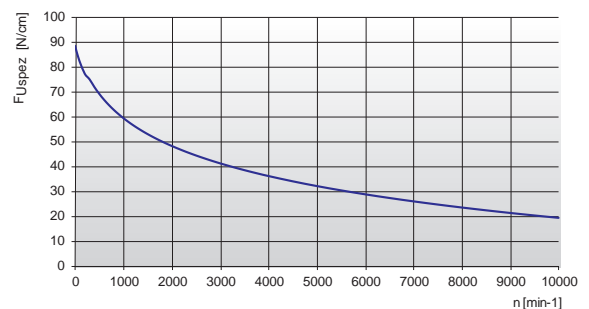

The specific load F_{Uspez} is the maximum load which one single belt tooth 1 cm wide can withstand in all operating conditions.



This force is related to the drive rpm.

The total load F_u transmissible by the belt in the drive is calculated by:

$$F_u [N] = F_{Uspez} \cdot Z_e \cdot b$$

- F_u [N] = peripheral force
- F_{Uspez} [N/cm] = specific load
- Z_e = number of teeth in mesh in the small pulley
- Z_{emax} = max. no of teeth in mesh to be considered for the calculation of the drive
- Z_{emax} = 12 for ELATECH® M
- Z_{emax} = 6 for ELATECH® V
- b [cm] = belt width in cm

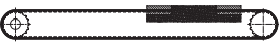
Flexibility

Minimum pulley number of teeth and minimum idler diameter		Type of cord
		STANDARD
Drive without reverse bending 	Timing pulley z_{min}	15
	Flat idler running on belt teeth d_{min}	50 mm
Drive with reverse bending 	Timing pulley z_{min}	25
	Flat idler running on belt back d_{min}	120 mm

Timing pulleys

z	da	dw	z	da	dw	z	da	dw	z	da	dw
18	55,45	57,29	48	150,95	152,78	78	246,40	248,24	108	341,90	343,76
19	58,60	60,48	49	154,10	155,97	79	249,60	251,46	109	345,10	346,95
20	61,80	63,66	50	157,30	159,15	80	252,80	254,64	110	348,30	350,13
21	65,00	66,84	51	160,50	162,33	81	255,95	257,82	111	351,45	353,31
22	68,15	70,03	52	163,65	165,52	82	259,15	261,00	112	354,65	356,50
23	71,35	73,20	53	166,85	168,70	83	262,30	264,19	113	357,80	359,68
24	74,55	76,39	54	170,05	171,88	84	265,50	267,37	114	361,00	362,86
25	77,70	79,58	55	173,20	175,06	85	268,70	270,52	115	364,19	366,04
26	80,90	82,76	56	176,40	178,25	86	271,90	273,74	116	367,39	369,23
27	84,10	85,95	57	179,60	181,43	87	275,05	276,92	117	370,56	372,41
28	87,25	89,12	58	182,75	184,61	88	278,25	280,10	118	373,74	375,59
29	90,45	92,21	59	185,95	187,80	89	281,45	283,28	119	376,93	378,78
30	93,65	95,49	60	189,10	190,98	90	284,60	286,47	120	380,11	381,96
31	96,80	98,67	61	192,30	194,16	91	287,80	289,65			
32	100,00	101,86	62	195,50	197,35	92	291,00	292,84			
33	103,20	105,04	63	198,65	200,53	93	294,20	296,02			
34	106,40	108,19	64	201,85	203,71	94	297,35	299,20			
35	109,55	111,41	65	205,05	206,90	95	300,55	302,39			
36	112,75	114,59	66	208,20	210,08	96	303,70	305,57			
37	115,90	117,77	67	211,40	213,26	97	306,90	308,75			
38	119,10	120,95	68	214,60	216,44	98	310,10	311,93			
39	122,30	124,14	69	217,75	219,63	99	313,25	315,12			
40	125,45	127,32	70	220,95	222,81	100	316,45	318,30			
41	128,65	130,50	71	224,15	225,99	101	319,65	321,48			
42	131,85	133,69	72	227,30	229,18	102	322,80	324,66			
43	135,00	136,87	73	230,50	232,33	103	326,00	327,85			
44	138,20	140,05	74	233,70	235,54	104	329,20	331,03			
45	141,40	143,24	75	236,90	238,72	105	332,35	334,21			
46	144,55	146,42	76	240,05	241,94	106	335,55	337,40			
47	147,75	149,60	77	243,25	245,09	107	338,75	340,58			

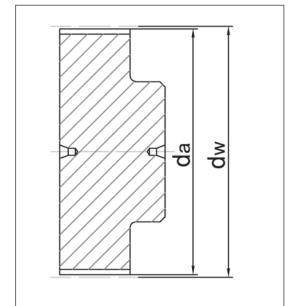

HTD 8M TOTAL PROTECTION

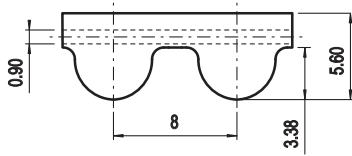

Belt characteristics

- Polyurethane timing belt with round tooth profile and high tensile load tension cords. Produced according to ISO 13050
- Metric pitch 8 mm
- The round tooth profile allows a uniform load distribution that guarantees high performances, high transmissible torque and precise tooth engagement
- **TP (Total Protection) belt. The absence of tooth gap makes the belt protected against corrosion**
- **Widely used in applications with corrosive environment**
- Light blue color available on request

- Width tolerance: $\pm 0,5$ [mm]
- Length tolerance: $\pm 0,5$ [mm/m]
- Thickness tolerance: $\pm 0,2$ [mm]

Technical Data

Belt width b [mm]	Allowable tensile load Type M F_{Tzul} [N]	Allowable tensile load Type V F_{Tzul} [N]	Breaking load Type M F_{Br} [N]	Specific spring rate C_{spez} [N]	Weight [kg/m]
10	1470	735	5700	367500	0,07
15	2210	1105	8550	552500	0,11
20	3190	1595	12350	797500	0,14
30	4900	2450	19000	1225000	0,21
50	8580	4290	33250	2145000	0,35
85	14700	7350	57000	3675000	0,60
100	17400	8700	67450	4350000	0,70

Other widths are available on request.

Load / Elongation [%]

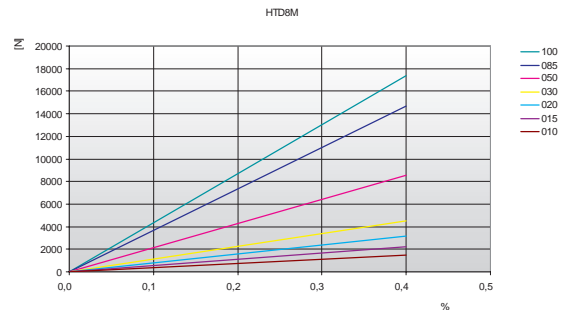

Tooth shear strength

rpm	F_{Uspez} [N/cm]	rpm	F_{Uspez} [N/cm]	rpm	F_{Uspez} [N/cm]	rpm	F_{Uspez} [N/cm]
0	74,00	800	51,20	1900	39,52	4500	26,63
20	72,62	900	49,71	2000	38,78	5000	25,00
40	71,34	1000	48,35	2200	37,39	5500	23,51
60	70,16	1100	47,09	2400	36,12	6000	22,15
80	69,07	1200	45,93	2600	34,94	-	-
100	68,07	1300	44,84	2800	33,83	-	-
200	64,09	1400	43,82	3000	32,80	-	-
300	61,68	1440	43,43	3200	31,83	-	-
400	59,03	1500	42,86	3400	30,91	-	-
500	56,71	1600	41,96	3600	30,05	-	-
600	54,66	1700	41,10	3800	29,22	-	-
700	52,84	1800	40,29	4000	28,44	-	-

Tooth shear strength / rpm

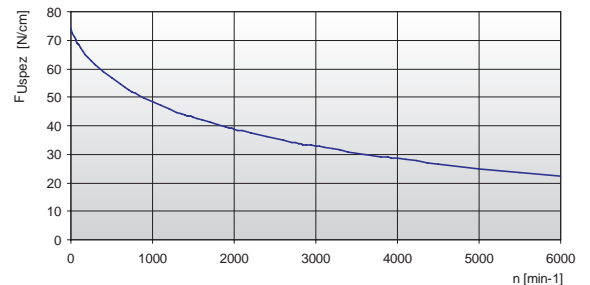



The specific load F_{Uspez} is the maximum load which one single belt tooth 1 cm wide can withstand in all operating conditions. This force is related to the drive rpm. The total load F_U transmissible by the belt in the drive is calculated by:

$$F_U [N] = F_{Uspez} \cdot Z_e \cdot b$$

- $F_U [N]$ = peripheral force
- $F_{Uspez} [N/cm]$ = specific load
- Z_e = number of teeth in mesh in the small pulley
- Z_{emax} = max. no of teeth in mesh to be considered for the calculation of the drive
- Z_{emax} = 12 for ELATECH® M
- Z_{emax} = 6 for ELATECH® V
- $b [cm]$ = belt width in cm

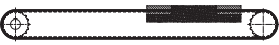
Flexibility

Minimum pulley number of teeth and minimum idler diameter		Type of cord
		STANDARD
Drive without reverse bending 	Timing pulley z_{min}	18
	Flat idler running on belt teeth d_{min}	50 mm
Drive with reverse bending 	Timing pulley z_{min}	18
	Flat idler running on belt back d_{min}	120 mm

Timing pulleys

z	da	dw	z	da	dw	z	da	dw	z	da	dw
18	44,46	45,83	48	120,86	122,23	78	197,25	198,62	108	273,64	275,01
19	47,01	48,38	49	123,40	124,77	79	199,80	201,17	109	276,19	277,56
20	49,56	50,93	50	125,95	127,32	80	202,35	203,72	110	278,74	280,11
21	52,10	53,47	51	128,50	129,87	81	204,89	206,26	111	281,29	282,66
22	54,65	56,02	52	131,05	132,41	82	207,44	208,81	112	283,84	285,21
23	57,20	58,57	53	133,59	134,96	83	209,98	211,35	113	286,38	287,75
24	59,75	61,12	54	136,14	137,51	84	212,53	213,90	114	288,93	290,30
25	62,29	63,66	55	138,68	140,05	85	215,08	216,45	115	291,47	292,84
26	64,84	66,21	56	141,23	142,60	86	217,63	219,00	116	294,02	295,39
27	67,38	68,75	57	143,78	145,15	87	220,17	221,54	117	296,57	297,94
28	70,08	71,30	58	146,32	147,69	88	222,72	224,09	118	299,11	300,48
29	72,59	73,84	59	148,87	150,24	89	225,26	226,63	119	301,66	303,03
30	75,13	76,39	60	151,42	152,79	90	227,81	229,18	120	304,20	305,57
31	77,65	78,94	61	153,96	155,33	91	230,35	231,72			
32	80,16	81,49	62	156,52	157,89	92	232,90	234,27			
33	82,68	84,03	63	159,06	160,43	93	235,45	236,82			
34	85,21	86,58	64	161,60	162,97	94	238,00	239,37			
35	87,76	89,12	65	164,15	165,52	95	240,54	241,91			
36	90,30	91,67	66	166,69	168,06	96	243,09	244,46			
37	92,85	94,22	67	169,24	170,61	97	245,63	247,00			
38	95,40	96,77	68	171,79	173,16	98	248,18	249,55			
39	97,94	99,31	69	174,33	175,70	99	250,73	252,10			
40	100,49	101,86	70	176,88	178,25	100	253,28	254,67			
41	103,04	104,40	71	179,43	180,80	101	255,82	257,19			
42	105,58	106,95	72	181,98	183,35	102	258,37	259,74			
43	108,13	109,50	73	184,52	185,89	103	260,91	262,28			
44	110,68	112,05	74	187,07	188,44	104	263,46	264,83			
45	113,22	114,59	75	189,61	190,98	105	266,01	267,38			
46	115,77	117,14	76	192,16	193,53	106	268,55	269,92			
47	118,31	119,68	77	194,71	196,08	107	271,10	272,47			

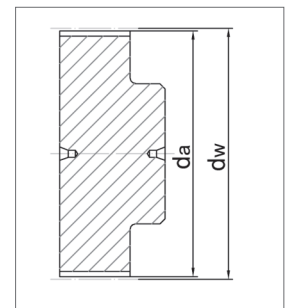

ELATECH® flat belts

ELATECH® flat belt's superior construction makes them the best solution in a wide range of lifting applications. Compared to steel cable they offer proven reliability, highly compact drives, maintenance-free operation and excellent dynamic properties.

Compact size and maintenance-free operation allow:

- low inertia, space savings and therefore lower manufacturing cost solutions
- lower power consumption in operation and therefore reduced running costs

In order to optimize the application in load and flexibility, ELATECH® flat belts are produced in a range of different thicknesses and steel cord diameters.

Pulleys

In some cases it is also possible to use guiding pulleys with a convex barrel shape. In this case we recommend following the specifications of the ISO R22 - DIN 111 norms. The use of the convex barrel pulleys, will result in an uneven force distribution in the belt. Therefore the allowable forces in the belt need to be revised.

Belt storage

Belts must be stored in a dry environment (max 60% relative humidity) with a temperature from 5 to 35 °C.

Belt installation

For a correct belt installation it is important that the belt's ends are securely and firmly fastened by the use of the correct belt end attachments. It is also recommended to use a very rigid and accurate assembly with perfectly parallel and rigid shafts. Belts and pulleys must be free from oil and grease and any dust or residual material which may affect the belt integrity during operation.

Belt fastening guidelines

Belt type [mm]	F1	F2	F2,5	F3
a	25	45	50	75
b	40	60	80	125
p	20	20	20	25
s	3	5	5	5
d	15	30	30	50
Bolt	M5	M6	M8	M8
R (Radius)	12	12	12	20

Pulley [mm]	F1	F2	F2,5	F3
D	50	60	80	120

It's recommended to have at least 2 turns on pulley.

Pulley diameter depends on the type of belt and on the design load required by the application. Our catalogue suggests minimum diameters for use with the maximum allowable load. For an accurate pulley diameter calculation under different load conditions please contact our technical department.

The recommended pulley geometry is cylindrical with side flanges.

Proper design of belt ends is recommended to ensure application safety. Some possible design solutions for belt end clamping are shown here as examples.

ELATECH® flat belts are produced with a polyurethane body ensuring very high wear resistance. Steel tension cords of opposite construction (Z and S) are laid out in pairs to maximize dynamic properties. They provide excellent operational performance with low noise and vibrations and long lifetime.

In applications with more belts acting in parallel it is suggested to use belts from the same manufacturing batch with minimum belt thickness tolerance. The belt drive must be started up only when the entire machine or assembly has the necessary protective systems which meet the machine's safety guidelines. Belts are maintenance free, however, an accurate visual inspection of the belts and end attachments must be taken at least once per year.

TP (Total Protection) Belts

TP flat belts (without tooth gap) are available on demand. Ask our technical Department for product specifications.

Belt life

Due to the wide application range and considering the fact that belts are one component of complex equipment, the loads in the belt itself are very seldom precisely predictable. This fact makes it impossible to confirm a precise belt service life. In order to optimize the belt life, it is important to follow the catalogue technical specifications related to pulley geometry and belt storage and installation. When all the catalogues of specifications are followed, a belt life of 3 million reverse bending cycles occurring over 10 years can be expected. This value was measured in tests under laboratory conditions.

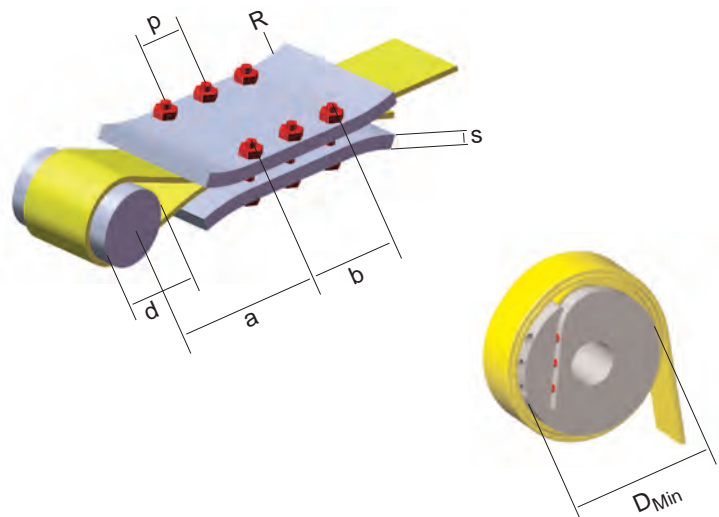

F1



Belt characteristics

- Polyurethane flat belt with steel tension cords
- It is mainly used in lifting applications where there is no need for synchronization
- Allows the use of small diameter pulleys and compact drive design
- Black colour as standard
- Maintenance free
- Reduced thickness tolerance available on request

- Width tolerance: $\pm 0,5$ [mm]
- Thickness tolerance: $\pm 0,2$ [mm]

Technical Data

Belt width b [mm]	Allowable tensile load Type M F_{Tzul} [N]	Allowable tensile load Type V F_{Tzul} [N]	Breaking load Type M F_{Br} [N]	Specific spring rate C_{spez} [N]	Weight [kg/m]
10	320	160	1250	80000	0,02
20	700	350	2750	175000	0,04
30	1090	545	4250	272500	0,05
40	1470	735	5750	367500	0,08
50	1860	930	7250	465000	0,09
100	3780	1890	14750	945000	0,21

Load / Elongation [%]

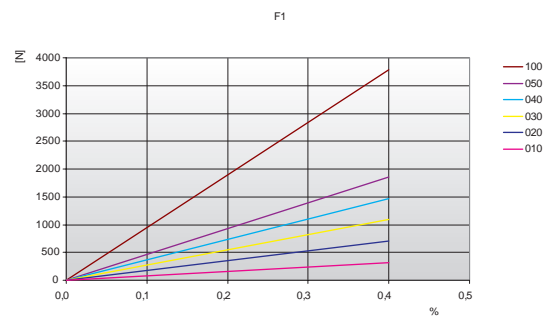

Other widths are available on request.

Minimum pulley diameter	Drive without reverse bending [mm]	Drive with reverse bending [mm]
	16	30

Specialties

Belt width b [mm]	ARAMID CORD	
	F_{Tzul} [N] M type	F_{Br} [N]
10	700	2800
20	1540	6160
30	2380	9520
40	3220	12880
50	4060	16240
100	8260	33040



Belt characteristics

- Polyurethane flat belt with steel tension cords
- It is mainly used in lifting application where there is no need for synchronization
- Allows the use of small diameter pulleys
- Black colour as standard
- Maintenance free
- Reduced thickness tolerance available on request

- Width tolerance: $\pm 0,5$ [mm]
- Thickness tolerance: $\pm 0,2$ [mm]

Technical Data

Belt width b [mm]	Allowable tensile load Type M F_{Tzul} [N]	Allowable tensile load Type V F_{Tzul} [N]	Breaking load Type M F_{Br} [N]	Specific spring rate C_{spez} [N]	Weight [kg/m]
10	1470	735	5700	367500	0,03
15	2210	1105	8550	552500	0,05
25	4170	2085	16150	1042500	0,08
30	4660	2330	18050	1165000	0,10
50	8580	4290	33250	2145000	0,17
75	12990	6495	50350	3247500	0,25
100	17400	8700	67450	4350000	0,34

Load / Elongation [%]

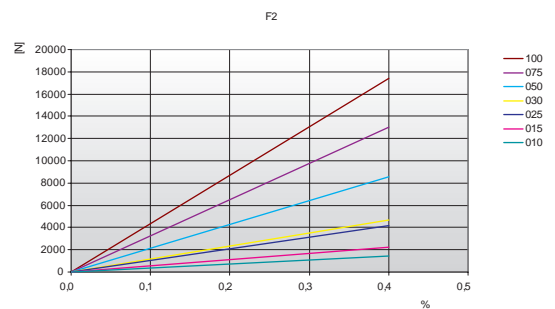

Other widths are available on request.

Minimum pulley diameter	Drive without reverse bending [mm]	Drive with reverse bending [mm]
	50	100

Specialties

Belt width b [mm]	ARAMID CORD		STAINLESS STEEL	
	F_{Tzul} [N] M type	F_{Br} [N]	F_{Tzul} [N] M type	F_{Br} [N]
10	1320	6000	1080	4500
15	1980	9000	1620	6750
25	3740	17000	3060	12750
30	4180	19000	3420	14250
50	7700	35000	6300	26250
75	11660	53000	9540	39750
100	15620	71000	12780	53250

F2,5



- Width tolerance: $\pm 0,5$ [mm]
- Thickness tolerance: $\pm 0,2$ [mm]

Belt characteristics

- Polyurethane flat belt with steel tension cords
- It is mainly used in lifting application where there is no need for synchronization
- Allows the use of small diameter pulleys
- Black colour as standard
- Maintenance free
- Reduced thickness tolerance available on request

Technical Data

Belt width b [mm]	Allowable tensile load Type M F_{Tzul} [N]	Allowable tensile load Type V F_{Tzul} [N]	Breaking load Type M F_{Br} [N]	Specific spring rate C_{spez} [N]	Weight [kg/m]
20	5280	2640	19250	1320000	0,08
25	6720	3360	24500	1680000	0,09
50	14400	7200	52500	3600000	0,18
75	21600	10800	78750	5400000	0,27
100	29280	14640	106750	7320000	0,36
120	35040	17520	127750	8760000	0,42

Other widths are available on request.

Load / Elongation [%]

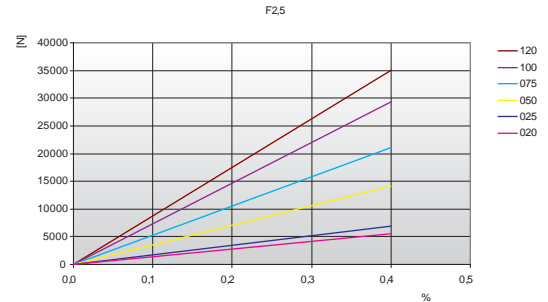

Minimum pulley diameter	Drive without reverse bending [mm]	Drive with reverse bending [mm]
	80	150

F3



- Width tolerance: $\pm 0,5$ [mm]
- Thickness tolerance: $\pm 0,2$ [mm]

Belt characteristics

- Polyurethane flat belt with steel tension cords
- It is mainly used in lifting application where there is no need for synchronization
- Allows the use of small diameter pulleys
- Black colour as standard
- Maintenance free
- Reduced thickness tolerance available on request

Technical Data

Belt width b [mm]	Allowable tensile load Type M F_{Tzul} [N]	Allowable tensile load Type V F_{Tzul} [N]	Breaking load Type M F_{Br} [N]	Specific spring rate C_{spez} [N]	Weight [kg/m]
25	8500	3400	32000	2125000	0,11
30	10200	5100	38400	2550000	0,12
60	21250	10625	80000	5312500	0,24
120	43350	21675	163200	10837500	0,48

Other widths are available on request.

Load / Elongation [%]

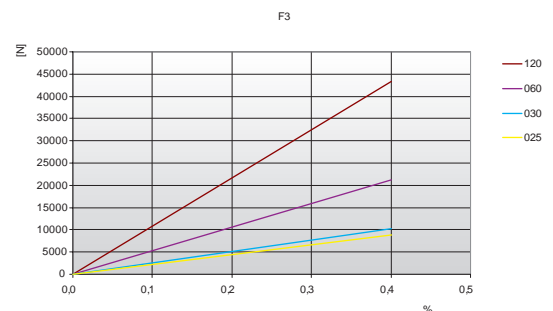

Minimum pulley diameter	Drive without reverse bending [mm]	Drive with reverse bending [mm]
	120	180

FLAT Heavy Series

ELATECH® FLAT belt heavy series has been developed for the need in the automotive industry. They are used to lift car bodies in production lines or to convey car bodies or finished cars (skid supporting belt). They are made with 85 Sh A polyurethane body to ensure high grip on the motor pulley and with high performance steel tension member.

F8

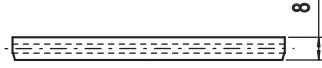

Belt characteristics

- Polyurethane flat belt with steel tension cords
- Long service life
- Black colour as standard
- Maintenance free
- Minimum elastic elongation

F8 - Technical Data

- Width tolerance: $\pm 1,5$ [mm]
- Thickness tolerance: $\pm 0,8$ [mm]

Belt width b [mm]	Allowable tensile load Type M F_{Tzul} [N]	Breaking load Type M F_{Br} [N]	Specific spring rate C_{spez} [N]	Weight [kg/m]
60	34800	157200	8700000	1,2
120	69600	314400	17400000	2,4

Other widths are available on request.

Minimum pulley diameter	Drive without reverse bending [mm]	Drive with reverse bending [mm]
	250	300

Load / Elongation [%]

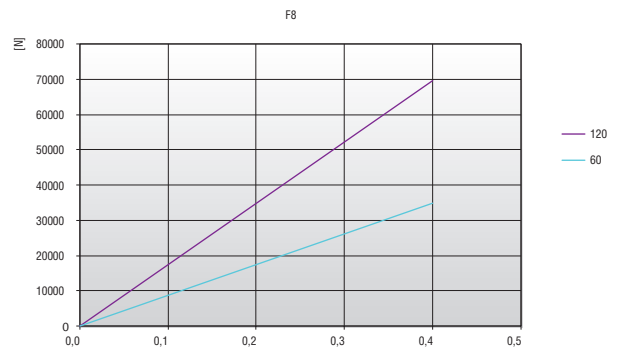

F9



Belt characteristics

- Polyurethane flat belt with steel tension cords
- Long service life
- Black colour as standard
- Maintenance free
- Minimum elastic elongation

F9 - Technical Data

- Width tolerance: $\pm 1,5$ [mm]
- Thickness tolerance: $\pm 0,8$ [mm]

Belt width b [mm]	Allowable tensile load Type M F_{Tzul} [N]	Breaking load Type M F_{Br} [N]	Specific spring rate C_{spez} [N]	Weight [kg/m]
105	37400	148500	9350000	1,7
125	44000	175500	11000000	2,1
150	55000	220500	13750000	2,5

Other widths are available on request.

Minimum pulley diameter	Drive without reverse bending [mm]	Drive with reverse bending [mm]
	200	250

Load / Elongation [%]

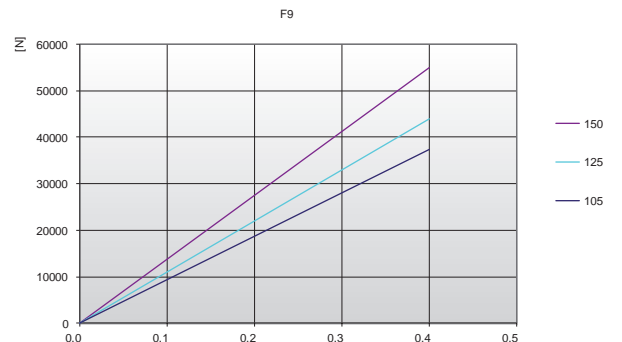

POLY-V K

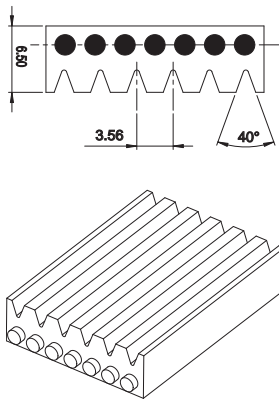

Belt characteristics

- Polyurethane Poly-V belt with K profile and high tensile load steel cords for high performance and increased flexibility
- The Poly-V profile allows torque high transmission, small pulley diameter
- Low noise generation
- Widely used in lifting applications

- Width tolerance: $\pm 1,0$ [mm]
- Thickness tolerance: $\pm 0,4$ [mm]

Technical Data

Belt width b [mm]	Allowable tensile load Type M F_{Tzul} [N]	Breaking load Type M F_{Br} [N]	Specific spring rate C_{spez} [N]	Weight [kg/m]
25	7700	31500	1925000	0,35
30	17600	72000	4400000	0,70
75	27500	112500	6875000	1,10
100	35200	144000	8800000	1,45
150	55000	225000	13750000	2,20

Other widths are available on request.

Load / Elongation [%]

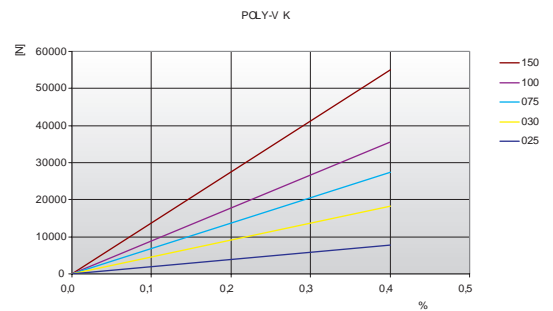

Minimum pulley diameter	Drive without reverse bending [mm]	Drive with reverse bending [mm]
	150	250

TT5 Polyurethane timing belts

ELATECH® manufactures special TT5 belts which have been expressly designed for application in circular knitting machines drives.

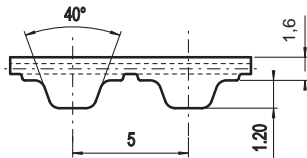

Belt characteristics

- Trapezoidal tooth profile according to DIN 7721 T1
- Metric pitch 5 mm
- Standard colour: blue with kevlar cords, white with steel cords, other colours available on request
- Polyurethane 88 Sh A

- Width tolerance: $\pm 0,5$ [mm]
- Length tolerance: $\pm 0,5$ [mm/m]
- Thickness tolerance: $\pm 0,2$ [mm]

Technical Data

ELATECH® belts TT5 are available in the following executions:

ELATECH® - V

- A special splicing and welding process offers superior traction load resistance
- They are available both with steel and aramid cords
- Special colours available on demand
- Available in any length tooth by tooth



ELA-flex SD™ truly endless

- ELA-flex SD™ TT5 have no splice and welding and therefore offer best traction resistance load
- They are available both with steel and aramid cords
- Special colours available on demand
- Available in all lengths tooth by tooth up to a length of 13500 mm

Belt width b [mm]	Allowable tensile load Type M F_{Tzul} [N]	Allowable tensile load Type V F_{Tzul} [N]	Breaking load Type M F_{Br} [N]	Weight [kg/m]
ARAMID (Kevlar) cords				
10	840	420	3360	0,019
STEEL cords				
10	320	190	1250	0,021

Type	Belt length [mm]	Type	Belt length [mm]
10TT5/4800K	4800	10TT5/9200K	9200
10TT5/5000K	5000	10TT5/9400K	9400
10TT5/5200K	5200	10TT5/9600K	9600
10TT5/5600K	5600	10TT5/9800K	9800
10TT5/5800K	5800	10TT5/10000K	10000
10TT5/6000K	6000	10TT5/10200K	10200
10TT5/6200K	6200	10TT5/10300K	10300
10TT5/6400K	6400	10TT5/10400K	10400
10TT5/6600K	6600	10TT5/10600K	10600
10TT5/6800K	6800	10TT5/10800K	10800
10TT5/7000K	7000	10TT5/11200K	11200
10TT5/7200K	7200	10TT5/11300K	11300
10TT5/7400K	7400	10TT5/11800K	11800
10TT5/7500K	7500	10TT5/12000K	12000
10TT5/7600K	7600	10TT5/12300K	12300
10TT5/7800K	7800	10TT5/12700K	12700
10TT5/8000K	8000	10TT5/12800K	12800
10TT5/8200K	8200	10TT5/13000K	13000
10TT5/8300K	8300	10TT5/13200K	13200
10TT5/8400K	8400	10TT5/13400K	13400
10TT5/8600K	8600	10TT5/13600K	13600
10TT5/8800K	8800	10TT5/15400K	15400
10TT5/8900K	8900	10TT5/17900K	17900
10TT5/9000K	9000		

Flexibility

Minimum pulley number of teeth and minimum idler diameter		Type of cord	
		STANDARD	ARAMID
	Timing pulley z_{min}	12	12
	Flat idler running on belt teeth d_{min}	30 mm	30 mm
	Timing pulley z_{min}	15	15
	Flat idler running on belt back d_{min}	30 mm	30 mm

Note: Steel tensile cord member available upon request

Clamp plates

Clamp plates may be used as positive attachment of the belt ends in numerous applications in linear drives. Clamp plates must have the correct belt profile, guarantee a uniform clamping force on all the clamped belt surface and must be rigid.

For standard applications a minimum of 7 teeth in clamp is recommended. For use with timing belts with HPL cords, a minimum of 12 teeth in clamp is recommended.

EAGLE™ clamp plates are available as semi finished product. Standard material for clamp plates is aluminium.

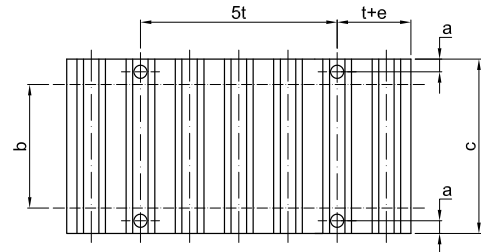
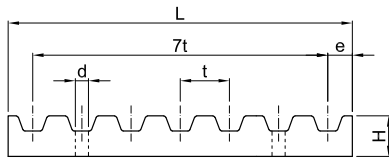

Type	a [mm]	d [mm]	e [mm]	L [mm]	H [mm]	Belt width [mm]							
						6	10	16	25	32	50	75	100
T5	6	5,5	3,2	41,8	8	-	29	35	44	-	-	-	-
AT5	6	5,5	3,2	41,8	8	-	29	35	44	-	-	-	-
T10	8	9	5	80	15	-	-	41	50	57	75	100	125
AT10	8	9	5	80	15	-	-	41	50	57	75	100	125
T20	10	11	10	160	20	-	-	-	56	63	81	106	132
AT20	10	11	10	160	20	-	-	-	56	63	81	106	132

Type	a [mm]	d [mm]	e [mm]	L [mm]	H [mm]	Belt width [inch/100]							
						025	032	037	050	075	100	150	200
XL	6	5,5	3,5	42,5	8	25,5	27	28,5	-	-	-	-	-
L	8	9	6	76,6	15	-	-	36	39	45	51,5	64	77
H	10	11	9	106,9	22	-	-	-	45	51	57,5	70	83

Type	a [mm]	d [mm]	e [mm]	L [mm]	H [mm]	Belt width [mm]								
						15	20	25	30	40	50	55	85	115
5M	6	5,5	3,4	41,8	8	34	-	44	-	-	-	-	-	-
8M	8	9	5	66	15	40	45	-	55	-	75	-	110	-
14M	10	11	9	116	22	-	-	56	-	71	-	86	116	146

EAGLE Belts	Clamp plates					Belt width [mm]										
	Pitch	b	d	f	Length [mm]	H	12,5	25	16	25	32	50	35	52,5	70	105
							Clamp plate width [mm]									
EAGLE 5	6	5,5	8,5	47	7,5	30	-	-	-	-	-	-	-	-	-	-
	7					45	-	-	-	-	-	-	-	-	-	-
EAGLE 8	7,5	9	13	74	14,5	-	-	40	-	-	-	-	-	-	-	-
	8					-	-	50	57	75	-	-	-	-	-	
EAGLE 10	8	9	17	94	14,5	-	-	-	50	57	75	-	-	-	-	-
EAGLE 14	9,5	11	23	130	22	-	-	-	-	-	-	65	82,5	100	-	-
	10					-	-	-	-	-	-	-	-	-	-	136

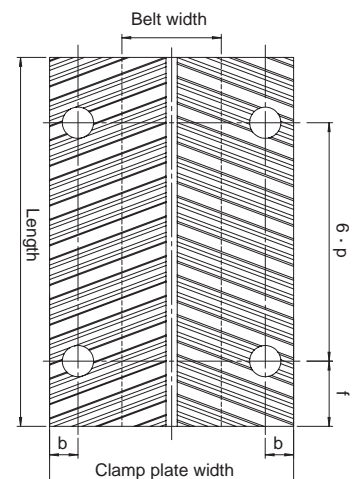
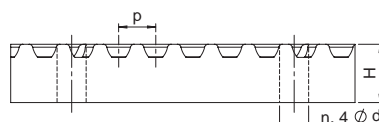

ELATECH® SYNCRO-MAX™

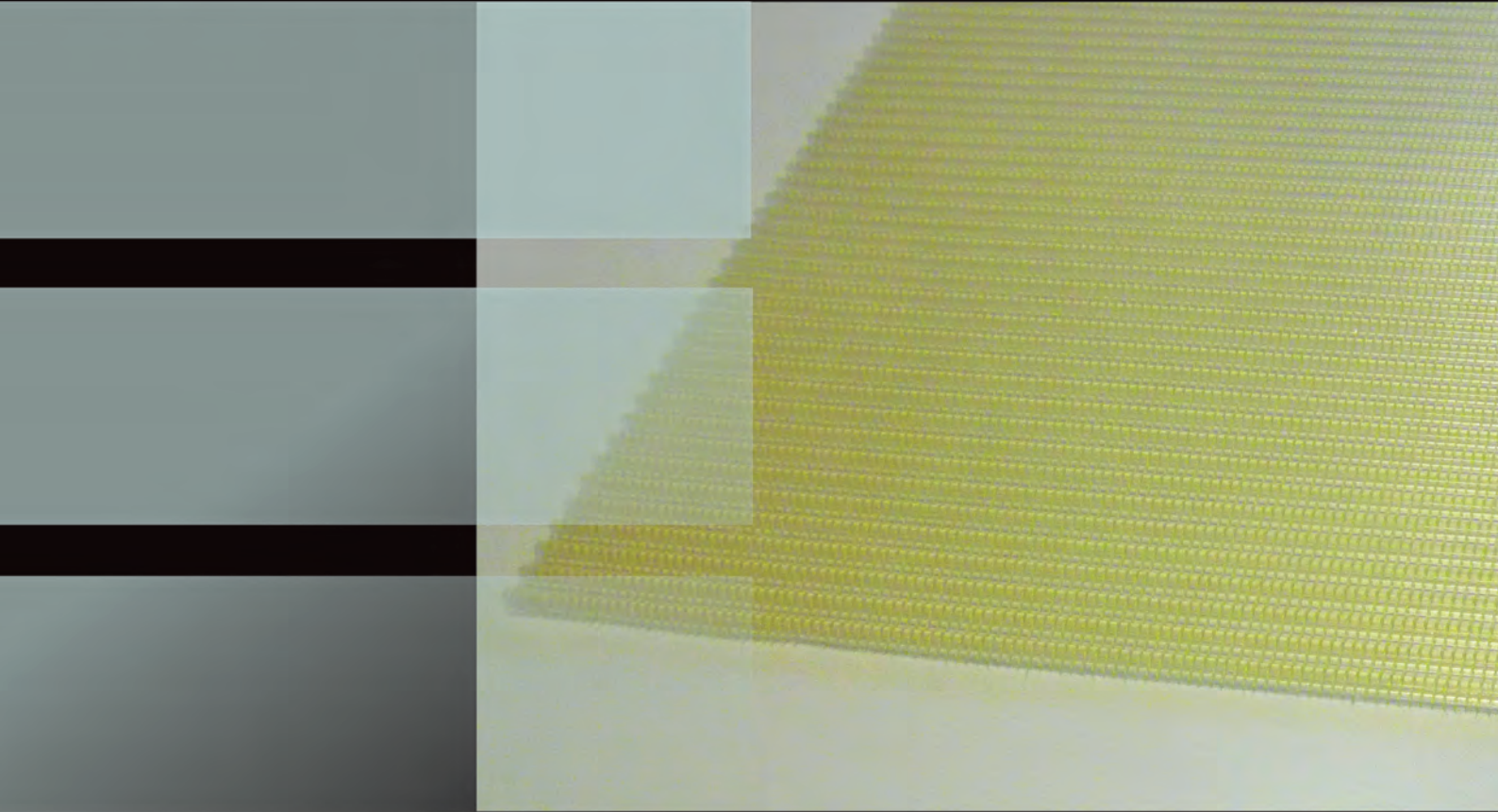

ELATECH® SYNCRO-MAX™ - Extra-wide

ELATECH® SYNCRO-MAX™ Extra-wide Polyurethane Belts extend the advantages of synchronous timing belts to wider surfaces and to the typical applications of flat and modular conveyor belts.

Made of Polyurethane and reinforced with Aramid, ELATECH® SYNCRO-MAX™ Extra-wide Belts provide positive drive and synchronous conveying resulting in no slippage, better tracking, higher indexing/positioning precision, smaller drive pulley requirements, lower belt tension, lower shaft loads and consequently power saving.

Open or jointed, coated with Silicon, Rubber, PU or PVC backings, perforated or grooved with complex design, and equipped with a wide range of tracking guides and profiles of different shapes and dimensions, ELATECH® SYNCRO-MAX™ Extra-wide Belts offer the best solution for a great number of applications such as the production of baby diapers and feminine hygiene products and the production of tires as well as in many other industrial fields like food, tobacco, metal, wood, glass, and of course conveying and packaging.

Product overview

- Natural colour PU compound material
- High durability
- Cut resistant
- Grease, chemicals and water resistant
- Non-marking
- Kevlar (Aramid) parallel cord reinforcement
- No cords exposure on belt edges
- Even cord tension

Available options

- FDA-compliant PU compound
- PAZ/PAR for noise reduction
- Tracking guides on teeth and/or on back
- Silicon, PU, PVC and rubber backings
- Wide range of cleats, flights and profiles
- Perforation by high precision water-jet cutting technology

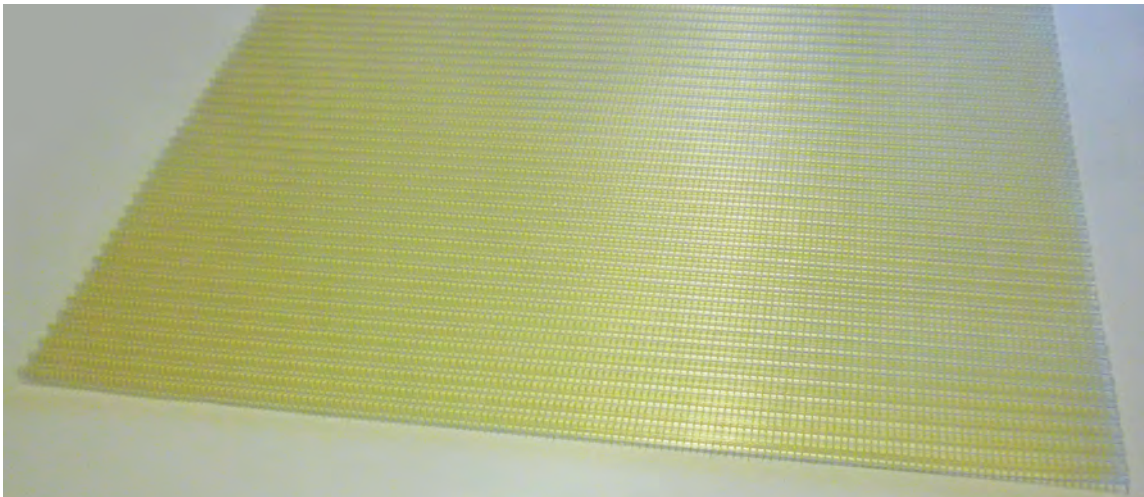

SYNCRO-MAX™ W-T10

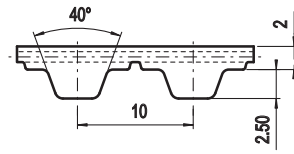
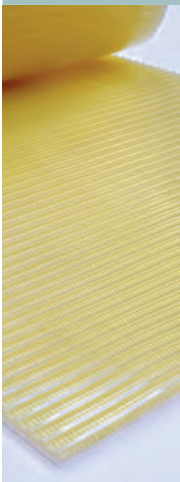

Belt characteristics

- Polyurethane timing belt with Aramid tension cords
- Trapezoidal tooth profile according to DIN 7721 T1
- Metric pitch 10 mm
- Natural colour PU compound 92 Sh A
- Standard roll length = 100 m

- Width tolerance: $\pm 1,0$ [mm]
- Thickness tolerance: $\pm 0,3$ [mm]

Technical Data

Belt width b [mm]	Allowable tensile load Type M F_{Tzul} [N]	Allowable tensile load Type V F_{Tzul} [N]	Breaking load Type M F_{Br} [N]	Specific spring rate C_{spez} [N]	Weight [kg/m]
200	8140	4070	31159	1017500	0,76
250	10210	5105	39088	1276250	0,95
300	12280	6140	47016	1535000	1,14
350	14360	7180	54945	1795000	1,33
400	16430	8215	62874	2053750	1,52
450	18500	9250	70802	2312500	1,71
500	20570	10285	78731	2571250	1,90

Flexibility

Minimum pulley number of teeth and minimum idler diameter	Type of cord	
	ARAMID	
 Drive without reverse bending	Timing pulley z_{min}	15
	Flat idler running on belt teeth d_{min}	60 mm
 Drive with reverse bending	Timing pulley z_{min}	20
	Flat idler running on belt back d_{min}	60 mm

Other widths are available on request.

Tooth shear strength

rpm	F_{Uspez} [N/cm]	rpm	F_{Uspez} [N/cm]	rpm	F_{Uspez} [N/cm]	rpm	F_{Uspez} [N/cm]
0	51,80	800	33,34	1900	26,53	4500	19,40
20	50,32	900	32,44	2000	26,12	5000	18,51
40	49,04	1000	31,63	2200	25,34	5500	17,70
60	47,92	1100	30,89	2400	24,63	6000	16,97
80	46,95	1200	30,21	2600	23,97	6500	16,29
100	46,11	1300	29,58	2800	23,36	7000	15,66
200	42,75	1400	28,99	3000	22,78	7500	15,07
300	40,28	1440	28,76	3200	22,25	8000	14,52
400	38,36	1500	28,44	3400	21,74	8500	14,00
500	36,80	1600	27,92	3600	21,27	9000	13,51
600	35,49	1700	27,43	3800	20,81	9500	13,05
700	34,35	1800	26,97	4000	20,39	10000	12,61

Tooth shear strength / rpm

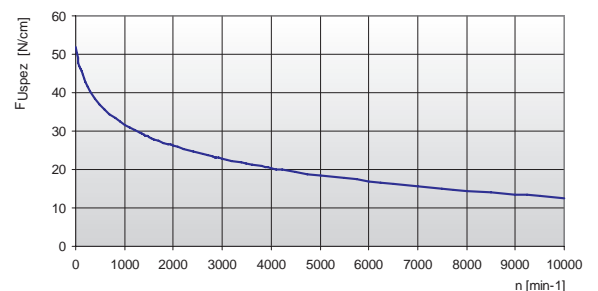

The specific load F_{Uspez} is the maximum load which one single belt tooth 1 cm wide can withstand in all operating conditions. This force is related to the drive rpm. The total load F_u transmissible by the belt in the drive is calculated by:

$$F_u \text{ [N]} = F_{Uspez} \cdot z_e \cdot b$$

Note: Ultimate tensile strengths are listed for reference purposes only. The values listed above are a theoretical calculation based on average cord strength and may not represent actual tensile test results.

- F_u [N] = peripheral force
- F_{Uspez} [N/cm] = specific load
- z_e = number of teeth in mesh in the small pulley
- z_{emax} = max. no of teeth in mesh to be considered for the calculation of the drive = 12 for ELATECH® M
- z_{emax} = 6 for ELATECH® V
- b [cm] = belt width in cm

SYNCRO-MAX™ W-H

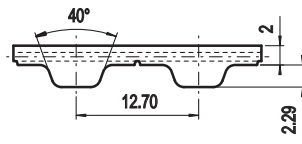
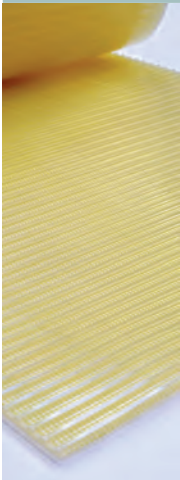

Belt characteristics

- Polyurethane timing belt with Aramid tension cord
- Trapezoidal tooth profile according to DIN/ISO 5296
- Imperial pitch 1/2" = 12,7 mm
- Natural colour PU compound 92 Sh A
- Standard roll length = 100 m

- Width tolerance: ±1,0 [mm]
- Thickness tolerance: ±0,3 [mm]

Technical Data

Belt width b Code / mm	Allowable tensile load Type M F _{Tzul} [N]	Allowable tensile load Type V F _{Tzul} [N]	Breaking load Type M F _{Br} [N]	Specific spring rate C _{spez} [N]	Weight [kg/m]
8 / 203,2	8140	4070	31159	1017500	0,70
10 / 254	10210	5105	39088	1276250	0,90
12 / 304,8	12280	6140	47016	1535000	1,05
14 / 355,6	14360	7180	54945	1795000	1,24
16 / 406,4	16430	8215	62874	2053750	1,42
18 / 457,2	18500	9250	70802	2312500	1,60
20 / 508	20570	10285	78731	2571250	1,80

Flexibility

Minimum pulley number of teeth and minimum idler diameter	Type of cord	
	ARAMID	
 Drive without reverse bending	Timing pulley z _{min}	14
	Flat idler running on belt teeth d _{min}	60 mm
 Drive with reverse bending	Timing pulley z _{min}	20
	Flat idler running on belt back d _{min}	80 mm

Other widths are available on request.

Tooth shear strength

rpm	F _{Uspez} [N/cm]	rpm	F _{Uspez} [N/cm]	rpm	F _{Uspez} [N/cm]	rpm	F _{Uspez} [N/cm]
0	45,30	800	29,04	1900	23,11	4500	16,88
20	43,95	900	28,26	2000	22,74	5000	16,11
40	42,78	1000	27,55	2200	22,07	5500	15,41
60	41,77	1100	26,90	2400	21,44	6000	14,76
80	40,88	1200	26,31	2600	20,87	6500	14,17
100	40,11	1300	25,76	2800	20,34	7000	13,62
200	37,22	1400	25,25	3000	19,84	7500	13,11
300	35,07	1440	25,05	3200	19,37	8000	12,63
400	33,41	1500	24,77	3400	18,93	8500	12,18
500	32,05	1600	24,32	3600	18,51	9000	11,75
600	30,90	1700	23,89	3800	18,12	9500	11,35
700	29,91	1800	23,49	4000	17,75	10000	10,96

Tooth shear strength / rpm

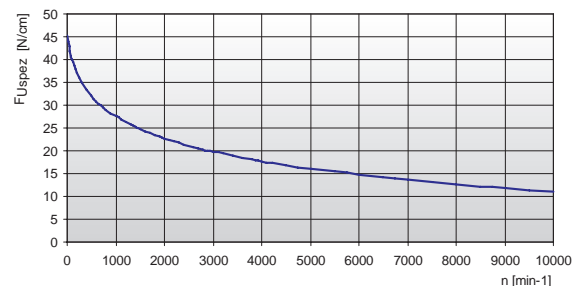

The specific load F_{Uspez} is the maximum load which one single belt tooth 1 cm wide can withstand in all operating conditions. This force is related to the drive rpm. The total load F_u transmissible by the belt in the drive is calculated by:

$$F_u [N] = F_{Uspez} \cdot z_e \cdot b$$

Note: Ultimate tensile strengths are listed for reference purposes only. The values listed above are a theoretical calculation based on average cord strength and may not represent actual tensile test results.

- F_u [N] = peripheral force
- F_{Uspez} [N/cm] = specific load
- z_e = number of teeth in mesh in the small pulley
- z_{emax} = max. no of teeth in mesh to be considered for the calculation of the drive = 12 for ELATECH® M
- z_{emax} = 6 for ELATECH® V
- b [cm] = belt width in cm

ELA-flex SD™ timing belts

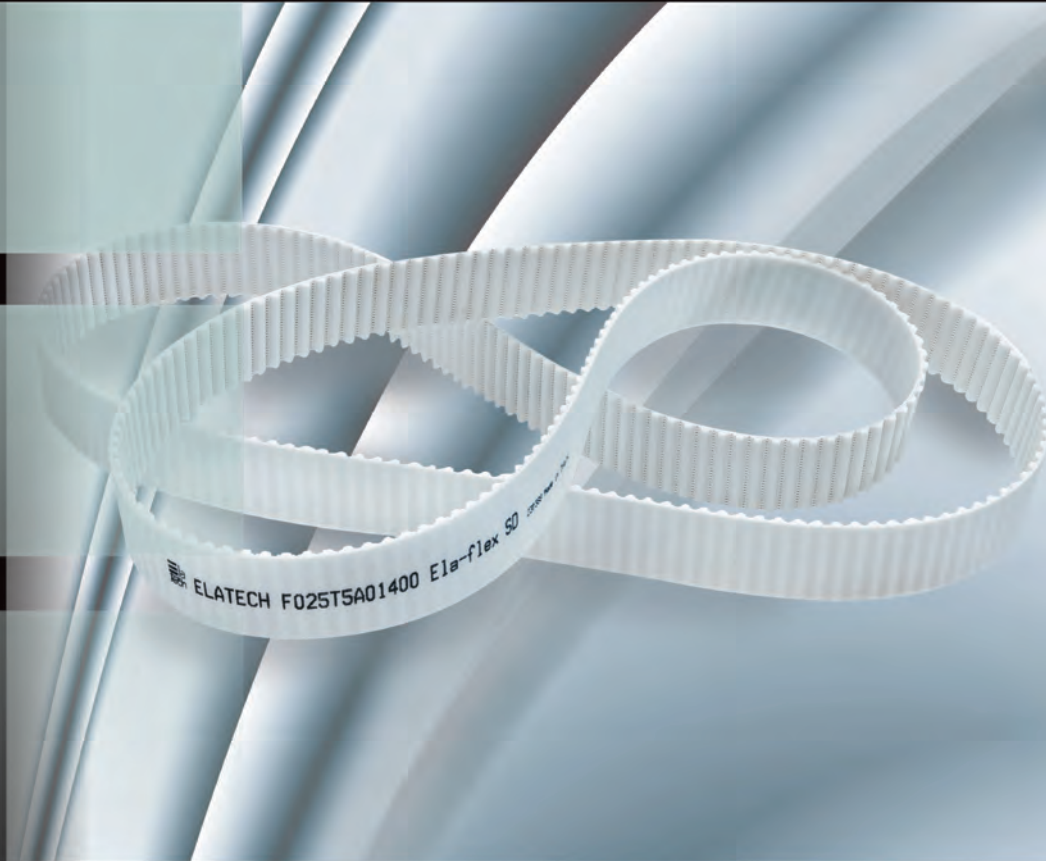

ELA-flex SD™ Synchro Drive timing belts

ELA-flex SD™ timing belts are manufactured with truly endless high tension strength steel tension cords and high wear, abrasion and tear resistant polyurethane.

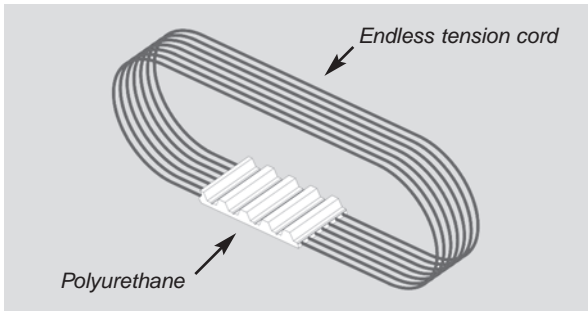

Having no splice or welding, the belts have no weak cross sections. ELA-flex SD™ timing belts are therefore ideal for high speed power transmission and high load conveying applications.

The unique high tech manufacturing process designed by our research and development allows the production of every belt length, tooth by tooth from a **minimum of 800 mm** to a maximum of 20.000 mm to permit the best flexibility in application.

Length tolerances

Belt length [mm]	Length tolerance (+/-) [mm]	Belt length [mm]	Length tolerance (+/-) [mm]
900	0,75	4000	2,11
1100	0,85	4250	2,24
1300	0,95	4500	2,32
1500	1,04	4750	2,40
1700	1,13	5000	2,52
1900	1,22	5300	2,64
2120	1,30	5600	2,72
2240	1,35	6000	2,92
2360	1,44	6300	3,04
2500	1,49	6700	3,19
2650	1,57	7100	3,35
2800	1,61	7500	3,51
3000	1,70	8000	3,70
3550	1,91	9000	4,09
3750	2,03	more	on request

Double sided timing belts

On demand it is possible to supply ELA-flex SD™ as double sided belts. Please ask for the minimum quantity.

Special cords

In order to solve any design needs, ELA-flex SD™ belts may be produced with special cords:

- HPL** high performance
- HFE** high Flexibility
- INOX** stainless steel for high aggressive environments
- ARAMID** low weight, non magnetic

Antistatic belts

On request it is possible to deliver ELA-flex SD™ belts with anti-static properties by using a specific electrically conductive coating or a special compound. A minimum quantity is applied.

Product certification

- ELATECH® belts are certified according to RoHS 2002/95/EC
- On request, it is possible to deliver belts with antistatic properties.

Thickness and width tolerance

Standard ELA-flex SD™ belts are ground on the back and are manufactured at precise width (see technical tables). For special application needs, special thickness and width tolerances can be produced.

Belt designation

Metric pitch

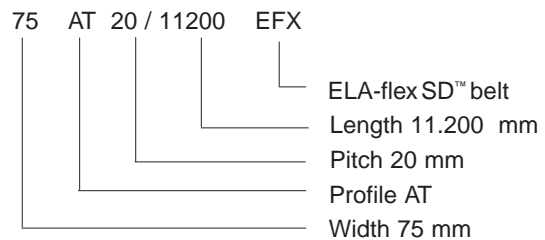

Inch pitch

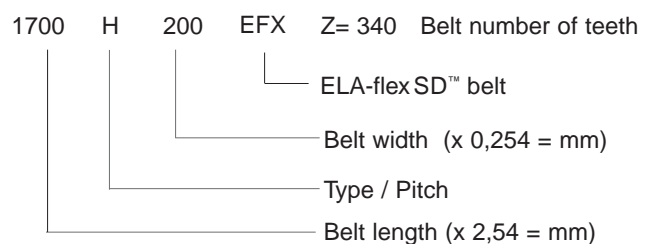

ELA-flex SD™

T 5

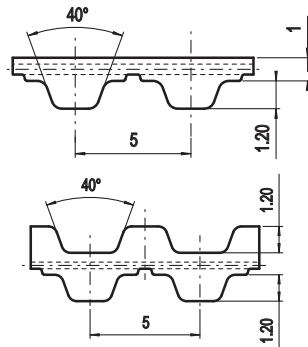
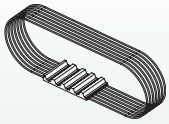

Belt characteristics

- Truly endless polyurethane timing belt with steel tension cords according to DIN 7721 T1
- Metric pitch 5 mm
- Ideal for drives where high belt flexibility is required
- Allows the use of small diameter pulleys
- Transmissible power up to 5 kW
- Rpm up to 10.000 [1/min]
- **Dual tooting available from 1500 mm**

- Maximum width: 150 [mm]
- Width tolerance: ±0,5 [mm]
- Thickness tolerance: ±0,2 [mm]

Technical Data

Belt width [mm]	10	16	25	32	50	75	100	150
Allowable tensile load [N]	320	530	840	1090	1720	2600	3450	5170
Weight [kg/m]	0,02	0,03	0,05	0,07	0,11	0,16	0,21	0,32

Other widths are available on request.

Tooth shear strength

rpm [min ⁻¹]	M _{spez} [Ncm/cm]	P _{spez} [W/cm]	rpm [min ⁻¹]	M _{spez} [Ncm/cm]	P _{spez} [W/cm]	rpm [min ⁻¹]	M _{spez} [Ncm/cm]	P _{spez} [W/cm]
0	1,966	0,000	1200	1,252	1,573	3400	0,972	3,462
20	1,915	0,040	1300	1,231	1,676	3600	0,957	3,609
40	1,872	0,078	1400	1,211	1,776	3800	0,942	3,749
60	1,834	0,115	1440	1,204	1,815	4000	0,928	3,886
80	1,802	0,151	1500	1,194	1,875	4500	0,895	4,218
100	1,773	0,186	1600	1,176	1,971	5000	0,866	4,533
200	1,663	0,348	1700	1,160	2,065	5500	0,840	4,835
300	1,583	0,497	1800	1,145	2,158	6000	0,815	5,120
400	1,520	0,637	1900	1,131	2,250	6500	0,793	5,395
500	1,468	0,769	2000	1,116	2,338	7000	0,772	5,658
600	1,425	0,895	2200	1,091	2,513	7500	0,753	5,912
700	1,388	1,017	2400	1,068	2,684	8000	0,735	6,153
800	1,354	1,135	2600	1,046	2,847	8500	0,717	6,382
900	1,325	1,249	2800	1,026	3,007	9000	0,701	6,607
1000	1,299	1,360	3000	1,007	3,162	9500	0,686	6,824
1100	1,274	1,467	3200	0,989	3,314	10000	0,672	7,033

The total power "P" and the total torque "M" transmitted by the belt, are calculated with the following formulas:

$$P \text{ [kW]} = P_{\text{spez}} \cdot Z_e \cdot Z_k \cdot b / 1000$$

$$M \text{ [Nm]} = M_{\text{spez}} \cdot Z_e \cdot Z_k \cdot b / 100$$

$$Z_e = \frac{Z_k \cdot \arccos \left[\frac{t \cdot (z_g - z_k)}{2 \cdot \pi \cdot A} \right]}{180}$$

P = power in kW

M = torque in Nm

P_{spez} = specific power

M_{spez} = specific torque

Z_e = number of teeth in mesh of the small pulley

Z_{emax} = 12

Z_k = number of teeth of the small pulley

b = belt width in cm

A = centre distance [mm]

t = pitch

Flexibility

Minimum pulley number of teeth and minimum idler diameter			
Drive without reverse bending		Timing pulley Z _{min}	10
		Flat idler running on belt teeth d _{min}	30 mm
Drive with reverse bending		Timing pulley Z _{min}	15
		Flat idler running on belt back d _{min}	30 mm

Minimum available length

Execution	Max width	
	100 mm	150 mm
Standard	≥ 800 mm	≥ 1500 mm
PAZ	≥ 800 mm	≥ 1800 mm

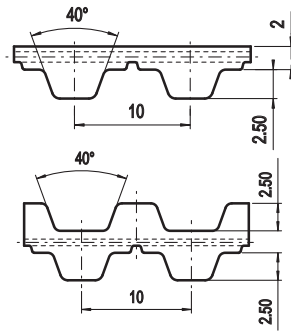
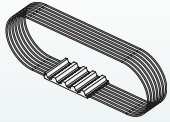
Belt characteristics

- Truly endless polyurethane timing belt with steel tension cords according to DIN 7721 T1
- Metric pitch 10 mm
- Ideal for drives where high belt flexibility is required
- Allows the use of small diameter pulleys
- Transmissible power up to 30 kW
- Rpm up to 10.000 [1/min]
- **Dual toothing available from 1500 mm**

- Maximum width: 150 [mm]
- Width tolerance: ±0,5 [mm]
- Thickness tolerance: ±0,2 [mm]

Technical Data

Belt width [mm]	10	16	25	32	50	75	100	150
Allowable tensile load [N]	890	1520	2280	3040	4680	7080	9490	14170
Weight [kg/m]	0,05	0,07	0,12	0,15	0,23	0,35	0,46	0,69

Other widths are available on request.

Tooth shear strength

rpm [min ⁻¹]	M _{spez} [Ncm/cm]	P _{spez} [W/cm]	rpm [min ⁻¹]	M _{spez} [Ncm/cm]	P _{spez} [W/cm]	rpm [min ⁻¹]	M _{spez} [Ncm/cm]	P _{spez} [W/cm]
0	8,244	0,000	1200	4,808	6,042	3400	3,460	12,318
20	8,009	0,168	1300	4,708	6,409	3600	3,385	12,761
40	7,805	0,327	1400	4,614	6,764	3800	3,312	13,179
60	7,627	0,479	1440	4,577	6,902	4000	3,245	13,592
80	7,472	0,626	1500	4,526	7,109	4500	3,088	14,549
100	7,339	0,768	1600	4,444	7,445	5000	2,946	15,424
200	6,804	1,425	1700	4,366	7,771	5500	2,817	16,224
300	6,411	2,014	1800	4,292	8,090	6000	2,701	16,969
400	6,105	2,557	1900	4,222	8,401	6500	2,593	17,646
500	5,857	3,066	2000	4,157	8,706	7000	2,492	18,269
600	5,648	3,549	2200	4,033	9,291	7500	2,398	18,836
700	5,467	4,007	2400	3,920	9,851	8000	2,311	19,359
800	5,306	4,445	2600	3,815	10,386	8500	2,228	19,832
900	5,163	4,866	2800	3,718	10,901	9000	2,150	20,264
1000	5,034	5,271	3000	3,626	11,389	9500	2,077	20,661
1100	4,916	5,663	3200	3,541	11,866	10000	2,007	21,015

The total power "P" and the total torque "M" transmitted by the belt, are calculated with the following formulas:

$$P \text{ [kW]} = P_{\text{spez}} \cdot z_e \cdot z_k \cdot b / 1000$$

$$M \text{ [Nm]} = M_{\text{spez}} \cdot z_e \cdot z_k \cdot b / 100$$

$$z_e = \frac{z_k \cdot \arccos \left[\frac{t \cdot (z_g - z_k)}{2 \cdot \pi \cdot A} \right]}{180}$$

P = power in kW

M = torque in Nm

P_{spez} = specific power

M_{spez} = specific torque

z_e = number of teeth in mesh of the small pulley

z_{emax} = 12

z_k = number of teeth of the small pulley

b = belt width in cm

A = centre distance [mm]

t = pitch

Flexibility

Minimum pulley number of teeth and minimum idler diameter			
Drive without reverse bending		Timing pulley z _{min}	12
		Flat idler running on belt teeth d _{min}	60 mm
Drive with reverse bending		Timing pulley z _{min}	20
		Flat idler running on belt back d _{min}	60 mm

Minimum available length

Execution	Max width	
	100 mm	150 mm
Standard	≥ 800 mm	≥ 1500 mm
PAZ	≥ 800 mm	≥ 1800 mm

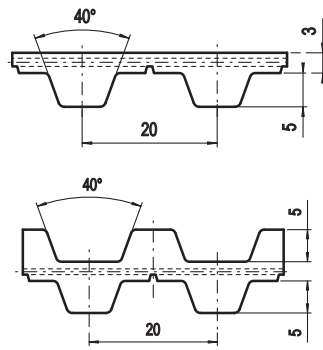
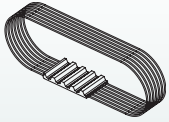

Belt characteristics

- Truly endless polyurethane timing belt with steel tension cords according to DIN 7721 T1
- Metric pitch 20 mm
- Ideal for drives where high belt flexibility is required
- Transmissible power up to 100 kW
- Rpm up to 6.000 [1/min]
- **Dual toothing available from 1500 mm**
- **HPL cord execution available**

- Maximum width: 150 [mm]
- Width tolerance: ±1,0 [mm]
- Thickness tolerance: ±0,2 [mm]

Technical Data

Belt width [mm]	25	32	50	75	100	150
Allowable tensile load [N]	4040	5120	8090	12400	16440	24790
Weight [kg/m]	0,18	0,23	0,37	0,55	0,73	1,10

Other widths are available on request.

Tooth shear strength

rpm [min ⁻¹]	M _{spez} [Ncm/cm]	P _{spez} [W/cm]	rpm [min ⁻¹]	M _{spez} [Ncm/cm]	P _{spez} [W/cm]	rpm [min ⁻¹]	M _{spez} [Ncm/cm]	P _{spez} [W/cm]
0	33,263	0,000	1200	17,542	22,042	3400	11,510	40,978
20	32,181	0,674	1300	17,093	23,268	3600	11,173	42,117
40	31,242	1,309	1400	16,673	24,442	3800	10,851	43,178
60	30,424	1,911	1440	16,511	24,896	4000	10,546	44,170
80	29,714	2,489	1500	16,278	25,568	4500	9,842	46,377
100	29,097	3,047	1600	15,909	26,654	5000	9,209	48,213
200	26,579	5,566	1700	15,562	27,702	5500	8,639	49,753
300	24,777	7,783	1800	15,234	28,714	6000	8,114	50,976
400	23,393	9,798	1900	14,922	29,689	6500	7,630	51,931
500	22,269	11,659	2000	14,623	30,624	-	-	-
600	21,320	13,395	2200	14,069	32,411	-	-	-
700	20,502	15,028	2400	13,563	34,086	-	-	-
800	19,783	16,572	2600	13,092	35,643	-	-	-
900	19,140	18,038	2800	12,659	37,116	-	-	-
1000	18,561	19,435	3000	12,252	38,487	-	-	-
1100	18,029	20,766	3200	11,870	39,773	-	-	-

The total power "P" and the total torque "M" transmitted by the belt, are calculated with the following formulas:

$$P \text{ [kW]} = P_{spez} \cdot Z_e \cdot Z_k \cdot b / 1000$$

$$M \text{ [Nm]} = M_{spez} \cdot Z_e \cdot Z_k \cdot b / 100$$

$$Z_e = \frac{Z_k}{180} \cdot \arccos \left[\frac{t \cdot (Z_g - Z_k)}{2 \cdot \pi \cdot A} \right]$$

- P = power in kW
- M = torque in Nm
- P_{spez} = specific power
- M_{spez} = specific torque
- Z_e = number of teeth in mesh of the small pulley
- Z_{emax} = 12
- Z_k = number of teeth of the small pulley
- b = belt width in cm
- A = centre distance [mm]
- t = pitch

Flexibility

Minimum pulley number of teeth and minimum idler diameter			
Drive without reverse bending		Timing pulley Z _{min}	15
		Flat idler running on belt teeth d _{min}	120 mm
Drive with reverse bending		Timing pulley Z _{min}	25
		Flat idler running on belt back d _{min}	120 mm

Minimum available length

Execution	Max width	
	100 mm	150 mm
Standard	≥ 900 mm	≥ 1500 mm
PAZ	≥ 900 mm	≥ 1800 mm

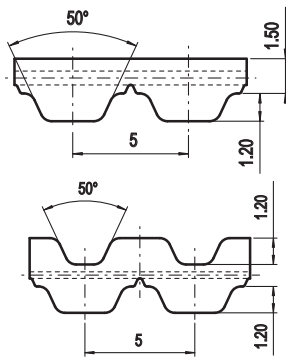
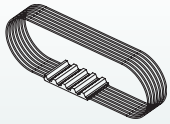

Belt characteristics

- Truly endless polyurethane timing belt with steel tension cords.
- Metric pitch 5 mm
- Tooth profile and dimension are optimised to guarantee uniform load distribution and minimum deformation under load
- High resistance and low stretch steel cords to guarantee high stability and low elongation
- Reduced polygonal effect with reduced drive vibration and noise
- Transmissible power up to 15 kW
- Rpm up to 10.000 [1/min]
- **Dual tothing available from 1500 mm**

- Maximum width: 150 [mm]
- Width tolerance: ±0,5 [mm]
- Thickness tolerance: ±0,2 [mm]

Technical Data

Belt width [mm]	10	16	25	32	50	75	100	150
Allowable tensile load [N]	890	1520	2280	3040	4680	7080	9490	14230
Weight [kg/m]	0,03	0,05	0,08	0,11	0,17	0,25	0,33	0,50

Other widths are available on request.

Tooth shear strength

rpm [min ⁻¹]	M _{spez} [Ncm/cm]	P _{spez} [W/cm]	rpm [min ⁻¹]	M _{spez} [Ncm/cm]	P _{spez} [W/cm]	rpm [min ⁻¹]	M _{spez} [Ncm/cm]	P _{spez} [W/cm]
0	2,897	0,000	1200	2,027	2,547	3400	1,514	5,391
20	2,855	0,060	1300	1,990	2,709	3600	1,485	5,598
40	2,817	0,118	1400	1,955	2,866	3800	1,456	5,795
60	2,783	0,175	1440	1,942	2,929	4000	1,429	5,986
80	2,753	0,231	1500	1,923	3,020	4500	1,367	6,442
100	2,725	0,285	1600	1,892	3,170	5000	1,311	6,862
200	2,620	0,549	1700	1,863	3,316	5500	1,260	7,255
300	2,540	0,798	1800	1,836	3,460	6000	1,213	7,619
400	2,458	1,030	1900	1,809	3,599	6500	1,169	7,957
500	2,383	1,248	2000	1,784	3,736	7000	1,128	8,271
600	2,317	1,456	2200	1,736	4,000	7500	1,091	8,568
700	2,258	1,655	2400	1,693	4,256	8000	1,055	8,839
800	2,204	1,846	2600	1,653	4,500	8500	1,023	9,101
900	2,153	2,029	2800	1,615	4,734	9000	0,991	9,337
1000	2,108	2,207	3000	1,580	4,962	9500	0,961	9,555
1100	2,066	2,379	3200	1,546	5,181	10000	0,933	9,766

The total power "P" and the total torque "M" transmitted by the belt, are calculated with the following formulas:

$$P \text{ [kW]} = P_{\text{spez}} \cdot Z_e \cdot Z_k \cdot b / 1000$$

$$M \text{ [Nm]} = M_{\text{spez}} \cdot Z_e \cdot Z_k \cdot b / 100$$

$$Z_e = \frac{Z_k \cdot \arccos \left[\frac{t \cdot (Z_g - Z_k)}{2 \cdot \pi \cdot A} \right]}{180}$$

- P = power in kW
- M = torque in Nm
- P_{spez} = specific power
- M_{spez} = specific torque
- Z_e = number of teeth in mesh of the small pulley
- Z_{emax} = 12
- Z_k = number of teeth of the small pulley
- b = belt width in cm
- A = centre distance [mm]
- t = pitch

Flexibility

Minimum pulley number of teeth and minimum idler diameter			
Drive without reverse bending		Timing pulley Z _{min}	15
		Flat idler running on belt teeth d _{min}	30 mm
Drive with reverse bending		Timing pulley Z _{min}	25
		Flat idler running on belt back d _{min}	60 mm

Minimum available length

Execution	Max width	
	100 mm	150 mm
Standard	≥ 800 mm	≥ 1500 mm
PAZ	≥ 800 mm	≥ 1800 mm

ELA-flex SD™ AT 10

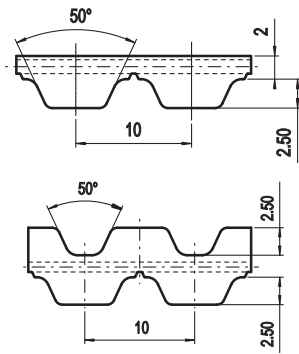
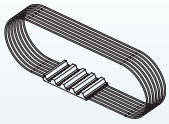

Belt characteristics

- Truly endless polyurethane timing belt with steel tension cords.
- Metric pitch 10 mm
- Tooth profile and dimension are optimised to guarantee uniform load distribution and minimum deformation under load
- High resistance and low stretch steel cords to guarantee high stability and low elongation
- Reduced polygonal effect with reduced drive vibration and noise
- Transmissible power up to 70 kW
- Rpm up to 10.000 [1/min]
- **Dual tothing available from 1500 mm**
- **HPL cord execution available**

- Maximum width: 150 [mm]
- Width tolerance: ±0,5 [mm]
- Thickness tolerance: ±0,2 [mm]

Technical Data

Belt width [mm]	16	25	32	50	75	100	150
Allowable tensile load [N]	2430	4040	5120	8090	12400	16440	24790
Weight [kg/m]	0,09	0,14	0,18	0,29	0,43	0,57	0,86

Other widths are available on request.

Tooth shear strength

rpm [min ⁻¹]	M _{spez} [Ncm/cm]	P _{spez} [W/cm]	rpm [min ⁻¹]	M _{spez} [Ncm/cm]	P _{spez} [W/cm]	rpm [min ⁻¹]	M _{spez} [Ncm/cm]	P _{spez} [W/cm]
0	14,096	0,000	1200	9,018	11,331	3400	6,222	22,152
20	13,856	0,290	1300	8,815	12,000	3600	6,060	22,846
40	13,633	0,571	1400	8,626	12,645	3800	5,907	23,504
60	13,424	0,843	1440	8,553	12,897	4000	5,761	24,130
80	13,230	1,108	1500	8,447	13,268	4500	5,424	25,557
100	13,049	1,366	1600	8,279	13,871	5000	5,120	26,807
200	12,312	2,578	1700	8,119	14,454	5500	4,844	27,897
300	11,951	3,754	1800	7,968	15,018	6000	4,591	28,841
400	11,457	4,799	1900	7,824	15,566	6500	4,357	29,652
500	11,025	5,772	2000	7,686	16,097	7000	4,139	30,339
600	10,644	6,687	2200	7,429	17,113	7500	3,936	30,912
700	10,305	7,553	2400	7,191	18,072	8000	3,746	31,377
800	10,000	8,377	2600	6,971	18,978	8500	3,566	31,742
900	9,723	9,163	2800	6,766	19,836	9000	3,397	32,012
1000	9,469	9,915	3000	6,573	20,649	9500	3,236	32,193
1100	9,235	10,637	3200	6,393	21,420	10000	3,084	32,289

The total power "P" and the total torque "M" transmitted by the belt, are calculated with the following formulas:

$$P \text{ [kW]} = P_{\text{spez}} \cdot Z_e \cdot Z_k \cdot b / 1000$$

$$M \text{ [Nm]} = M_{\text{spez}} \cdot Z_e \cdot Z_k \cdot b / 100$$

$$Z_e = \frac{Z_k}{180} \cdot \arccos \left[\frac{t \cdot (Z_g - Z_k)}{2 \cdot \pi \cdot A} \right]$$

P = power in kW

M = torque in Nm

P_{spez} = specific power

M_{spez} = specific torque

Z_e = number of teeth in mesh of the small pulley

Z_{emax} = 12

Z_k = number of teeth of the small pulley

b = belt width in cm

A = centre distance [mm]

t = pitch

Flexibility

Minimum pulley number of teeth and minimum idler diameter			
Drive without reverse bending		Timing pulley Z _{min}	15
		Flat idler running on belt teeth d _{min}	50 mm
Drive with reverse bending		Timing pulley Z _{min}	25
		Flat idler running on belt back d _{min}	120 mm

Minimum available length

Execution	Max width	
	100 mm	150 mm
Standard	≥ 800 mm	≥ 1500 mm
PAZ	≥ 800 mm	≥ 1800 mm

ELA-flex SD™ ATM 10

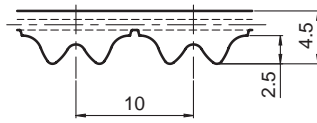
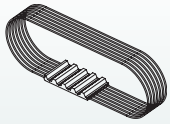

Belt characteristics

- Truly endless polyurethane timing belt with steel tension cords.
- Metric pitch 10 mm
- Tooth profile and dimension are optimised to guarantee uniform load distribution and minimum deformation under load
- High resistance and low stretch steel cords to guarantee high stability and low elongation
- Reduced polygonal effect with reduced drive vibration and noise
- Transmissible power up to 70 kW
- Rpm up to 10.000 [1/min]
- **Max. length 2500 mm**

- Maximum width: 100 [mm]
- Width tolerance: ±0,5 [mm]
- Thickness tolerance: ±0,2 [mm]

Technical Data

Belt width [mm]	16	25	32	50	75	100
Allowable tensile load [N]	2430	4040	5120	8090	12400	16440
Weight [kg/m]	0,09	0,14	0,18	0,29	0,43	0,57

Other widths are available on request.

Tooth shear strength

rpm [min ⁻¹]	M _{spez} [Ncm/cm]	P _{spez} [W/cm]	rpm [min ⁻¹]	M _{spez} [Ncm/cm]	P _{spez} [W/cm]	rpm [min ⁻¹]	M _{spez} [Ncm/cm]	P _{spez} [W/cm]
0	15,51	0,00	1200	9,92	12,46	3400	6,84	24,37
20	15,22	0,32	1300	9,70	13,20	3600	6,67	25,13
40	14,95	0,63	1400	9,49	13,91	3800	6,50	25,85
60	14,70	0,92	1440	9,41	14,19	4000	6,34	26,54
80	14,47	1,21	1500	9,29	14,59	4500	5,97	28,11
100	14,26	1,49	1600	9,11	15,26	5000	5,63	29,49
200	13,41	2,81	1700	8,93	15,90	5500	5,33	30,69
300	13,15	4,13	1800	8,76	16,52	6000	5,05	31,73
400	12,60	5,28	1900	8,61	17,12	6500	4,79	32,62
500	12,13	6,35	2000	8,45	17,71	7000	4,55	33,37
600	11,71	7,36	2200	8,17	18,82	7500	4,33	34,00
700	11,34	8,31	2400	7,91	19,88	8000	4,12	34,51
800	11,00	9,21	2600	7,67	20,88	8500	3,92	34,92
900	10,69	10,08	2800	7,44	21,82	9000	3,74	35,21
1000	10,42	10,91	3000	7,23	22,71	9500	3,56	35,41
1100	10,16	11,70	3200	7,03	23,56	10000	3,39	35,52

The total power "P" and the total torque "M" transmitted by the belt, are calculated with the following formulas:

$$P \text{ [kW]} = P_{\text{spez}} \cdot Z_e \cdot Z_k \cdot b / 1000$$

$$M \text{ [Nm]} = M_{\text{spez}} \cdot Z_e \cdot Z_k \cdot b / 100$$

$$Z_e = \frac{Z_k}{180} \cdot \arccos \left[\frac{t \cdot (Z_g - Z_k)}{2 \cdot \pi \cdot A} \right]$$

P = power in kW

M = torque in Nm

P_{spez} = specific power

M_{spez} = specific torque

Z_e = number of teeth in mesh of the small pulley

Z_{emax} = 12

Z_k = number of teeth of the small pulley

b = belt width in cm

A = centre distance [mm]

t = pitch

Flexibility

Minimum pulley number of teeth and minimum idler diameter			
Drive without reverse bending		Timing pulley Z _{min}	15
		Flat idler running on belt teeth d _{min}	50 mm
Drive with reverse bending		Timing pulley Z _{min}	25
		Flat idler running on belt back d _{min}	120 mm

Minimum available length

Execution	Max width 100 mm
Standard	≥ 800 mm
PAZ	≥ 800 mm

ELA-flex SD™ AT 20

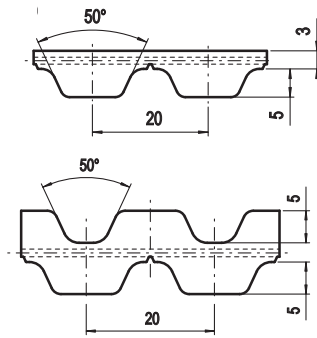
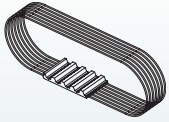

Belt characteristics

- Truly endless polyurethane timing belt with steel tension cords. Metric pitch 20 mm
- Tooth profile and dimension are optimised to guarantee uniform load distribution and minimum deformation under load
- High resistance and low stretch steel cords to guarantee high stability and low elongation
- Reduced polygonal effect with reduced drive vibration and noise
- Transmissible power up to 200 kW
- Rpm up to 6.000 [1/min]
- **Dual tothing available from 1500 mm**
- **HPL cord execution available**

- Maximum width: 150 [mm]
- Width tolerance: ±1,0 [mm]
- Thickness tolerance: ±0,2 [mm]

Technical Data

Belt width [mm]	25	32	50	75	100	150
Allowable tensile load [N]	5810	7920	12140	18480	24290	36960
Weight [kg/m]	0,24	0,31	0,48	0,73	0,97	1,45

Other widths are available on request.

Tooth shear strength

rpm [min ⁻¹]	M _{spez} [Ncm/cm]	P _{spez} [W/cm]	rpm [min ⁻¹]	M _{spez} [Ncm/cm]	P _{spez} [W/cm]	rpm [min ⁻¹]	M _{spez} [Ncm/cm]	P _{spez} [W/cm]
0	48,192	0,000	1200	27,063	34,006	3400	15,842	56,402
20	47,288	0,990	1300	26,251	35,734	3600	15,196	57,284
40	46,438	1,945	1400	25,487	37,363	3800	14,579	58,009
60	45,639	2,867	1440	25,197	37,994	4000	13,993	58,609
80	44,885	3,760	1500	24,771	38,907	4500	12,643	59,576
100	44,175	4,626	1600	24,096	40,370	5000	11,427	59,829
200	41,199	8,628	1700	23,456	41,755	5500	10,320	59,432
300	38,923	12,227	1800	22,845	43,059	6000	9,304	58,456
400	36,911	15,460	1900	22,269	44,305	-	-	-
500	35,157	18,407	2000	21,715	45,477	-	-	-
600	33,617	21,120	2200	20,681	47,641	-	-	-
700	32,248	23,637	2400	19,729	49,580	-	-	-
800	31,016	25,982	2600	18,844	51,303	-	-	-
900	29,899	28,177	2800	18,023	52,841	-	-	-
1000	28,880	30,241	3000	17,252	54,196	-	-	-
1100	27,938	32,180	3200	16,527	55,377	-	-	-

The total power "P" and the total torque "M" transmitted by the belt, are calculated with the following formulas:

$$P \text{ [kW]} = P_{\text{spez}} \cdot Z_e \cdot Z_k \cdot b / 1000$$

$$M \text{ [Nm]} = M_{\text{spez}} \cdot Z_e \cdot Z_k \cdot b / 100$$

$$Z_e = \frac{Z_k}{180} \cdot \arccos \left[\frac{t \cdot (Z_g - Z_k)}{2 \cdot \pi \cdot A} \right]$$

P = power in kW

M = torque in Nm

P_{spez} = specific power

M_{spez} = specific torque

Z_e = number of teeth in mesh of the small pulley

Z_{emax} = 12

Z_k = number of teeth of the small pulley

b = belt width in cm

A = centre distance [mm]

t = pitch

Flexibility

Minimum pulley number of teeth and minimum idler diameter			
Drive without reverse bending		Timing pulley Z _{min}	18
		Flat idler running on belt teeth d _{min}	120 mm
Drive with reverse bending		Timing pulley Z _{min}	25
		Flat idler running on belt back d _{min}	180 mm

Minimum available length

Execution	Max width	
	100 mm	150 mm
Standard	≥ 900 mm	≥ 1500 mm
PAZ	≥ 900 mm	≥ 1800 mm

ELA-flex SD™ XL

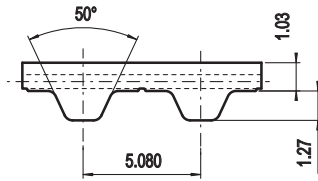
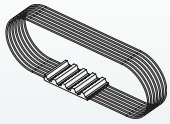

Belt characteristics

- Truly endless polyurethane timing belt with steel tension cords and trapezoidal tooth profile according to DIN/ISO 5296.
- Imperial pitch 1/5" = 5,08 mm
- Allow to use small diameter pulley
- Mainly used in applications where inch pitch is an advantage
- Transmissible power up to 5 kW
- Rpm up to 10.000 [1/min]

- Maximum width: 150 [mm]
- Width tolerance: ±0,5 [mm]
- Thickness tolerance: ±0,2 [mm]

Technical Data

Belt width [inch]	0,25	0,37	0,50	0,75	1,00	1,50	2,00	4,00
Allowable tensile load [N]	210	320	420	630	880	1300	1760	3520
Weight [kg/m]	0,016	0,024	0,033	0,049	0,065	0,098	0,130	0,260

Other widths are available on request.

Tooth shear strength

rpm [min ⁻¹]	M _{spez} [Ncm/cm]	P _{spez} [W/cm]	rpm [min ⁻¹]	M _{spez} [Ncm/cm]	P _{spez} [W/cm]	rpm [min ⁻¹]	M _{spez} [Ncm/cm]	P _{spez} [W/cm]
0	2,029	0,000	1200	1,294	1,626	3400	1,006	3,581
20	1,978	0,041	1300	1,273	1,732	3600	0,990	3,730
40	1,932	0,081	1400	1,252	1,836	3800	0,974	3,877
60	1,894	0,119	1440	1,245	1,877	4000	0,960	4,020
80	1,860	0,156	1500	1,234	1,938	4500	0,926	4,362
100	1,830	0,192	1600	1,216	2,037	5000	0,896	4,690
200	1,717	0,360	1700	1,200	2,136	5500	0,868	5,001
300	1,635	0,514	1800	1,184	2,231	6000	0,843	5,298
400	1,570	0,658	1900	1,169	2,326	6500	0,820	5,580
500	1,518	0,795	2000	1,155	2,418	7000	0,798	5,849
600	1,473	0,926	2200	1,129	2,600	7500	0,779	6,115
700	1,434	1,051	2400	1,104	2,776	8000	0,759	6,360
800	1,400	1,173	2600	1,082	2,945	8500	0,741	6,599
900	1,370	1,291	2800	1,061	3,110	9000	0,725	6,835
1000	1,342	1,405	3000	1,041	3,271	9500	0,709	7,053
1100	1,317	1,517	3200	1,023	3,427	10000	0,695	7,272

The total power "P" and the total torque "M" transmitted by the belt, are calculated with the following formulas:

$$P \text{ [kW]} = P_{\text{spez}} \cdot Z_e \cdot Z_k \cdot b / 1000$$

$$M \text{ [Nm]} = M_{\text{spez}} \cdot Z_e \cdot Z_k \cdot b / 100$$

$$Z_e = \frac{Z_k}{180} \cdot \arccos \left[\frac{t \cdot (Z_g - Z_k)}{2 \cdot \pi \cdot A} \right]$$

P = power in kW

M = torque in Nm

P_{spez} = specific power

M_{spez} = specific torque

Z_e = number of teeth in mesh of the small pulley

Z_emax = 12

Z_k = number of teeth of the small pulley

b = belt width in cm

A = centre distance [mm]

t = pitch

Flexibility

Minimum pulley number of teeth and minimum idler diameter			
Drive without reverse bending		Timing pulley Z _{min}	10
		Flat idler running on belt teeth d _{min}	30 mm
Drive with reverse bending		Timing pulley Z _{min}	15
		Flat idler running on belt back d _{min}	30 mm

Minimum available length

Execution	Max width
	4"
Standard	≥ 800 mm
PAZ	≥ 800 mm

ELA-flex SD™

L

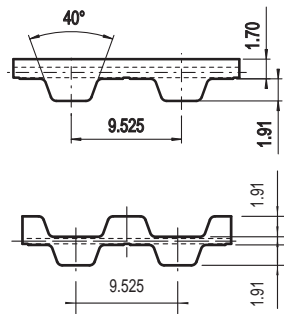
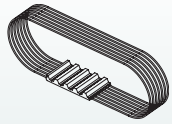

Belt characteristics

- Truly endless polyurethane timing belt with steel tension cords and trapezoidal tooth profile according to DIN/ISO 5296.
- Imperial pitch 3/8" = 9,525 mm
- Mainly used in applications where inch pitch is an advantage
- Transmissible power up to 20 kW
- Rpm up to 10.000 [1/min]
- **Dual toothing available from 1500 mm**

- Maximum width: 150 [mm]
- Width tolerance: ±0,5 [mm]
- Thickness tolerance: ±0,2 [mm]

Technical Data

Belt width [inch]	0,50	0,75	1,00	1,50	2,00	3,00	4,00
Allowable tensile load [N]	1140	1770	2400	3540	4810	7210	9610
Weight [kg/m]	0,05	0,08	0,10	0,15	0,20	0,30	0,40

Other widths are available on request.

Tooth shear strength

rpm [min ⁻¹]	M _{spez} [Ncm/cm]	P _{spez} [W/cm]	rpm [min ⁻¹]	M _{spez} [Ncm/cm]	P _{spez} [W/cm]	rpm [min ⁻¹]	M _{spez} [Ncm/cm]	P _{spez} [W/cm]
0	5,852	0,000	1200	3,393	4,263	3400	2,441	8,689
20	5,673	0,119	1300	3,321	4,521	3600	2,388	9,000
40	5,518	0,231	1400	3,256	4,774	3800	2,336	9,295
60	5,383	0,338	1440	3,230	4,871	4000	2,288	9,581
80	5,266	0,441	1500	3,194	5,017	4500	2,177	10,258
100	5,165	0,541	1600	3,137	5,255	5000	2,077	10,874
200	4,789	1,003	1700	3,082	5,486	5500	1,986	11,437
300	4,516	1,419	1800	3,029	5,709	6000	1,903	11,953
400	4,304	1,803	1900	2,980	5,930	6500	1,827	12,433
500	4,131	2,163	2000	2,933	6,143	7000	1,755	12,867
600	3,984	2,503	2200	2,845	6,555	7500	1,689	13,263
700	3,857	2,827	2400	2,765	6,949	8000	1,627	13,626
800	3,744	3,137	2600	2,692	7,330	8500	1,569	13,965
900	3,644	3,434	2800	2,623	7,689	9000	1,513	14,258
1000	3,553	3,721	3000	2,559	8,039	9500	1,461	14,537
1100	3,470	3,997	3200	2,498	8,371	10000	1,411	14,779

The total power "P" and the total torque "M" transmitted by the belt, are calculated with the following formulas:

$$P \text{ [kW]} = P_{\text{spez}} \cdot Z_e \cdot Z_k \cdot b / 1000$$

$$M \text{ [Nm]} = M_{\text{spez}} \cdot Z_e \cdot Z_k \cdot b / 100$$

$$Z_e = \frac{Z_k}{180} \cdot \arccos \left[\frac{t \cdot (Z_g - Z_k)}{2 \cdot \pi \cdot A} \right]$$

P = power in kW

M = torque in Nm

P_{spez} = specific power

M_{spez} = specific torque

Z_e = number of teeth in mesh of the small pulley

Z_{emax} = 12

Z_k = number of teeth of the small pulley

b = belt width in cm

A = centre distance [mm]

t = pitch

Flexibility

Minimum pulley number of teeth and minimum idler diameter			
Drive without reverse bending		Timing pulley Z _{min}	15
		Flat idler running on belt teeth d _{min}	60 mm
Drive with reverse bending		Timing pulley Z _{min}	20
		Flat idler running on belt back d _{min}	60 mm

Minimum available length

Execution	Max width 4"
Standard	≥ 800 mm
PAZ	≥ 800 mm

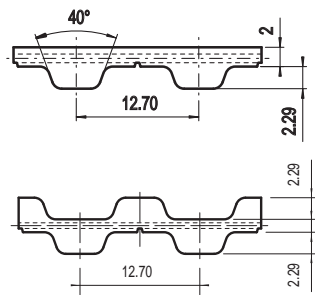
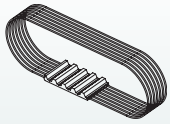
Belt characteristics

- Truly endless polyurethane timing belt with steel tension cords and trapezoidal tooth profile according to DIN/ISO 5296.
- Imperial pitch 1/2" = 12,7 mm
- Allow to use small diameter pulley
- Mainly used in applications where inch pitch is an advantage
- Transmissible power up to 30 kW
- Rpm up to 10.000 [1/min]
- **Dual tothing available from 1500 mm**

- Maximum width: 150 [mm]
- Width tolerance: ±0,5 [mm]
- Thickness tolerance: ±0,2 [mm]

Technical Data

Belt width [inch]	0,50	0,75	1,00	1,50	2,00	3,00	4,00
Allowable tensile load [N]	1140	1770	2400	3540	4810	7210	9610
Weight [kg/m]	0,056	0,084	0,113	0,169	0,225	0,338	0,450

Other widths are available on request.

Tooth shear strength

rpm [min ⁻¹]	M _{spez} [Ncm/cm]	P _{spez} [W/cm]	rpm [min ⁻¹]	M _{spez} [Ncm/cm]	P _{spez} [W/cm]	rpm [min ⁻¹]	M _{spez} [Ncm/cm]	P _{spez} [W/cm]
0	9,156	0,000	1200	5,318	6,682	3400	3,826	13,622
20	8,883	0,186	1300	5,207	7,088	3600	3,741	14,104
40	8,647	0,362	1400	5,104	7,482	3800	3,663	14,573
60	8,443	0,530	1440	5,063	7,635	4000	3,588	15,027
80	8,263	0,692	1500	5,007	7,864	4500	3,412	16,077
100	8,107	0,849	1600	4,916	8,236	5000	3,256	17,049
200	7,523	1,576	1700	4,829	8,596	5500	3,115	17,939
300	7,089	2,227	1800	4,748	8,949	6000	2,983	18,744
400	6,753	2,829	1900	4,671	9,293	6500	2,864	19,494
500	6,478	3,392	2000	4,596	9,626	7000	2,753	20,179
600	6,246	3,924	2200	4,461	10,277	7500	2,650	20,811
700	6,046	4,431	2400	4,334	10,891	8000	2,553	21,385
800	5,870	4,917	2600	4,218	11,485	8500	2,462	21,912
900	5,712	5,383	2800	4,111	12,054	9000	2,375	22,382
1000	5,569	5,831	3000	4,010	12,597	9500	2,294	22,821
1100	5,437	6,263	3200	3,915	13,119	10000	2,215	23,197

The total power "P" and the total torque "M" transmitted by the belt, are calculated with the following formulas:

$$P \text{ [kW]} = P_{\text{spez}} \cdot Z_e \cdot Z_k \cdot b / 1000$$

$$M \text{ [Nm]} = M_{\text{spez}} \cdot Z_e \cdot Z_k \cdot b / 100$$

$$Z_e = \frac{Z_k \cdot \arccos \left[\frac{t \cdot (z_g - z_k)}{2 \cdot \pi \cdot A} \right]}{180}$$

P = power in kW

M = torque in Nm

P_{spez} = specific power

M_{spez} = specific torque

Z_e = number of teeth in mesh of the small pulley

Z_{emax} = 12

Z_k = number of teeth of the small pulley

b = belt width in cm

A = centre distance [mm]

t = pitch

Flexibility

Minimum pulley number of teeth and minimum idler diameter			
Drive without reverse bending		Timing pulley Z _{min}	14
		Flat idler running on belt teeth d _{min}	60 mm
Drive with reverse bending		Timing pulley Z _{min}	20
		Flat idler running on belt back d _{min}	80 mm

Minimum available length

Execution	Max width 4"
Standard	≥ 800 mm
PAZ	≥ 800 mm

ELA-flex SD™

XH

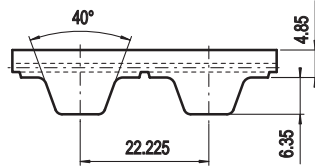
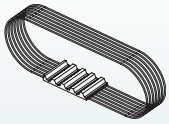

Belt characteristics

- Truly endless polyurethane timing belt with steel tension cords and trapezoidal tooth profile according to DIN/ISO 5296.
- Imperial pitch 7/8" = 22,225 mm
- Mainly used in applications where inch pitch is an advantage
- Transmissible power up to 100 kW
- Rpm up to 4.500 [1/min]

- Maximum width: 150 [mm]
- Width tolerance: ±1,0 [mm]
- Thickness tolerance: ±0,2 [mm]

Technical Data

Belt width [inch]	1,00	2,00	3,00	4,00	6,00
Allowable tensile load [N]	4040	8350	12400	16710	25060
Weight [kg/m]	0,27	0,53	0,80	1,06	1,59

Other widths are available on request.

Tooth shear strength

rpm [min ⁻¹]	M _{spez} [Ncm/cm]	P _{spez} [W/cm]	rpm [min ⁻¹]	M _{spez} [Ncm/cm]	P _{spez} [W/cm]	rpm [min ⁻¹]	M _{spez} [Ncm/cm]	P _{spez} [W/cm]
0	33,957	0,000	1200	17,802	22,369	3400	12,904	43,237
20	32,889	0,689	1300	17,405	23,692	3600	12,599	44,855
40	31,932	1,337	1400	17,037	24,975	3800	12,312	46,411
60	31,074	1,952	1440	16,897	25,477	4000	12,040	47,907
80	30,306	2,539	1500	16,693	26,220	4500	11,782	49,347
100	29,618	3,101	1600	16,372	27,430	-	-	-
200	26,460	5,541	1700	16,070	28,606	-	-	-
300	24,554	7,713	1800	15,785	29,752	-	-	-
400	23,178	9,708	1900	15,515	30,867	-	-	-
500	22,100	11,571	2000	15,259	31,955	-	-	-
600	21,213	13,327	2200	14,782	34,053	-	-	-
700	20,459	14,996	2400	14,347	36,054	-	-	-
800	19,804	16,590	2600	13,946	37,967	-	-	-
900	19,224	18,117	2800	13,574	39,798	-	-	-
1000	18,704	19,586	3000	13,433	40,509	-	-	-
1100	18,233	21,001	3200	13,228	41,553	-	-	-

The total power "P" and the total torque "M" transmitted by the belt, are calculated with the following formulas:

$$P \text{ [kW]} = P_{\text{spez}} \cdot Z_e \cdot Z_k \cdot b / 1000$$

$$M \text{ [Nm]} = M_{\text{spez}} \cdot Z_e \cdot Z_k \cdot b / 100$$

$$Z_e = \frac{Z_k}{180} \cdot \arccos \left[\frac{t \cdot (Z_g - Z_k)}{2 \cdot \pi \cdot A} \right]$$

- P = power in kW
- M = torque in Nm
- P_{spez} = specific power
- M_{spez} = specific torque
- Z_e = number of teeth in mesh of the small pulley
- Z_{emax} = 12
- Z_k = number of teeth of the small pulley
- b = belt width in cm
- A = centre distance [mm]
- t = pitch

Flexibility

Minimum pulley number of teeth and minimum idler diameter			
Drive without reverse bending		Timing pulley Z _{min}	18
		Flat idler running on belt teeth d _{min}	150 mm
Drive with reverse bending		Timing pulley Z _{min}	20
		Flat idler running on belt back d _{min}	180 mm

Minimum available length

Execution	Max width 6"
Standard	≥ 1500 mm
PAZ	≥ 1800 mm

ELA-flex SD™ HTD 5M

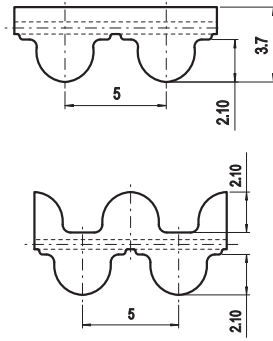
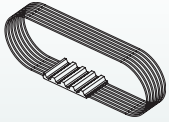

Belt characteristics

- Truly endless polyurethane timing belt with round tooth profile and steel tension cords. Produced according to ISO 13050
- Metric pitch 5 mm
- The round tooth profile allows a uniform load distribution that guarantees high performance, high transmissible torque and precise tooth engagement
- Transmissible power up to 6 kW
- Rpm up to 10.000 [1/min]
- **Dual tothing available from 1500 mm**

- Maximum width: 150 [mm]
- Width tolerance: ±0,5 [mm]
- Thickness tolerance: ±0,2 [mm]

Technical Data

Belt width [mm]	10	15	25	50	100	150
Allowable tensile load [N]	890	1390	2280	4680	9490	14200
Weight [kg/m]	0,05	0,07	0,11	0,23	0,46	0,68

Other widths are available on request.

Tooth shear strength

rpm [min ⁻¹]	M _{spez} [Ncm/cm]	P _{spez} [W/cm]	rpm [min ⁻¹]	M _{spez} [Ncm/cm]	P _{spez} [W/cm]	rpm [min ⁻¹]	M _{spez} [Ncm/cm]	P _{spez} [W/cm]
0	2,928	0,000	1200	1,992	2,503	3400	1,461	5,203
20	2,885	0,060	1300	1,955	2,661	3600	1,430	5,390
40	2,845	0,119	1400	1,920	2,814	3800	1,400	5,570
60	2,809	0,176	1440	1,906	2,875	4000	1,371	5,743
80	2,776	0,233	1500	1,887	2,964	4500	1,305	6,148
100	2,747	0,288	1600	1,855	3,109	5000	1,245	6,517
200	2,637	0,552	1700	1,826	3,250	5500	1,190	6,854
300	2,457	0,772	1800	1,797	3,387	6000	1,140	7,161
400	2,395	1,003	1900	1,770	3,521	6500	1,093	7,440
500	2,333	1,221	2000	1,744	3,652	7000	1,050	7,695
600	2,273	1,428	2200	1,695	3,904	7500	1,009	7,926
700	2,217	1,625	2400	1,649	4,145	8000	0,971	8,135
800	2,166	1,814	2600	1,607	4,375	8500	0,935	8,324
900	2,118	1,996	2800	1,567	4,595	9000	0,901	8,493
1000	2,073	2,170	3000	1,530	4,806	9500	0,869	8,644
1100	2,031	2,339	3200	1,495	5,009	10000	0,838	8,778

The total power "P" and the total torque "M" transmitted by the belt, are calculated with the following formulas:

$$P \text{ [kW]} = P_{\text{spez}} \cdot Z_e \cdot Z_k \cdot b / 1000$$

$$M \text{ [Nm]} = M_{\text{spez}} \cdot Z_e \cdot Z_k \cdot b / 100$$

$$Z_e = \frac{Z_k \cdot \arccos \left[\frac{t \cdot (Z_g - Z_k)}{2 \cdot \pi \cdot A} \right]}{180}$$

P = power in kW

M = torque in Nm

P_{spez} = specific power

M_{spez} = specific torque

Z_e = number of teeth in mesh of the small pulley

Z_{emax} = 12

Z_k = number of teeth of the small pulley

b = belt width in cm

A = centre distance [mm]

t = pitch

Flexibility

Minimum pulley number of teeth and minimum idler diameter			
Drive without reverse bending		Timing pulley Z _{min}	16
		Flat idler running on belt teeth d _{min}	30 mm
Drive with reverse bending		Timing pulley Z _{min}	25
		Flat idler running on belt back d _{min}	60 mm

Minimum available length

Execution	Max width	
	100 mm	150 mm
Standard	≥ 800 mm	≥ 1500 mm
PAZ	≥ 800 mm	≥ 1800 mm

ELA-flex SD™ HTD 8M

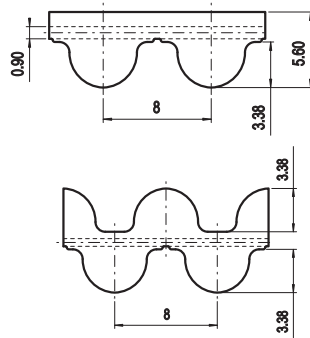
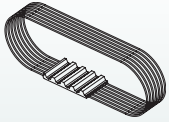

Belt characteristics

- Truly endless polyurethane timing belt with round tooth profile and steel tension cords. Produced according to ISO 13050
- Metric pitch 8 mm
- The round tooth profile allows a uniform load distribution that guarantees high performance, high transmissible torque and precise tooth engagement
- Transmissible power up to 80 kW
- Rpm up to 6.000 [1/min]
- **Dual tothing available from 1500 mm**

- Maximum width: 150 [mm]
- Width tolerance: ±0,5 [mm]
- Thickness tolerance: ±0,2 [mm]

Technical Data

Belt width [mm]	10	15	20	30	50	85	100	150
Allowable tensile load [N]	1620	2430	3230	4850	8090	14000	16440	24600
Weight [kg/m]	0,07	0,10	0,13	0,20	0,33	0,56	0,66	1,00

Other widths are available on request.

Tooth shear strength

rpm [min ⁻¹]	M _{spez} [Ncm/cm]	P _{spez} [W/cm]	rpm [min ⁻¹]	M _{spez} [Ncm/cm]	P _{spez} [W/cm]	rpm [min ⁻¹]	M _{spez} [Ncm/cm]	P _{spez} [W/cm]
0	9,422	0,000	1200	5,848	7,348	3400	3,936	14,013
20	9,246	0,194	1300	5,709	7,772	3600	3,826	14,421
40	9,083	0,380	1400	5,580	8,180	3800	3,721	14,805
60	8,933	0,561	1440	5,530	8,338	4000	3,621	15,166
80	8,794	0,737	1500	5,458	8,572	4500	3,390	15,975
100	8,666	0,907	1600	5,343	8,951	5000	3,183	16,663
200	8,160	1,709	1700	5,233	9,316	5500	2,994	17,241
300	7,853	2,467	1800	5,130	9,669	6000	2,821	17,720
400	7,516	3,148	1900	5,031	10,010	-	-	-
500	7,220	3,780	2000	4,937	10,340	-	-	-
600	6,959	4,372	2200	4,761	10,968	-	-	-
700	6,728	4,931	2400	4,599	11,557	-	-	-
800	6,519	5,461	2600	4,448	12,110	-	-	-
900	6,330	5,965	2800	4,308	12,630	-	-	-
1000	6,156	6,446	3000	4,176	13,119	-	-	-
1100	5,996	6,907	3200	4,053	13,580	-	-	-

The total power "P" and the total torque "M" transmitted by the belt, are calculated with the following formulas:

$$P \text{ [kW]} = P_{\text{spez}} \cdot Z_e \cdot Z_k \cdot b / 1000$$

$$M \text{ [Nm]} = M_{\text{spez}} \cdot Z_e \cdot Z_k \cdot b / 100$$

$$Z_e = \frac{Z_k \cdot \arccos\left[\frac{t \cdot (z_g - z_k)}{2 \cdot \pi \cdot A}\right]}{180}$$

P = power in kW

M = torque in Nm

P_{spez} = specific power

M_{spez} = specific torque

Z_e = number of teeth in mesh of the small pulley

Z_{emax} = 12

Z_k = number of teeth of the small pulley

b = belt width in cm

A = centre distance [mm]

t = pitch

Flexibility

Minimum pulley number of teeth and minimum idler diameter			
Drive without reverse bending		Timing pulley Z _{min}	18
		Flat idler running on belt teeth d _{min}	50 mm
Drive with reverse bending		Timing pulley Z _{min}	30
		Flat idler running on belt back d _{min}	120 mm

Minimum available length

Execution	Max width	
	100 mm	150 mm
Standard	≥ 800 mm	≥ 1500 mm
PAZ	≥ 800 mm	≥ 1800 mm

ELA-flex SD™ HTD 14M

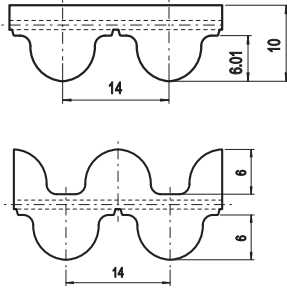
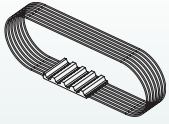

Belt characteristics

- Truly endless polyurethane timing belt with round tooth profile and steel tension cords. Produced according to ISO 13050
- Metric pitch 14 mm
- The round tooth profile allows a uniform load distribution that guarantees high performance, high transmissible torque and precise tooth engagement
- Transmissible power up to 200 kW
- Rpm up to 4.000 [1/min]
- **Dual toothing available from 1500 mm**

- Maximum width: 150 [mm]
- Width tolerance: ±1,0 [mm]
- Thickness tolerance: ±0,2 [mm]

Technical Data

Belt width [mm]	40	55	85	115	150
Allowable tensile load [N]	9500	13200	20590	27980	36960
Weight [kg/m]	0,42	0,57	0,89	1,24	1,70

Other widths are available on request.

Tooth shear strength

rpm [min ⁻¹]	M _{spez} [Ncm/cm]	P _{spez} [W/cm]	rpm [min ⁻¹]	M _{spez} [Ncm/cm]	P _{spez} [W/cm]	rpm [min ⁻¹]	M _{spez} [Ncm/cm]	P _{spez} [W/cm]
0	28,966	0,000	1200	16,335	20,526	3400	9,630	34,286
20	28,452	0,596	1300	15,852	21,578	3600	9,242	34,837
40	27,978	1,172	1400	15,398	22,573	3800	8,872	35,303
60	27,540	1,730	1440	15,225	22,957	4000	8,521	35,688
80	27,136	2,273	1500	14,972	23,516	-	-	-
100	26,762	2,802	1600	14,569	24,408	-	-	-
200	24,458	5,122	1700	14,187	25,254	-	-	-
300	23,239	7,300	1800	13,824	26,056	-	-	-
400	22,100	9,257	1900	13,478	26,816	-	-	-
500	21,091	11,042	2000	13,148	27,536	-	-	-
600	20,195	12,688	2200	12,530	28,865	-	-	-
700	19,394	14,216	2400	11,960	30,056	-	-	-
800	18,672	15,641	2600	11,431	31,121	-	-	-
900	18,014	16,976	2800	10,938	32,069	-	-	-
1000	17,410	18,230	3000	10,476	32,908	-	-	-
1100	16,853	19,411	3200	10,041	33,645	-	-	-

The total power "P" and the total torque "M" transmitted by the belt, are calculated with the following formulas:

$$P \text{ [kW]} = P_{\text{spez}} \cdot Z_e \cdot Z_k \cdot b / 1000$$

$$M \text{ [Nm]} = M_{\text{spez}} \cdot Z_e \cdot Z_k \cdot b / 100$$

$$Z_e = \frac{Z_k}{180} \cdot \arccos \left[\frac{t \cdot (Z_g - Z_k)}{2 \cdot \pi \cdot A} \right]$$

P = power in kW

M = torque in Nm

P_{spez} = specific power

M_{spez} = specific torque

Z_e = number of teeth in mesh of the small pulley

Z_{emax} = 12

Z_k = number of teeth of the small pulley

b = belt width in cm

A = centre distance [mm]

t = pitch

Flexibility

Minimum pulley number of teeth and minimum idler diameter			
Drive without reverse bending		Timing pulley Z _{min}	28
		Flat idler running on belt teeth d _{min}	120 mm
Drive with reverse bending		Timing pulley Z _{min}	28
		Flat idler running on belt back d _{min}	180 mm

Minimum available length

Execution	Max width 150 mm
Standard	≥ 1500 mm
PAZ	≥ 1800 mm

ELA-flex SD™ RTD 5M

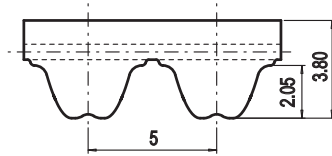
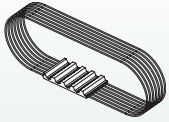

Belt characteristics

- Truly endless polyurethane timing belt with round tooth profile and steel tension cords. Produced according to ISO 13050
- Metric pitch 5 mm
- PAZ fabric on tooth delivered as standard decreases noise in high speed drives
- Transmissible power up to 6 kW
- Rpm up to 10.000 [1/min]

- Maximum width: 150 [mm]
- Width tolerance: ±0,5 [mm]
- Thickness tolerance: ±0,2 [mm]

Technical Data

Belt width [mm]	10	15	25	50	100
Allowable tensile load [N]	890	1390	2280	4680	9490
Weight [kg/m]	0,05	0,07	0,11	0,23	0,46

Other widths are available on request.

Tooth shear strength

rpm [min ⁻¹]	M _{spez} [Ncm/cm]	P _{spez} [W/cm]	rpm [min ⁻¹]	M _{spez} [Ncm/cm]	P _{spez} [W/cm]	rpm [min ⁻¹]	M _{spez} [Ncm/cm]	P _{spez} [W/cm]
0	3,01	0,000	1200	2,15	2,703	3400	1,62	5,770
20	2,96	0,062	1300	2,11	2,878	3600	1,59	5,990
40	2,92	0,122	1400	2,08	3,048	3800	1,56	6,203
60	2,89	0,181	1440	2,07	3,115	4000	1,53	6,410
80	2,86	0,239	1500	2,05	3,214	4500	1,46	6,898
100	2,83	0,296	1600	2,01	3,375	5000	1,40	7,351
200	2,72	0,569	1700	1,98	3,533	5500	1,35	7,770
300	2,62	0,822	1800	1,96	3,687	6000	1,30	8,161
400	2,55	1,070	1900	1,93	3,838	6500	1,25	8,524
500	2,49	1,305	2000	1,90	3,985	7000	1,21	8,861
600	2,43	1,528	2200	1,85	4,271	7500	1,17	9,176
700	2,38	1,742	2400	1,81	4,545	8000	1,13	9,468
800	2,32	1,947	2600	1,77	4,808	8500	1,09	9,740
900	2,28	2,146	2800	1,73	5,062	9000	1,06	9,993
1000	2,23	2,337	3000	1,69	5,306	9500	1,03	10,228
1100	2,19	2,523	3200	1,65	5,542	10000	1,00	10,445

The total power "P" and the total torque "M" transmitted by the belt, are calculated with the following formulas:

$$P \text{ [kW]} = P_{\text{spez}} \cdot Z_e \cdot Z_k \cdot b / 1000$$

$$M \text{ [Nm]} = M_{\text{spez}} \cdot Z_e \cdot Z_k \cdot b / 100$$

$$Z_e = \frac{Z_k \cdot \arccos \left[\frac{t \cdot (z_g - z_k)}{2 \cdot \pi \cdot A} \right]}{180}$$

P = power in kW

M = torque in Nm

P_{spez} = specific power

M_{spez} = specific torque

Z_e = number of teeth in mesh of the small pulley

Z_{emax} = 12

Z_k = number of teeth of the small pulley

b = belt width in cm

A = centre distance [mm]

t = pitch

Flexibility

Minimum pulley number of teeth and minimum idler diameter			
Drive without reverse bending		Timing pulley Z _{min}	16
		Flat idler running on belt teeth d _{min}	30 mm
Drive with reverse bending		Timing pulley Z _{min}	25
		Flat idler running on belt back d _{min}	60 mm

Minimum available length

Execution	Max width 100 mm
Standard	≥ 1500 mm
PAZ	≥ 1800 mm

ELA-flex SD™ RTD 8M

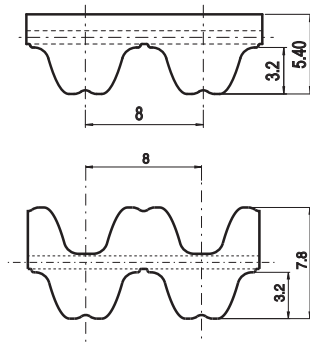
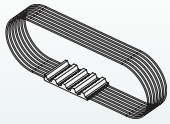

Belt characteristics

- Truly endless polyurethane timing belt with round tooth profile and steel tension cords. Produced according to ISO 13050
- Metric pitch 8 mm
- PAZ fabric on tooth delivered as standard decreases noise in high speed drives
- Transmissible power up to 80 kW
- Rpm up to 6.000 [1/min]
- **Dual tothing available from 1500 mm**

- Maximum width: 150 [mm]
- Width tolerance: ±0,5 [mm]
- Thickness tolerance: ±0,2 [mm]

Technical Data

Belt width [mm]	10	15	20	30	50	85	100	150
Allowable tensile load [N]	1620	2430	3230	4850	8090	14100	16440	24600
Weight [kg/m]	0,07	0,10	0,13	0,20	0,33	0,56	0,66	1,00

Other widths are available on request.

Tooth shear strength

rpm [min ⁻¹]	M _{spez} [Ncm/cm]	P _{spez} [W/cm]	rpm [min ⁻¹]	M _{spez} [Ncm/cm]	P _{spez} [W/cm]	rpm [min ⁻¹]	M _{spez} [Ncm/cm]	P _{spez} [W/cm]
0	9,68	0,000	1200	6,10	7,668	3400	4,19	14,920
20	9,50	0,199	1300	5,96	8,118	3600	4,08	15,381
40	9,34	0,391	1400	5,83	8,553	3800	3,98	15,818
60	9,19	0,577	1440	5,78	8,722	4000	3,88	16,232
80	9,05	0,758	1500	5,71	8,972	4500	3,64	17,175
100	8,92	0,934	1600	5,60	9,377	5000	3,44	17,996
200	8,41	1,762	1700	5,49	9,769	5500	3,25	18,708
300	8,11	2,547	1800	5,38	10,149	6000	3,08	19,320
400	7,77	3,255	1900	5,29	10,517	-	-	-
500	7,47	3,913	2000	5,19	10,873	-	-	-
600	7,21	4,532	2200	5,02	11,554	-	-	-
700	6,98	5,118	2400	4,85	12,197	-	-	-
800	6,77	5,674	2600	4,70	12,803	-	-	-
900	6,58	6,205	2800	4,56	13,377	-	-	-
1000	6,41	6,713	3000	4,43	13,919	-	-	-
1100	6,25	7,200	3200	4,31	14,433	-	-	-

The total power "P" and the total torque "M" transmitted by the belt, are calculated with the following formulas:

$$P \text{ [kW]} = P_{\text{spez}} \cdot Z_e \cdot Z_k \cdot b / 1000$$

$$M \text{ [Nm]} = M_{\text{spez}} \cdot Z_e \cdot Z_k \cdot b / 100$$

$$Z_e = \frac{Z_k}{180} \cdot \arccos \left[\frac{t \cdot (Z_g - Z_k)}{2 \cdot \pi \cdot A} \right]$$

P = power in kW

M = torque in Nm

P_{spez} = specific power

M_{spez} = specific torque

Z_e = number of teeth in mesh of the small pulley

Z_{emax} = 12

Z_k = number of teeth of the small pulley

b = belt width in cm

A = centre distance [mm]

t = pitch

Flexibility

Minimum pulley number of teeth and minimum idler diameter			
Drive without reverse bending		Timing pulley Z _{min}	18
		Flat idler running on belt teeth d _{min}	50 mm
Drive with reverse bending		Timing pulley Z _{min}	30
		Flat idler running on belt back d _{min}	120 mm

Minimum available length

Execution	Max width	
	100 mm	150 mm
Standard	≥ 800 mm	≥ 1500 mm
PAZ	≥ 800 mm	≥ 1800 mm

ELA-flex SD™ RTD 14M

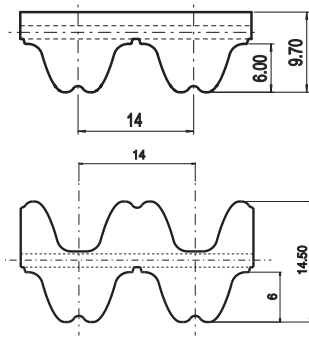
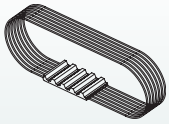

Belt characteristics

- Truly endless polyurethane timing belt with round tooth profile and steel tension cords. Produced according to ISO 13050
- Metric pitch 14 mm
- PAZ fabric on tooth delivered as standard decreases noise in high speed drives
- Transmissible power up to 200 kW
- Rpm up to 4.000 [1/min]
- **Dual tothing available from 1500 mm**

- Maximum width: 150 [mm]
- Width tolerance: ±1,0 [mm]
- Thickness tolerance: ±0,2 [mm]

Technical Data

Belt width [mm]	40	55	85	115	150
Allowable tensile load [N]	14960	20570	31790	43010	56000
Weight [kg/m]	0,48	0,63	1,0	1,40	1,85

Other widths are available on request.

Tooth shear strength

rpm [min ⁻¹]	M _{spez} [Ncm/cm]	P _{spez} [W/cm]	rpm [min ⁻¹]	M _{spez} [Ncm/cm]	P _{spez} [W/cm]	rpm [min ⁻¹]	M _{spez} [Ncm/cm]	P _{spez} [W/cm]
0	31,19	0,000	1200	18,56	23,325	3400	11,86	42,219
20	30,59	0,641	1300	18,08	24,611	3600	11,47	43,237
40	30,04	1,258	1400	17,63	25,840	3800	11,10	44,169
60	29,53	1,855	1440	17,45	26,316	4000	10,75	45,021
80	29,06	2,434	1500	17,20	27,016	-	-	-
100	28,62	2,997	1600	16,80	28,141	-	-	-
200	26,69	5,589	1700	16,42	29,220	-	-	-
300	25,47	8,000	1800	16,05	30,255	-	-	-
400	24,33	10,190	1900	15,71	31,249	-	-	-
500	23,32	12,209	2000	15,38	32,202	-	-	-
600	22,42	14,088	2200	14,76	33,998	-	-	-
700	21,62	15,849	2400	14,19	35,656	-	-	-
800	20,90	17,508	2600	13,66	37,187	-	-	-
900	20,24	19,076	2800	13,17	38,602	-	-	-
1000	19,64	20,564	3000	12,70	39,907	-	-	-
1100	19,08	21,978	3200	12,27	41,111	-	-	-

The total power "P" and the total torque "M" transmitted by the belt, are calculated with the following formulas:

$$P \text{ [kW]} = P_{\text{spez}} \cdot Z_e \cdot Z_k \cdot b / 1000$$

$$M \text{ [Nm]} = M_{\text{spez}} \cdot Z_e \cdot Z_k \cdot b / 100$$

$$Z_e = \frac{Z_k}{180} \cdot \arccos \left[\frac{t \cdot (Z_g - Z_k)}{2 \cdot \pi \cdot A} \right]$$

P = power in kW

M = torque in Nm

P_{spez} = specific power

M_{spez} = specific torque

Z_e = number of teeth in mesh of the small pulley

Z_{emax} = 12

Z_k = number of teeth of the small pulley

b = belt width in cm

A = centre distance [mm]

t = pitch

Flexibility

Minimum pulley number of teeth and minimum idler diameter			
Drive without reverse bending		Timing pulley Z _{min}	32
		Flat idler running on belt teeth d _{min}	140 mm
Drive with reverse bending		Timing pulley Z _{min}	32
		Flat idler running on belt back d _{min}	200 mm

Minimum available length

Execution	Max width 150 mm
Standard	≥ 1500 mm
PAZ	≥ 1800 mm

ELA-flex SD™ STD 5M

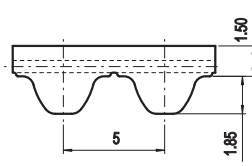
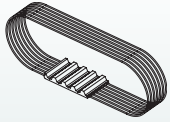

Belt characteristics

- Truly endless polyurethane timing belt with high tensile load steel cords and high torque capacity - produced according to ISO 13050
- Metric pitch 5 mm
- Low noise generation in high speed drives
- Offer excellent operational reliability
- The special profile allows smooth running properties
- Transmissible power up to 6 Kw
- Rpm up to 10.000 [1/min]

- Maximum width: 150 [mm]
- Width tolerance: ±0,5 [mm]
- Thickness tolerance: ±0,2 [mm]

Technical Data

Belt width [mm]	10	15	25	50	100	150
Allowable tensile load [N]	890	1390	2280	4680	9490	28470
Weight [kg/m]	0,046	0,068	0,114	0,228	0,456	1,368

Other widths are available on request.

Tooth shear strength

rpm [min ⁻¹]	M _{spez} [Ncm/cm]	P _{spez} [W/cm]	rpm [min ⁻¹]	M _{spez} [Ncm/cm]	P _{spez} [W/cm]	rpm [min ⁻¹]	M _{spez} [Ncm/cm]	P _{spez} [W/cm]
0	2,936	0,000	1200	2,031	2,553	3400	1,501	5,345
20	2,892	0,061	1300	1,995	2,715	3600	1,470	5,540
40	2,853	0,119	1400	1,960	2,873	3800	1,440	5,728
60	2,817	0,177	1440	1,946	2,935	4000	1,411	5,910
80	2,784	0,233	1500	1,927	3,026	4500	1,345	6,336
100	2,755	0,288	1600	1,895	3,175	5000	1,285	6,726
200	2,645	0,554	1700	1,865	3,321	5500	1,230	7,083
300	2,497	0,784	1800	1,837	3,462	6000	1,180	7,411
400	2,435	1,020	1900	1,810	3,600	6500	1,133	7,711
500	2,372	1,242	2000	1,784	3,735	7000	1,090	7,987
600	2,313	1,453	2200	1,734	3,996	7500	1,049	8,238
700	2,257	1,654	2400	1,689	4,245	8000	1,011	8,469
800	2,205	1,847	2600	1,647	4,483	8500	0,975	8,678
900	2,157	2,033	2800	1,607	4,712	9000	0,941	8,868
1000	2,113	2,212	3000	1,570	4,931	9500	0,909	9,040
1100	2,071	2,385	3200	1,535	5,142	10000	0,878	9,195

The total power "P" and the total torque "M" transmitted by the belt, are calculated with the following formulas:

$$P \text{ [kW]} = P_{\text{spez}} \cdot Z_e \cdot Z_k \cdot b / 1000$$

$$M \text{ [Nm]} = M_{\text{spez}} \cdot Z_e \cdot Z_k \cdot b / 100$$

$$Z_e = \frac{Z_k \cdot \arccos \left[\frac{t \cdot (Z_g - Z_k)}{2 \cdot \pi \cdot A} \right]}{180}$$

P = power in kW

M = torque in Nm

P_{spez} = specific power

M_{spez} = specific torque

Z_e = number of teeth in mesh of the small pulley

Z_{emax} = 12

Z_k = number of teeth of the small pulley

b = belt width in cm

A = centre distance [mm]

t = pitch

Flexibility

Minimum pulley number of teeth and minimum idler diameter			
Drive without reverse bending		Timing pulley Z _{min}	16
		Flat idler running on belt teeth d _{min}	30 mm
Drive with reverse bending		Timing pulley Z _{min}	25
		Flat idler running on belt back d _{min}	60 mm

Minimum available length

Execution	Max width	
	100 mm	150 mm
Standard	≥ 800 mm	≥ 1500 mm
PAZ	≥ 800 mm	≥ 1800 mm

ELA-flex SD™ STD 8M

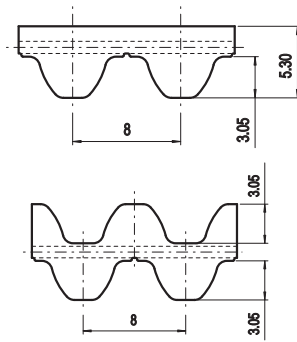
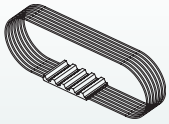

Belt characteristics

- Truly endless polyurethane timing belt with high tensile load steel cords and high torque capacity - produced according to ISO 13050
- Metric pitch 8 mm
- Low noise generation in high speed drives
- Offer excellent operational reliability
- The special profile allows smooth running properties
- Transmissible power up to 80 Kw
- Rpm up to 6.000 [1/min]
- **Dual toothing available from 1500 mm**

- Maximum width: 150 [mm]
- Width tolerance: ±0,5 [mm]
- Thickness tolerance: ±0,2 [mm]

Technical Data

Belt width [mm]	10	15	20	30	50	85	100	150
Allowable tensile load [N]	1620	2430	3230	4850	8090	14000	16400	24600
Weight [kg/m]	0,07	0,10	0,13	0,20	0,33	0,56	0,66	1,00

Other widths are available on request.

Tooth shear strength

rpm [min ⁻¹]	M _{spez} [Ncm/cm]	P _{spez} [W/cm]	rpm [min ⁻¹]	M _{spez} [Ncm/cm]	P _{spez} [W/cm]	rpm [min ⁻¹]	M _{spez} [Ncm/cm]	P _{spez} [W/cm]
0	9,435	0,000	1200	5,885	7,394	3400	3,960	14,098
20	9,301	0,195	1300	5,745	7,821	3600	3,849	14,508
40	9,176	0,384	1400	5,615	8,231	3800	3,743	14,894
60	9,057	0,569	1440	5,565	8,391	4000	3,643	15,257
80	8,946	0,749	1500	5,492	8,626	4500	3,410	16,070
100	8,841	0,926	1600	5,376	9,007	5000	3,201	16,762
200	8,401	1,759	1700	5,266	9,374	5500	3,011	17,343
300	7,908	2,484	1800	5,162	9,729	6000	2,837	17,824
400	7,567	3,169	1900	5,063	10,072	-	-	-
500	7,268	3,805	2000	4,968	10,404	-	-	-
600	7,005	4,401	2200	4,790	11,035	-	-	-
700	6,772	4,963	2400	4,627	11,628	-	-	-
800	6,561	5,496	2600	4,475	12,184	-	-	-
900	6,370	6,003	2800	4,334	12,707	-	-	-
1000	6,195	6,487	3000	4,202	13,199	-	-	-
1100	6,034	6,950	3200	4,077	13,662	-	-	-

The total power "P" and the total torque "M" transmitted by the belt, are calculated with the following formulas:

$$P \text{ [kW]} = P_{\text{spez}} \cdot Z_e \cdot Z_k \cdot b / 1000$$

$$M \text{ [Nm]} = M_{\text{spez}} \cdot Z_e \cdot Z_k \cdot b / 100$$

$$Z_e = \frac{Z_k \cdot \arccos\left[\frac{t \cdot (Z_g - Z_k)}{2 \cdot \pi \cdot A}\right]}{180}$$

- P = power in kW
- M = torque in Nm
- P_{spez} = specific power
- M_{spez} = specific torque
- Z_e = number of teeth in mesh of the small pulley
- Z_{emax} = 12
- Z_k = number of teeth of the small pulley
- b = belt width in cm
- A = centre distance [mm]
- t = pitch

Flexibility

Minimum pulley number of teeth and minimum idler diameter			
Drive without reverse bending		Timing pulley Z _{min}	18
		Flat idler running on belt teeth d _{min}	50 mm
Drive with reverse bending		Timing pulley Z _{min}	30
		Flat idler running on belt back d _{min}	120 mm

Minimum available length

Execution	Max width 150 mm
Standard	≥ 1500 mm
PAZ	≥ 1800 mm

ELA-flex SD™ STD 14M

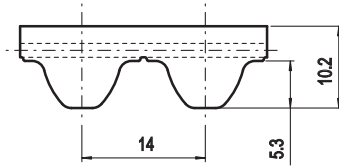
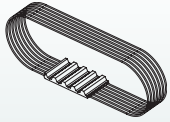

Belt characteristics

- Truly endless polyurethane timing belt with high tensile load steel cords and high torque capacity - produced according to ISO 13050
- Metric pitch 14 mm
- Low noise generation in high speed drives
- Offer excellent operational reliability
- The special profile allows smooth running properties
- Transmissible power up to 200 Kw
- Rpm up to 4.000 [1/min]

- Maximum width: 150 [mm]
- Width tolerance: ±0,5 [mm]
- Thickness tolerance: ±0,2 [mm]

Technical Data

Belt width [mm]	40	55	85	100
Allowable tensile load [N]	14960	20570	31790	37400
Weight [kg/m]	0,48	0,85	1,10	1,54

Other widths are available on request.

Tooth shear strength

rpm [min ⁻¹]	M _{spez} [Ncm/cm]	P _{spez} [W/cm]	rpm [min ⁻¹]	M _{spez} [Ncm/cm]	P _{spez} [W/cm]	rpm [min ⁻¹]	M _{spez} [Ncm/cm]	P _{spez} [W/cm]
0	29,86	0,000	1200	17,45	21,925	3400	10,74	38,252
20	29,26	0,613	1300	16,97	23,095	3600	10,36	39,037
40	28,70	1,202	1400	16,51	24,207	3800	9,99	39,736
60	28,19	1,771	1440	16,34	24,636	4000	9,63	40,354
80	27,72	2,322	1500	16,09	25,266	-	-	-
100	27,29	2,857	1600	15,68	26,275	-	-	-
200	25,57	5,355	1700	15,30	27,237	-	-	-
300	24,35	7,650	1800	14,94	28,156	-	-	-
400	23,21	9,723	1900	14,59	29,032	-	-	-
500	22,20	11,626	2000	14,26	29,869	-	-	-
600	21,31	13,388	2200	13,64	31,431	-	-	-
700	20,51	15,032	2400	13,07	32,856	-	-	-
800	19,79	16,575	2600	12,55	34,154	-	-	-
900	19,13	18,026	2800	12,05	35,335	-	-	-
1000	18,52	19,397	3000	11,59	36,408	-	-	-
1100	17,97	20,695	3200	11,15	37,378	-	-	-

The total power "P" and the total torque "M" transmitted by the belt, are calculated with the following formulas:

$$P \text{ [kW]} = P_{\text{spez}} \cdot Z_e \cdot Z_k \cdot b / 1000$$

$$M \text{ [Nm]} = M_{\text{spez}} \cdot Z_e \cdot Z_k \cdot b / 100$$

$$Z_e = \frac{Z_k \cdot \arccos \left[\frac{t \cdot (Z_g - Z_k)}{2 \cdot \pi \cdot A} \right]}{180}$$

P = power in kW

M = torque in Nm

P_{spez} = specific power

M_{spez} = specific torque

Z_e = number of teeth in mesh of the small pulley

Z_{emax} = 12

Z_k = number of teeth of the small pulley

b = belt width in cm

A = centre distance [mm]

t = pitch

Flexibility

Minimum pulley number of teeth and minimum idler diameter			
Drive without reverse bending		Timing pulley Z _{min}	28
		Flat idler running on belt teeth d _{min}	120 mm
Drive with reverse bending		Timing pulley Z _{min}	28
		Flat idler running on belt back d _{min}	180 mm

Minimum available length

Execution	Max width 100 mm
Standard	≥ 1500 mm
PAZ	≥ 1800 mm

ELA-flex SD™ EAGLE 5M

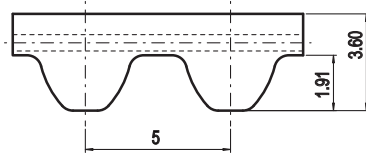

Belt characteristics

- Truly endless polyurethane timing belt with helical offset tooth, high tensile load steel cords and high torque capacity
- **Self tracking no need of pulley flanges**
- Metric pitch 5 mm
- **Extremely reduced noise generation**
- The special profile allows most compact drive
- **Max. length 2500 mm**

- Width tolerance: ±0,8 [mm]
- Thickness tolerance: ±0,2 [mm]

Technical Data

Belt width [mm]	12,5	25
Allowable tensile load [N]	1150	2530
Weight [kg/m]	0,06	0,12

Other widths are available on request.

Tooth shear strength

rpm [min ⁻¹]	M _{spez} [Ncm/cm]	P _{spez} [W/cm]	rpm [min ⁻¹]	M _{spez} [Ncm/cm]	P _{spez} [W/cm]	rpm [min ⁻¹]	M _{spez} [Ncm/cm]	P _{spez} [W/cm]
0	3,01	0,000	1200	2,15	2,702	3400	1,62	5,768
20	2,96	0,062	1300	2,11	2,872	3600	1,59	5,994
40	2,92	0,122	1400	2,08	3,049	3800	1,56	6,208
60	2,89	0,182	1440	2,07	3,121	4000	1,53	6,409
80	2,86	0,240	1500	2,05	3,220	4500	1,46	6,880
100	2,83	0,296	1600	2,01	3,368	5000	1,40	7,330
200	2,72	0,570	1700	1,98	3,525	5500	1,35	7,775
300	2,62	0,823	1800	1,96	3,695	6000	1,30	8,168
400	2,55	1,068	1900	1,93	3,840	6500	1,25	8,508
500	2,49	1,304	2000	1,90	3,979	-	-	-
600	2,43	1,527	2200	1,85	4,262	-	-	-
700	2,38	1,745	2400	1,81	4,549	-	-	-
800	2,32	1,944	2600	1,77	4,819	-	-	-
900	2,28	2,149	2800	1,73	5,073	-	-	-
1000	2,23	2,335	3000	1,69	5,372	-	-	-
1100	2,19	2,523	3200	1,65	5,663	-	-	-

The total power "P" and the total torque "M" transmitted by the belt, are calculated with the following formulas:

$$P \text{ [kW]} = P_{\text{spez}} \cdot Z_e \cdot Z_k \cdot b / 1000$$

$$M \text{ [Nm]} = M_{\text{spez}} \cdot Z_e \cdot Z_k \cdot b / 100$$

$$Z_e = \frac{Z_k}{180} \cdot \arccos \left[\frac{t \cdot (z_g - z_k)}{2 \cdot \pi \cdot A} \right]$$

P = power in kW

M = torque in Nm

P_{spez} = specific power

M_{spez} = specific torque

Z_e = number of teeth in mesh of the small pulley

Z_{emax} = 12

Z_k = number of teeth of the small pulley

b = belt width in cm

A = centre distance [mm]

t = pitch

Flexibility

Minimum pulley number of teeth and minimum idler diameter			
Drive without reverse bending		Timing pulley Z _{min}	16
		Flat idler running on belt teeth d _{min}	30 mm
Drive with reverse bending		Timing pulley Z _{min}	25
		Flat idler running on belt back d _{min}	60 mm

Minimum available length

Execution	Max width 25 mm
Standard	≥ 800 mm
PAZ	≥ 800 mm

ELA-flex SD™ EAGLE 8M

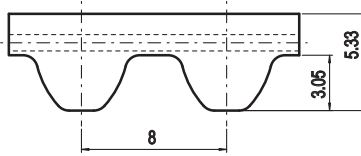

Belt characteristics

- Truly endless polyurethane timing belt with helical offset tooth, high tensile load steel cords and high torque capacity
- **Self tracking no need of pulley flanges**
- Metric pitch 8 mm
- **Extremely reduced noise generation**
- The special profile allows most compact drive

- Width tolerance: $\pm 0,8$ [mm]
- Thickness tolerance: $\pm 0,3$ [mm]

Technical Data

Belt width [mm]	16	25	32	50
Allowable tensile load [N]	2430	4040	5120	8090
Weight [kg/m]	0,085	0,145	0,180	0,300

Other widths are available on request.

Tooth shear strength

rpm [min ⁻¹]	M _{spez} [Ncm/cm]	P _{spez} [W/cm]	rpm [min ⁻¹]	M _{spez} [Ncm/cm]	P _{spez} [W/cm]	rpm [min ⁻¹]	M _{spez} [Ncm/cm]	P _{spez} [W/cm]
0	10,82	0,000	1200	6,87	8,631	3400	4,90	16,422
20	10,67	0,223	1300	6,72	9,146	3600	4,77	16,991
40	10,52	0,441	1400	6,58	9,642	3800	4,65	17,531
60	10,38	0,652	1440	6,52	9,836	4000	4,53	18,044
80	10,24	0,858	1500	6,44	10,122	4500	4,42	18,531
100	10,11	1,058	1600	6,32	10,585	5000	4,17	19,647
200	9,52	1,994	1700	6,20	11,035	5500	3,94	20,627
300	9,04	2,840	1800	6,09	11,470	6000	3,73	21,486
400	8,65	3,623	1900	5,98	11,892	6500	3,54	22,234
500	8,34	4,368	2000	5,87	12,302	-	-	-
600	8,07	5,068	2200	5,68	13,087	-	-	-
700	7,82	5,732	2400	5,50	13,828	-	-	-
800	7,60	6,363	2600	5,34	14,529	-	-	-
900	7,39	6,966	2800	5,18	15,194	-	-	-
1000	7,20	7,543	3000	5,12	15,450	-	-	-
1100	7,03	8,098	3200	5,04	15,824	-	-	-

The total power "P" and the total torque "M" transmitted by the belt, are calculated with the following formulas:

$$P \text{ [kW]} = P_{\text{spez}} \cdot Z_e \cdot Z_k \cdot b / 1000$$

$$M \text{ [Nm]} = M_{\text{spez}} \cdot Z_e \cdot Z_k \cdot b / 100$$

$$Z_e = \frac{Z_k}{180} \cdot \arccos \left[\frac{t \cdot (Z_g - Z_k)}{2 \cdot \pi \cdot A} \right]$$

P = power in kW

M = torque in Nm

P_{spez} = specific power

M_{spez} = specific torque

Z_e = number of teeth in mesh of the small pulley

Z_{emax} = 12

Z_k = number of teeth of the small pulley

b = belt width in cm

A = centre distance [mm]

t = pitch

Flexibility

Minimum pulley number of teeth and minimum idler diameter			
Drive without reverse bending		Timing pulley Z _{min}	20
		Flat idler running on belt teeth d _{min}	50 mm
Drive with reverse bending		Timing pulley Z _{min}	30
		Flat idler running on belt back d _{min}	120 mm

Minimum available length

Execution	Max width 50 mm
Standard	≥ 900 mm
PAZ	≥ 900 mm

ELA-flex SD™ EAGLE 10M

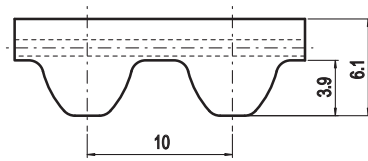

Belt characteristics

- Truly endless polyurethane timing belt with helical offset tooth, high tensile load steel cords and high torque capacity
- **Self tracking no need of pulley flanges**
- Metric pitch 10 mm
- **Extremely reduced noise generation**
- The special profile allows most compact drive
- **Max. length 2500 mm**

- Width tolerance: ±0,8 [mm]
- Thickness tolerance: ±0,3 [mm]

Technical Data

Belt width [mm]	25	32	50
Allowable tensile load [N]	5810	7920	12140
Weight [kg/m]	0,18	0,23	0,37

Other widths are available on request.

Tooth shear strength

rpm [min ⁻¹]	M _{spez} [Ncm/cm]	P _{spez} [W/cm]	rpm [min ⁻¹]	M _{spez} [Ncm/cm]	P _{spez} [W/cm]	rpm [min ⁻¹]	M _{spez} [Ncm/cm]	P _{spez} [W/cm]
0	14,881	0,000	1200	9,273	11,653	3400	6,443	22,937
20	14,647	0,307	1300	9,070	12,347	3600	6,278	23,666
40	14,424	0,604	1400	8,879	13,017	3800	6,122	24,359
60	14,210	0,893	1440	8,806	13,278	4000	5,973	25,017
80	14,005	1,173	1500	8,699	13,664	4500	5,629	26,523
100	13,809	1,446	1600	8,530	14,290	5000	5,319	27,847
200	12,949	2,712	1700	8,369	14,897	5500	5,036	29,006
300	12,259	3,851	1800	8,215	15,485	6000	4,778	30,016
400	11,705	4,903	1900	8,070	16,055	6500	4,540	30,890
500	11,263	5,897	2000	7,930	16,608	7000	4,320	31,630
600	10,890	6,842	2200	7,669	17,667	7500	4,110	32,260
700	10,556	7,738	2400	7,428	18,668	8000	3,910	32,780
800	10,254	8,590	2600	7,205	19,615	8500	3,730	33,190
900	9,979	9,404	2800	6,996	20,512	9000	3,560	33,510
1000	9,725	10,184	3000	6,800	21,363	9500	3,390	33,740
1100	9,491	10,932	3200	6,616	22,170	10000	3,230	33,870

The total power "P" and the total torque "M" transmitted by the belt, are calculated with the following formulas:

$$P \text{ [kW]} = P_{\text{spez}} \cdot Z_e \cdot Z_k \cdot b / 1000$$

$$M \text{ [Nm]} = M_{\text{spez}} \cdot Z_e \cdot Z_k \cdot b / 100$$

$$Z_e = \frac{Z_k}{180} \cdot \arccos \left[\frac{t \cdot (Z_g - Z_k)}{2 \cdot \pi \cdot A} \right]$$

P = power in kW

M = torque in Nm

P_{spez} = specific power

M_{spez} = specific torque

Z_e = number of teeth in mesh of the small pulley

Z_{emax} = 12

Z_k = number of teeth of the small pulley

b = belt width in cm

A = centre distance [mm]

t = pitch

Flexibility

Minimum pulley number of teeth and minimum idler diameter			
Drive without reverse bending		Timing pulley Z _{min}	25
		Flat idler running on belt teeth d _{min}	80 mm
Drive with reverse bending		Timing pulley Z _{min}	25
		Flat idler running on belt back d _{min}	150 mm

Minimum available length

Execution	Max width 50 mm
Standard	≥ 900 mm
PAZ	≥ 900 mm

ELA-flex SD™ EAGLE 14M

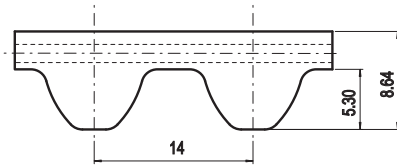

Belt characteristics

- Truly endless polyurethane timing belt with helical offset tooth, high tensile load steel cords and high torque capacity
- **Self tracking no need of pulley flanges**
- Metric pitch 14 mm
- **Extremely reduced noise generation**
- The special profile allows most compact drive

- Width tolerance: $\pm 1,2$ [mm]
- Thickness tolerance: $\pm 0,4$ [mm]

Technical Data

Belt width [mm]	35	52,5	70	105
Allowable tensile load [N]	13090	18700	26180	39270
Weight [kg/m]	0,4	0,6	0,8	1,2

Other widths are available on request.

Tooth shear strength

rpm [min ⁻¹]	M _{spez} [Ncm/cm]	P _{spez} [W/cm]	rpm [min ⁻¹]	M _{spez} [Ncm/cm]	P _{spez} [W/cm]	rpm [min ⁻¹]	M _{spez} [Ncm/cm]	P _{spez} [W/cm]
0	35,65	0,000	1200	20,07	25,222	3200	12,19	40,849
20	34,98	0,733	1300	19,46	26,495	3400	11,68	41,581
40	34,36	1,439	1400	18,89	27,698	3600	11,19	42,201
60	33,79	2,123	1440	18,68	28,160	3800	10,73	42,715
80	33,25	2,786	1500	18,36	28,834	4000	10,30	43,129
100	32,76	3,430	1600	17,85	29,909	-	-	-
200	30,76	6,441	1700	17,37	30,926	-	-	-
300	28,94	9,090	1800	16,92	31,888	-	-	-
400	27,43	11,491	1900	16,49	32,798	-	-	-
500	26,12	13,677	2000	16,07	33,659	-	-	-
600	24,97	15,689	2200	15,30	35,243	-	-	-
700	23,95	17,553	2400	14,59	36,656	-	-	-
800	23,03	19,290	2600	13,93	37,912	-	-	-
900	22,19	20,915	2800	13,31	39,023	-	-	-
1000	21,43	22,439	2880	13,07	39,429	-	-	-
1100	20,73	23,872	3000	12,73	39,999	-	-	-

The total power "P" and the total torque "M" transmitted by the belt, are calculated with the following formulas:

$$P \text{ [kW]} = P_{\text{spez}} \cdot Z_e \cdot Z_k \cdot b / 1000$$

$$M \text{ [Nm]} = M_{\text{spez}} \cdot Z_e \cdot Z_k \cdot b / 100$$

$$Z_e = \frac{Z_k}{180} \cdot \arccos \left[\frac{t \cdot (Z_g - Z_k)}{2 \cdot \pi \cdot A} \right]$$

P = power in kW

M = torque in Nm

P_{spez} = specific power

M_{spez} = specific torque

Z_e = number of teeth in mesh of the small pulley

Z_{emax} = 12

Z_k = number of teeth of the small pulley

b = belt width in cm

A = centre distance [mm]

t = pitch

Flexibility

Minimum pulley number of teeth and minimum idler diameter			
Drive without reverse bending		Timing pulley Z _{min}	32
		Flat idler running on belt teeth d _{min}	140 mm
Drive with reverse bending		Timing pulley Z _{min}	32
		Flat idler running on belt back d _{min}	200 mm

Minimum available length

Execution	Max width 105 mm
Standard	≥ 1800 mm
PAZ	≥ 1800 mm

ELA-flex SD™ AT K10 - K6

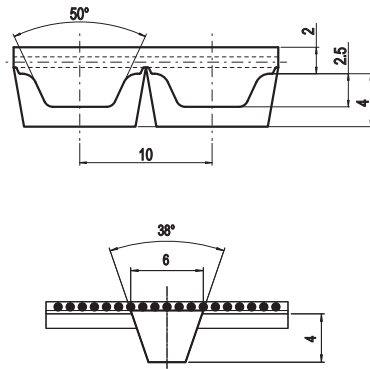

Belt characteristics

- Polyurethane self tracking timing belt with steel tension cords
- Profile AT10 with central guide
- Central guide height 4 mm
- Allows to use pulleys without flanges
- The central guide is notched in order to maximize belt flexibility
- Ideal for conveying applications where a side load is generated by loading/unloading or transferring a product
- **Dual toothing available from 1500 mm**

Technical Data

Belt width [mm]	32	50	75
Allowable tensile load type V [N]	5120	8090	12400
Weight [kg/m]	0,27	0,36	0,54

Other widths are available on request.

Tooth shear strength

rpm [min ⁻¹]	M _{spez} [Ncm/cm]	P _{spez} [W/cm]	rpm [min ⁻¹]	M _{spez} [Ncm/cm]	P _{spez} [W/cm]	rpm [min ⁻¹]	M _{spez} [Ncm/cm]	P _{spez} [W/cm]
0	12,048	0,000	1200	7,708	9,685	3400	5,317	18,931
20	11,871	0,249	1300	7,534	10,256	3600	5,180	19,529
40	11,706	0,490	1400	7,372	10,807	3800	5,048	20,088
60	11,550	0,726	1440	7,310	11,022	4000	4,924	20,625
80	11,403	0,955	1500	7,219	11,339	4500	4,636	21,846
100	11,265	1,180	1600	7,076	11,855	5000	4,377	22,915
200	10,684	2,238	1700	6,939	12,352	5500	4,140	23,841
300	10,215	3,209	1800	6,810	12,836	6000	3,923	24,648
400	9,793	4,102	1900	6,688	13,305	6500	3,724	25,348
500	9,424	4,934	2000	6,570	13,759	7000	3,538	25,933
600	9,097	5,716	2200	6,349	14,625	7500	3,365	26,423
700	8,808	6,456	2400	6,147	15,447	8000	3,202	26,825
800	8,547	7,159	2600	5,959	16,223	8500	3,048	27,127
900	8,309	7,831	2800	5,782	16,953	9000	2,903	27,358
1000	8,093	8,474	3000	5,618	17,649	9500	2,766	27,516
1100	7,893	9,091	3200	5,464	18,308	10000	2,636	27,598

The total power "P" and the total torque "M" transmitted by the belt, are calculated with the following formulas:

$$P \text{ [kW]} = P_{\text{spez}} \cdot Z_e \cdot Z_k \cdot b / 1000$$

$$M \text{ [Nm]} = M_{\text{spez}} \cdot Z_e \cdot Z_k \cdot b / 100$$

$$Z_e = \frac{Z_k \cdot \arccos\left(\frac{t \cdot (z_g - z_k)}{2 \cdot \pi \cdot A}\right)}{180}$$

P = power in kW

M = torque in Nm

P_{spez} = specific power

M_{spez} = specific torque

Z_e = number of teeth in mesh of the small pulley

Z_{emax} = 12

Z_k = number of teeth of the small pulley

b = belt width in cm

A = centre distance [mm]

t = pitch

Flexibility

Minimum pulley number of teeth and minimum idler diameter		
Drive without reverse bending	Timing pulley Z _{min}	15
	Flat idler running on belt teeth d _{min}	50 mm
Drive with reverse bending	Timing pulley Z _{min}	25
	Flat idler running on belt back d _{min}	120 mm

Minimum available length

Execution	Max width
	75 mm
Standard	≥ 1500 mm
PAZ	≥ 1800 mm

ELA-flex SD™

F2

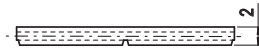
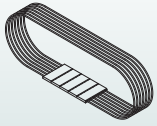

Belt characteristics

- Polyurethane flat belt with steel tension cords
- It is mainly used in drive applications where there is no need for synchronization
- Allows the use of small diameter pulleys

- Width tolerance: $\pm 0,5$ [mm]
- Thickness tolerance: $\pm 0,2$ [mm]

Technical Data

Belt width [mm]	25	32	50	75	100
Allowable tensile load [N]	4040	4850	8090	12400	16440
Weight [kg/m]	0,007	0,1	0,16	0,24	0,3

Other widths are available on request.

Flexibility

Minimum pulley diameter	Drive without reverse bending [mm]	Drive with reverse bending [mm]
	50	100

Minimum available length

Execution	Max width 100 mm
Standard	≥ 1500 mm
PAZ	≥ 1800 mm

ELA-flex SD™

F2,5

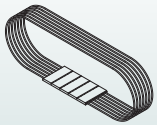

Belt characteristics

- Polyurethane flat belt with steel tension cords
- It is mainly used in drive applications where there is no need for synchronization
- Allows the use of small diameter pulleys

- Width tolerance: $\pm 0,8$ [mm]
- Thickness tolerance: $\pm 0,3$ [mm]

Technical Data

Belt width [mm]	20	25	50	75	100
Allowable tensile load [N]	2880	4320	9600	15360	21120
Weight [kg/m]	0,08	0,09	0,18	0,27	0,36

Other widths are available on request.

Flexibility

Minimum pulley diameter	Drive without reverse bending [mm]	Drive with reverse bending [mm]
	80	150

Minimum available length

Execution	Max width 100 mm
Standard	≥ 1500 mm
PAZ	≥ 1800 mm

ELA-flex SD™

F3

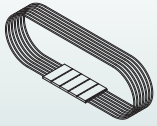

Belt characteristics

- Polyurethane flat belt with steel tension cords
- It is mainly used in drive applications where there is no need for synchronization
- Allows the use of small diameter pulleys

- Width tolerance: $\pm 1,0$ [mm]
- Thickness tolerance: $\pm 0,2$ [mm]

Technical Data

Belt width [mm]	25	30	60	100
Allowable tensile load [N]	9350	11220	22440	37400
Weight [kg/m]	0,20	0,25	0,50	1,00

Other widths are available on request.

Flexibility

Minimum pulley diameter	Drive without reverse bending [mm]	Drive with reverse bending [mm]
		120

Minimum available length

Execution	Max width 100 mm
	Standard
PAZ	≥ 1800 mm

ELATECH® iSync™ high performance timing belts

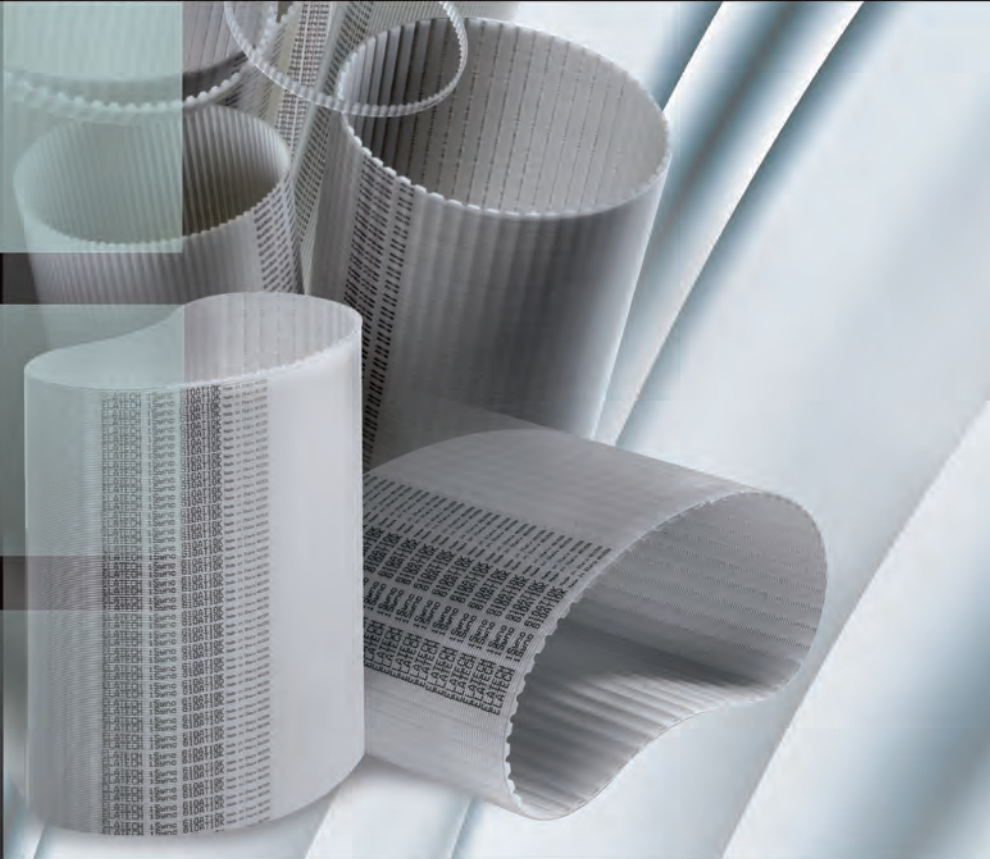
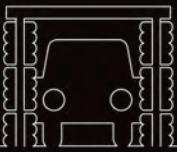

ELATECH® iSync™

In the spirit of continuous innovation, in order to answer to the increased need of industry in power transmission, **ELATECH®** has developed the **iSync™** range of belts. **iSync™** belts are made with special polyurethane compound and high resistance steel tension cords which are processed with a unique and highly sophisticated technology to get a superior polyurethane belt. **iSync™** belts offer optimal performances on all types of industrial applications.

iSync™ belts are able to transmit up to 30% more than conventional T, AT type of belts in the same space or same power with a more compact drive.

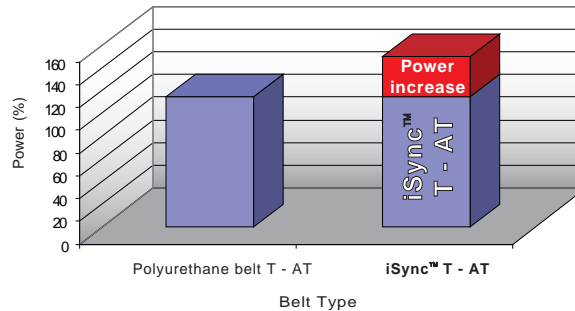

Features

- High power transmission capabilities
- Maintenance free
- Superior length stability
- Clean power transmission with no dust dispersion
- No contamination of object in contact
- Very high chemical resistance and particularly to oils, greases and gasoline
- Superior abrasion resistance
- High quality, thermo-set polyurethane designed specifically for timing belt applications
- Available with either steel or Kevlar® reinforcement
- Application temperature -10°C - +80 °C (standard). Up to +125 °C with special compound PU 53.

Typical application fields

ELATECH® iSync™ belts are suitable for power transmission drives where high precision is needed, cleanliness is critical and in difficult environment (presence of chemicals).

- Plotters
- Office automation
- Medical technology
- Packaging machines
- Swimming pool cleaning robots
- Banking machines
- Coin dispenser
- Vending machines
- Optical instruments
- Cameras
- Machine tools
- Robot arms
- Home appliances
- Vacuum systems
- Food processing machines
- Textile machines
- Gardening equipment and machines

Applications with special backing and cleats are specifically designed for special heavy duty conveying drives.

Available profile range

ELATECH® iSync™ belts are available in a standard range in the following profile range:

T2,5, T5, T10, AT5, AT10, L

As special the following profile can be manufactured on request **MXL, H, HTD5M, DD double sided executions.**

Tension cords

ELATECH® iSync™ timing belts are manufactured with high tensile strength steel cords as standard. All technical data shown in the catalogue are valid for standard cords. Belt with special cords have different mechanical and chemical properties. Special type of tension member such as stainless steel, HFE high flexibility or aramid fiber (Kevlar®) are available on request for special applications.

Aramid (Kevlar®) tension cords are used where non-magnetic drives are requested.

Stainless steel is used where high corrosion resistance is required.

Fiberglass and polyester are used where high flexibility and water resistance are required.

FDA - Approved Belts

ELATECH® has developed a special formulation for **iSync™** moulded belts for application in:

- packing
- conveying
- processing

of dairy, meat and food products which complies to the U.S. Food and Drugs Administration (FDA) law and regulations.

Please contact our Sales Department.

Standard belt sizes - single tothing

T2,5	
Number of teeth z	Length [mm]
48	120
58	145
64	160
71	177,5
72	180
80	200
84	210
92	230
98	245
106	265
111	277,5
114	285
116	290
122	305
127	317,5
132	330
137	342,5
152	380
168	420
192	480
200	500
216	540
240	600
260	650
312	780
366	915
380	950
590	1475

T5			
Number of teeth z	Length [mm]	Number of teeth z	Length [mm]
33	165	110	550
37	185	112	560
40	200	115	575
43	215	118	590
44	220	120	600
45	225	122	610
49	245	124	620
50	250	125	625
51	255	126	630
52	260	128	640
54	270	130	650
55	275	132	660
56	280	135	675
59	295	138	690
60	300	140	700
61	305	144	720
64	320	145	725
65	325	150	750
66	330	156	780
68	340	160	800
70	350	163	815
71	355	166	830
72	360	168	840
73	365	170	850
75	375	172	860
78	390	180	900
80	400	188	940
82	410	198	990
84	420	200	1000
85	425	215	1075
86	430	220	1100
88	440	223	1115
89	445	228	1140
90	450	240	1200
91	455	243	1215
92	460	253	1265
95	475	263	1315
96	480	270	1350
100	500	271	1355
102	510	276	1380
105	525	288	1440
109	545		

T10			
Number of teeth z	Length [mm]	Number of teeth z	Length [mm]
26	260	97	970
32	320	98	980
35	350	100	1000
37	370	101	1010
40	400	105	1050
41	410	108	1080
44	440	110	1100
45	450	111	1110
48	480	114	1140
50	500	115	1150
53	530	120	1200
55	550	121	1210
56	560	124	1240
60	600	125	1250
61	610	130	1300
63	630	132	1320
65	650	135	1350
66	660	139	1390
69	690	140	1400
70	700	142	1420
72	720	144	1440
75	750	145	1450
78	780	146	1460
80	800	150	1500
81	810	156	1560
84	840	160	1600
85	850	161	1610
88	880	170	1700
89	890	175	1750
90	900	178	1780
91	910	180	1800
92	920	188	1880
95	950	196	1960
96	960	225	2250

VACUUM - T10	
Number of teeth z	Length [mm]
63	630
92	920

Order example
 ELATECH® iSync™ Timing Belt U 420 T5 / 16

Standard belt sizes Dual toothing

AT5	
Number of teeth z	Length [mm]
45	225
51	255
56	280
60	300
68	340
75	375
78	390
84	420
90	450
91	455
100	500
109	545
120	600
122	610
132	660
144	710
144	720
150	750
156	780
165	825
172	860
195	975
210	1050
225	1125
300	1500

AT10	
Number of teeth z	Length [mm]
50	500
53	530
56	560
58	580
60	600
61	610
66	660
70	700
73	730
78	780
80	800
84	840
88	880
89	890
92	920
96	960
98	980
100	1000
101	1010
105	1050
108	1080
110	1100
115	1150
120	1200
121	1210
125	1250
128	1280
130	1300
132	1320
135	1350
136	1360
140	1400
142	1420
148	1480
150	1500
160	1600
170	1700
172	1720
180	1800
186	1860
194	1940

DT5	
Number of teeth z	Length [mm]
82	410
92	460
118	590
124	620
150	750
163	815
172	860
188	940
220	1100

DT10	
Number of teeth z	Length [mm]
26	260
53	530
63	630
66	660
72	720
84	840
92	920
98	980
121	1210
124	1240
125	1250
132	1320
135	1350
142	1420
161	1610
188	1880

L	
Number of teeth z	Length [inch]
60	22,5
64	24
68	25,5
72	27
76	28,5
80	30
136	51
144	54

Order example		
ELATECH® iSync™ Timing Belt	U	450 AT5 / 16
ELATECH® iSync™ Timing Belt	U	225 L / 100

Order example		
ELATECH® iSync™ Timing Belt	U	620 DT5 / 16

Special belts

Special belts with cleats, backing and with special moulded shape are designed and manufactured to maximize application performance.



ELATECH® iSync™ high performance endless timing belt technical data

iSync™ T 2,5

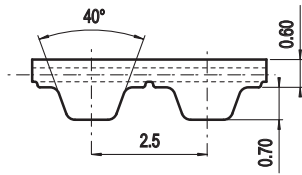
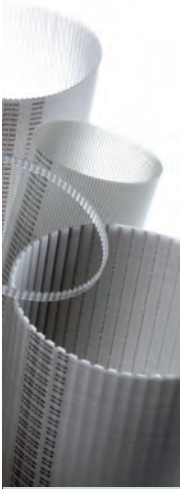

Belt characteristics

- Truly endless polyurethane timing belt with steel tension cords according to DIN 7721 T1
- Metric pitch 2,5 mm
- Ideal for drives where high belt flexibility is required
- Allows the use of small diameter pulleys
- Transmissible power up to 5 kW
- Rpm up to 10.000 [1/min]

- Width tolerance: ±0,3 [mm]
- Thickness tolerance: ±0,2 [mm]

Technical Data

Belt width [mm]	4	6	8	10	12	16	25	32
Allowable tensile load [N]	45	69	103	130	152	220	343	451
Weight [g/m]	6	9	12	15	18	24	37	48

Other widths are available on request.

Tooth shear strength

rpm [min ⁻¹]	M _{spez} [Ncm/cm]	P _{spez} [W/cm]	rpm [min ⁻¹]	M _{spez} [Ncm/cm]	P _{spez} [W/cm]	rpm [min ⁻¹]	M _{spez} [Ncm/cm]	P _{spez} [W/cm]
0	0,47	0,000	1200	0,29	0,361	3400	0,23	0,810
20	0,45	0,010	1300	0,28	0,385	3600	0,22	0,845
40	0,44	0,018	1400	0,28	0,408	3800	0,22	0,880
60	0,43	0,027	1440	0,28	0,417	4000	0,22	0,914
80	0,42	0,035	1500	0,27	0,431	4500	0,21	0,996
100	0,41	0,043	1600	0,27	0,454	5000	0,21	1,074
200	0,38	0,080	1700	0,27	0,476	5500	0,20	1,150
300	0,36	0,114	1800	0,26	0,498	6000	0,19	1,223
400	0,35	0,145	1900	0,26	0,519	6500	0,19	1,293
500	0,34	0,175	2000	0,26	0,541	7000	0,19	1,360
600	0,33	0,204	2200	0,25	0,582	7500	0,18	1,426
700	0,32	0,232	2400	0,25	0,622	8000	0,18	1,489
800	0,31	0,259	2600	0,24	0,662	8500	0,17	1,551
900	0,30	0,286	2800	0,24	0,700	9000	0,17	1,611
1000	0,30	0,311	3000	0,24	0,715	9500	0,17	1,668
1100	0,29	0,336	3200	0,23	0,738	10000	0,16	1,725

The total power "P" and the total torque "M" transmitted by the belt, are calculated with the following formulas:

$$P \text{ [kW]} = P_{spez} \cdot Z_e \cdot Z_k \cdot b / 1000$$

$$M \text{ [Nm]} = M_{spez} \cdot Z_e \cdot Z_k \cdot b / 100$$

$$Z_e = \frac{Z_k}{180} \cdot \arccos \left[\frac{t \cdot (z_g - z_k)}{2 \cdot \pi \cdot A} \right]$$

P = power in kW

M = torque in Nm

P_{spez} = specific power

M_{spez} = specific torque

Z_e = number of teeth in mesh of the small pulley

Z_{emax} = 12

Z_k = number of teeth of the small pulley

b = belt width in cm

A = centre distance [mm]

t = pitch

Flexibility

Minimum pulley number of teeth and minimum idler diameter			
Drive without reverse bending		Timing pulley Z _{min}	10
		Flat idler running on belt teeth d _{min}	15 mm
Drive with reverse bending		Timing pulley Z _{min}	18
		Flat idler running on belt back d _{min}	15 mm

iSync™ T 5 / T 5 Dual

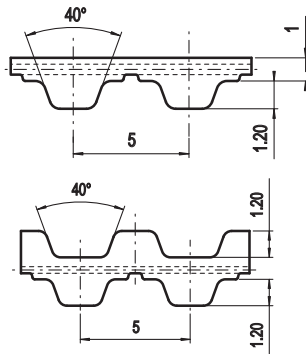
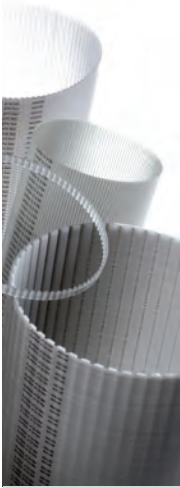

Belt characteristic

- Truly endless polyurethane timing belt with steel tension cords according to DIN 7721 T1
- Metric pitch 5 mm
- Ideal for drives where high belt flexibility is required
- Allows the use of small diameter pulleys
- Rpm up to 10.000 [1/min]

- Width tolerance: $\pm 0,5$ [mm]
- Thickness tolerance: $\pm 0,15$ [mm]

Technical Data

Belt width [mm]	10	12	16	25	32	50	75	100
Allowable tensile load [N]	430	520	690	1090	1380	2170	3290	4160
Weight [g/m]	24	28	38	60	77	120	180	240
Weight DT5 [g/m]	27	32	43	68	97	138	210	270

Other widths are available on request.

Tooth shear strength

rpm [min ⁻¹]	M _{spez} [Ncm/cm]	P _{spez} [W/cm]	rpm [min ⁻¹]	M _{spez} [Ncm/cm]	P _{spez} [W/cm]	rpm [min ⁻¹]	M _{spez} [Ncm/cm]	P _{spez} [W/cm]
0	2,523	0,000	1200	1,607	2,019	3400	1,248	4,444
20	2,458	0,051	1300	1,580	2,151	3600	1,229	4,632
40	2,403	0,101	1400	1,555	2,279	3800	1,209	4,812
60	2,354	0,148	1440	1,545	2,330	4000	1,191	4,988
80	2,312	0,194	1500	1,532	2,406	4500	1,149	5,414
100	2,276	0,238	1600	1,510	2,529	5000	1,111	5,818
200	2,135	0,447	1700	1,489	2,651	5500	1,078	6,206
300	2,032	0,638	1800	1,470	2,770	6000	1,046	6,571
400	1,951	0,817	1900	1,451	2,888	6500	1,017	6,924
500	1,884	0,987	2000	1,433	3,001	7000	0,991	7,262
600	1,829	1,149	2200	1,400	3,226	7500	0,966	7,588
700	1,781	1,306	2400	1,371	3,445	8000	0,943	7,897
800	1,738	1,456	2600	1,342	3,654	8500	0,920	8,191
900	1,701	1,603	2800	1,317	3,860	9000	0,900	8,480
1000	1,667	1,745	3000	1,306	3,940	9500	0,880	8,758
1100	1,635	1,884	3200	1,292	4,059	10000	0,862	9,027

The total power "P" and the total torque "M" transmitted by the belt, are calculated with the following formulas:

$$P \text{ [kW]} = P_{\text{spez}} \cdot Z_e \cdot Z_k \cdot b / 1000$$

$$M \text{ [Nm]} = M_{\text{spez}} \cdot Z_e \cdot Z_k \cdot b / 100$$

$$Z_e = \frac{Z_k}{180} \cdot \arccos \left[\frac{t \cdot (Z_g - Z_k)}{2 \cdot \pi \cdot A} \right]$$

P = power in kW

M = torque in Nm

P_{spez} = specific power

M_{spez} = specific torque

Z_e = number of teeth in mesh of the small pulley

Z_{emax} = 12

Z_k = number of teeth of the small pulley

b = belt width in cm

A = centre distance [mm]

t = pitch

Flexibility

Minimum pulley number of teeth and minimum idler diameter			
Drive without reverse bending		Timing pulley Z _{min}	10
		Flat idler running on belt teeth d _{min}	30 mm
Drive with reverse bending		Timing pulley Z _{min}	15
		Flat idler running on belt back d _{min}	30 mm

iSync™ T 10 / T 10 Dual

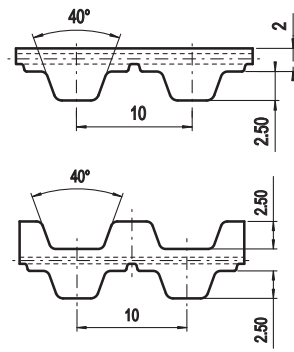

Belt characteristics

- Truly endless polyurethane timing belt with steel tension cords according to DIN 7721 T1
- Metric pitch 10 mm
- Ideal for drives where high belt flexibility is required
- Allows the use of small diameter pulleys
- Rpm up to 10.000 [1/min]

- Width tolerance: ±0,5 [mm]
- Thickness tolerance: ±0,2 [mm]

Technical Data

Belt width [mm]	10	16	25	32	50	75	100	150
Allowable tensile load [N]	890	1520	2280	3040	4680	7080	9490	14170
Weight [g/m]	50	77	120	155	240	365	480	725
Weight DT10 [g/m]	62	92	145	190	290	430	570	900

Other widths are available on request.

Tooth shear strength

rpm [min ⁻¹]	M _{spez} [Ncm/cm]	P _{spez} [W/cm]	rpm [min ⁻¹]	M _{spez} [Ncm/cm]	P _{spez} [W/cm]	rpm [min ⁻¹]	M _{spez} [Ncm/cm]	P _{spez} [W/cm]
0	8,244	0,000	1200	4,808	6,042	3400	3,460	12,318
20	8,009	0,168	1300	4,708	6,409	3600	3,385	12,761
40	7,805	0,327	1400	4,614	6,764	3800	3,312	13,179
60	7,627	0,479	1440	4,577	6,902	4000	3,245	13,592
80	7,472	0,626	1500	4,526	7,109	4500	3,088	14,549
100	7,339	0,768	1600	4,444	7,445	5000	2,946	15,424
200	6,804	1,425	1700	4,366	7,771	5500	2,817	16,224
300	6,411	2,014	1800	4,292	8,090	6000	2,701	16,969
400	6,105	2,557	1900	4,222	8,401	6500	2,593	17,646
500	5,857	3,066	2000	4,157	8,706	7000	2,492	18,269
600	5,648	3,549	2200	4,033	9,291	7500	2,398	18,836
700	5,467	4,007	2400	3,920	9,851	8000	2,311	19,359
800	5,306	4,445	2600	3,815	10,386	8500	2,228	19,832
900	5,163	4,866	2800	3,718	10,901	9000	2,150	20,264
1000	5,034	5,271	3000	3,680	11,097	9500	2,077	20,661
1100	4,916	5,663	3200	3,626	11,389	10000	2,007	21,015

The total power "P" and the total torque "M" transmitted by the belt, are calculated with the following formulas:

$$P \text{ [kW]} = P_{\text{spez}} \cdot Z_e \cdot Z_k \cdot b / 1000$$

$$M \text{ [Nm]} = M_{\text{spez}} \cdot Z_e \cdot Z_k \cdot b / 100$$

$$Z_e = \frac{Z_k}{180} \cdot \arccos \left[\frac{t \cdot (z_g - z_k)}{2 \cdot \pi \cdot A} \right]$$

P = power in kW

M = torque in Nm

P_{spez} = specific power

M_{spez} = specific torque

Z_e = number of teeth in mesh of the small pulley

Z_{emax} = 12

Z_k = number of teeth of the small pulley

b = belt width in cm

A = centre distance [mm]

t = pitch

Flexibility

Minimum pulley number of teeth and minimum idler diameter			
Drive without reverse bending		Timing pulley Z _{min}	12
		Flat idler running on belt teeth d _{min}	60 mm
Drive with reverse bending		Timing pulley Z _{min}	20
		Flat idler running on belt back d _{min}	60 mm

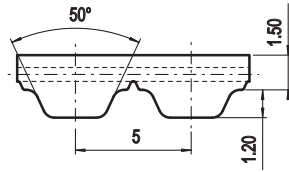
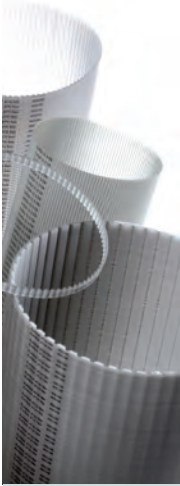

Belt characteristics

- Truly endless polyurethane timing belt with steel tension cords.
- Metric pitch 5 mm
- Tooth profile and dimension are optimised to guarantee uniform load distribution and minimum deformation under load
- High resistance and low stretch steel cords to guarantee high stability and low elongation
- Reduced polygonal effect with reduced drive vibration and noise
- Rpm up to 10.000 [1/min]

- Width tolerance: ±0,5 [mm]
- Thickness tolerance: ±0,15 [mm]

Technical Data

Belt width [mm]	6	10	16	25	32	50	75	100
Allowable tensile load [N]	430	790	1350	2200	2950	4700	7100	9500
Weight [g/m]	21	34	54	86	110	175	260	350

Other widths are available on request.

Tooth shear strength

rpm [min ⁻¹]	M _{spez} [Ncm/cm]	P _{spez} [W/cm]	rpm [min ⁻¹]	M _{spez} [Ncm/cm]	P _{spez} [W/cm]	rpm [min ⁻¹]	M _{spez} [Ncm/cm]	P _{spez} [W/cm]
0	3,813	0,000	1200	2,668	3,352	3400	1,993	7,096
20	3,758	0,079	1300	2,620	3,566	3600	1,954	7,368
40	3,708	0,155	1400	2,574	3,773	3800	1,917	7,627
60	3,663	0,230	1440	2,557	3,855	4000	1,881	7,879
80	3,623	0,304	1500	2,531	3,975	4500	1,799	8,479
100	3,586	0,376	1600	2,491	4,173	5000	1,725	9,032
200	3,448	0,722	1700	2,452	4,365	5500	1,658	9,549
300	3,343	1,050	1800	2,416	4,554	6000	1,596	10,029
400	3,235	1,355	1900	2,381	4,737	6500	1,539	10,473
500	3,137	1,642	2000	2,348	4,918	7000	1,485	10,887
600	3,050	1,916	2200	2,285	5,265	7500	1,436	11,278
700	2,972	2,178	2400	2,229	5,601	8000	1,389	11,635
800	2,900	2,430	2600	2,175	5,923	8500	1,346	11,980
900	2,834	2,671	2800	2,125	6,231	9000	1,304	12,289
1000	2,775	2,905	3000	2,106	6,352	9500	1,264	12,576
1100	2,719	3,132	3200	2,079	6,531	10000	1,228	12,854

The total power "P" and the total torque "M" transmitted by the belt, are calculated with the following formulas:

$$P \text{ [kW]} = P_{\text{spez}} \cdot Z_e \cdot Z_k \cdot b / 1000$$

$$M \text{ [Nm]} = M_{\text{spez}} \cdot Z_e \cdot Z_k \cdot b / 100$$

$$Z_e = \frac{Z_k}{180} \cdot \arccos \left[\frac{t \cdot (Z_g - Z_k)}{2 \cdot \pi \cdot A} \right]$$

P = power in kW

M = torque in Nm

P_{spez} = specific power

M_{spez} = specific torque

Z_e = number of teeth in mesh of the small pulley

Z_{emax} = 12

Z_k = number of teeth of the small pulley

b = belt width in cm

A = centre distance [mm]

t = pitch

Flexibility

Minimum pulley number of teeth and minimum idler diameter			
Drive without reverse bending		Timing pulley Z _{min}	15
		Flat idler running on belt teeth d _{min}	25 mm
Drive with reverse bending		Timing pulley Z _{min}	20
		Flat idler running on belt back d _{min}	60 mm

iSync™ AT 10

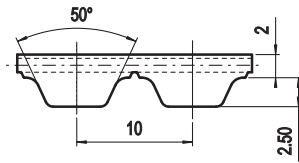
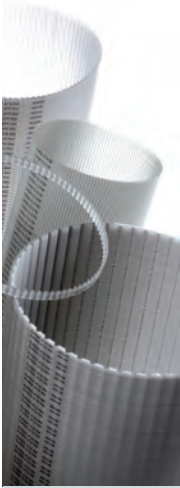

Belt characteristics

- Truly endless polyurethane timing belt with steel tension cords.
- Metric pitch 10 mm
- Tooth profile and dimension are optimised to guarantee uniform load distribution and minimum deformation under load
- High resistance and low stretch steel cords to guarantee high stability and low elongation
- Reduced polygonal effect with reduced drive vibration and noise
- Rpm up to 10.000 [1/min]

- Width tolerance: ±0,5 [mm]
- Thickness tolerance: ±0,2 [mm]

Technical Data

Belt width [mm]	16	25	32	50	75	100	150
Allowable tensile load [N]	3150	5450	7100	1100	17200	23000	34600
Weight [g/m]	101	158	200	316	475	630	950

Other widths are available on request.

Tooth shear strength

rpm [min ⁻¹]	M _{spez} [Ncm/cm]	P _{spez} [W/cm]	rpm [min ⁻¹]	M _{spez} [Ncm/cm]	P _{spez} [W/cm]	rpm [min ⁻¹]	M _{spez} [Ncm/cm]	P _{spez} [W/cm]
0	15,903	0,000	1200	10,174	12,785	3400	7,019	24,989
20	15,670	0,328	1300	9,945	13,538	3600	6,838	25,778
40	15,452	0,647	1400	9,731	14,266	3800	6,664	26,516
60	15,246	0,958	1440	9,649	14,550	4000	6,500	27,225
80	15,053	1,261	1500	9,529	14,968	4500	6,120	28,837
100	14,870	1,557	1600	9,340	15,649	5000	5,777	30,248
200	14,103	2,954	1700	9,160	16,305	5500	5,464	31,470
300	13,483	4,236	1800	8,990	16,944	6000	5,179	32,536
400	12,927	5,414	1900	8,828	17,563	6500	4,916	33,460
500	12,439	6,513	2000	8,672	18,162	7000	4,670	34,232
600	12,008	7,545	2200	8,380	19,305	7500	4,441	34,878
700	11,626	8,522	2400	8,113	20,390	8000	4,227	35,409
800	11,282	9,451	2600	7,866	21,414	8500	4,023	35,808
900	10,969	10,337	2800	7,632	22,378	9000	3,832	36,113
1000	10,683	11,186	3000	7,544	22,751	9500	3,651	36,322
1100	10,418	12,000	3200	7,416	23,296	10000	3,479	36,429

The total power "P" and the total torque "M" transmitted by the belt, are calculated with the following formulas:

$$P \text{ [kW]} = P_{\text{spez}} \cdot Z_e \cdot Z_k \cdot b / 1000$$

$$M \text{ [Nm]} = M_{\text{spez}} \cdot Z_e \cdot Z_k \cdot b / 100$$

$$Z_e = \frac{Z_k}{180} \cdot \arccos \left[\frac{t \cdot (Z_g - Z_k)}{2 \cdot \pi \cdot A} \right]$$

P = power in kW

M = torque in Nm

P_{spez} = specific power

M_{spez} = specific torque

Z_e = number of teeth in mesh of the small pulley

Z_{emax} = 12

Z_k = number of teeth of the small pulley

b = belt width in cm

A = centre distance [mm]

t = pitch

Flexibility

Minimum pulley number of teeth and minimum idler diameter			
Drive without reverse bending		Timing pulley Z _{min}	15
		Flat idler running on belt teeth d _{min}	50 mm
Drive with reverse bending		Timing pulley Z _{min}	25
		Flat idler running on belt back d _{min}	120 mm

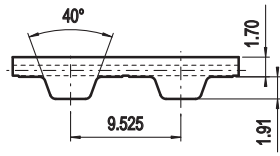
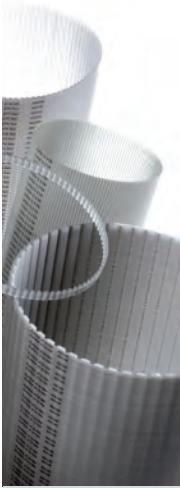

Belt characteristics

- Truly endless polyurethane timing belt with steel tension cords and trapezoidal tooth profile according to DIN/ISO 5296.
- Imperial pitch 3/8" = 9,525 mm
- Mainly used in applications where inch pitch is an advantage
- Transmissible power up to 20 kW
- Rpm up to 10.000 [1/min]

- Width tolerance: ±0,5 [mm]
- Thickness tolerance: ±0,2 [mm]

Technical Data

Belt width [inch]	0,50	0,75	1,00	1,50	2,00	3,00	4,00
Allowable tensile load [N]	1140	1770	2400	3540	4810	7210	9610
Weight [g/m]	50	80	100	150	200	300	400

Other widths are available on request.

Tooth shear strength

rpm [min ⁻¹]	M _{spez} [Ncm/cm]	P _{spez} [W/cm]	rpm [min ⁻¹]	M _{spez} [Ncm/cm]	P _{spez} [W/cm]	rpm [min ⁻¹]	M _{spez} [Ncm/cm]	P _{spez} [W/cm]
0	5,852	0,000	1200	3,393	4,263	3400	2,441	8,689
20	5,673	0,119	1300	3,321	4,521	3600	2,388	9,000
40	5,518	0,231	1400	3,256	4,774	3800	2,336	9,295
60	5,383	0,338	1440	3,230	4,871	4000	2,288	9,581
80	5,266	0,441	1500	3,194	5,017	4500	2,177	10,258
100	5,165	0,541	1600	3,137	5,255	5000	2,077	10,874
200	4,789	1,003	1700	3,082	5,486	5500	1,986	11,437
300	4,516	1,419	1800	3,029	5,709	6000	1,903	11,953
400	4,304	1,803	1900	2,980	5,930	6500	1,827	12,433
500	4,131	2,163	2000	2,933	6,143	7000	1,755	12,867
600	3,984	2,503	2200	2,845	6,555	7500	1,689	13,263
700	3,857	2,827	2400	2,765	6,949	8000	1,627	13,626
800	3,744	3,137	2600	2,692	7,330	8500	1,569	13,965
900	3,644	3,434	2800	2,623	7,689	9000	1,513	14,258
1000	3,553	3,721	3000	2,559	8,039	9500	1,461	14,537
1100	3,470	3,997	3200	2,498	8,371	10000	1,411	14,779

The total power "P" and the total torque "M" transmitted by the belt, are calculated with the following formulas:

$$P \text{ [kW]} = P_{\text{spez}} \cdot Z_e \cdot Z_k \cdot b / 1000$$

$$M \text{ [Nm]} = M_{\text{spez}} \cdot Z_e \cdot Z_k \cdot b / 100$$

$$Z_e = \frac{Z_k}{180} \cdot \arccos \left[\frac{t \cdot (Z_g - Z_k)}{2 \cdot \pi \cdot A} \right]$$

- P = power in kW
- M = torque in Nm
- P_{spez} = specific power
- M_{spez} = specific torque
- Z_e = number of teeth in mesh of the small pulley
- Z_emax = 12
- Z_k = number of teeth of the small pulley
- b = belt width in cm
- A = centre distance [mm]
- t = pitch

Flexibility

Minimum pulley number of teeth and minimum idler diameter			
Drive without reverse bending		Timing pulley Z _{min}	15
		Flat idler running on belt teeth d _{min}	60 mm
Drive with reverse bending		Timing pulley Z _{min}	20
		Flat idler running on belt back d _{min}	60 mm

ELATECH® Conveying Applications

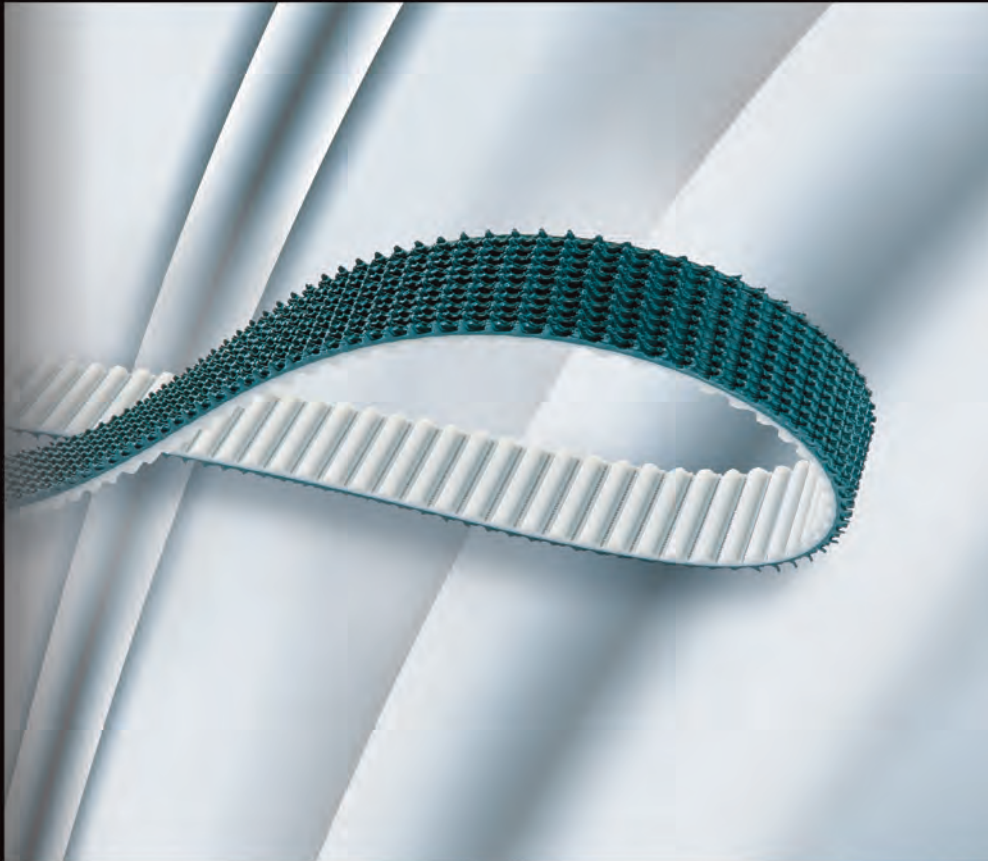

Polyurethane belts for conveying applications:

Backings

The unique chemical and mechanical features of ELATECH® belts together with the possibility of a wide range of backings in different materials make ELATECH® belts ideal for all conveying applications where synchronization is required. The engineer designer has unlimited possibilities to make a unique design.

Minimum pulley diameter

The minimum pulley diameter can be calculated by means of the "pulley multiplier" shown for each type of backing.

Minimum pulley diameter = backing thickness x pulley multiplier C_D

As a general rule, we may say that the smaller the pulley, the thinner the backing has to be.

The diameters obtained are valid for application with speed up to 1 m/s and a temperature of 20° C.

If smaller pulley diameters are needed, please contact Elatech's technical dept.

Drive with reverse bending

ELATECH® polyurethane timing belts are suitable for drives with reverse bending. Tension should be adjusted, depending on backing hardness.

Temperature range

The choice of the correct backing may allow the conveying of hot items. However, the toothed structure of the belt must not be exposed to temperatures over 80° C.

The minimum contact temperature should be -10° C for all backing materials, however, special material compounds may be available for lower temperatures. In such cases, please check with Elatech's technical department.

Coefficient of friction

The values shown in the table refer to the approximate static coefficient of friction against steel.

In order to reduce the pulley's diameter, it is possible to splice the backing allowing a better flexibility. Pulley diameter, should never be smaller than the minimum diameter recommended for the standard belt.

Please ask ELATECH's technical dept. for further details on coefficient of friction with other materials.

Colours

Standard colours shown in the table may change without notice. Special/personalized colours are available on request.

Chemical resistance

The values given in the table for the resistance to oils and fat of each backing material are purely indicative and may vary depending on the concentration and the temperature of chemical agents. When in doubt, please check with Elatech's technical department.

General remarks

ELATECH's wide range of different backings can be grouped into four main categories: cellular, PVC & PU, rubber, and special. Each different category provides special features and top quality performance and endurance making the various backings especially suitable for specific applications. These features include different degrees of hardness, cellular, fabric, felt or solid material compounds, different levels of grip, FDA-compliant materials, antistatic materials, different resistance to oils and fats, and different resistance to abrasion, tear and wear.

Such variety, combined with top quality mechanical and technical properties and state of the art manufacturing systems and techniques including the application of different flights and cleats, the combination of different backing materials, the slitting and grinding of the final product to match exact dimensions and shapes without any burrs or any other imperfections left on the surface, as well as water jet cutting for extremely precise perforations, make ELATECH®'s coated belts the best and the most reliable solution for specific applications in the most diversified fields of industry.

Covering Materials

FABRIC

Polyamide fabric backings

The special polyamide fabric backings allow a reduction of the friction coefficient and when applied on teeth, decrease noise in high speed drives. They are very useful in applications with sliding surfaces or product accumulation.

Polyamide fabrics with antistatic properties are available.

PAZ: Polyamide backing on tooth side.
Reduces coefficient of friction and allows a smoother tooth engagement.

PAR: Polyamide backing on back side.
Reduces coefficient of friction.

PAZ-PAR: Polyamide backing on both tooth and back side

Coefficient of friction







- Polyurethane on steel $\mu = 0,7$
- Polyamide on steel $\mu = 0,35$

Elatech Code	Description		
TZ11	PAZ Standard		Nylon fabric on teeth
TZ21	PAR Standard		Nylon fabric on back
TZ15	PAZ Antistatic		Antistatic nylon fabric on teeth
TZ25	PAR Antistatic		Antistatic nylon fabric on back

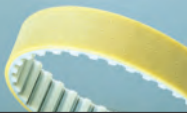

Polyurethane / Rubber foam backings are easily compressible according to the cellular structure of the material. Due to this main characteristic, common applications are: labelling equipment, light and/or fragile materials conveying, glass and paper industry, vacuum conveyors.

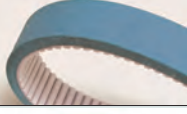
Pulley diameter: C_D • Backing Thickness

Elatech Code	Description	Material	Color	Hardness [°Sh A]	Standard thickness [mm]	Max contact temperature	Oil and fat resistance	coef. of friction on steel	FDA food grade	Pulley multiplier C _D
CFX	CELLOFLEX 	Microcellular elastomeric polyurethane	brown / yellow	-	3 - 10	+80°C	medium	0,3	No	16
POR	POROL 	cellular rubber	black	ca 15	3, 5, 8,10,15	+70°C	medium	1,0	No	6
PY50	PU YELLOW 50 	polyurethane	yellow	50	2, 3, 4, 5 6, 8,10	+70°C	high	0,4	No	20
PY70	PU YELLOW 70 	polyurethane	yellow	70	2, 3, 4, 5, 6, 8,10	+80°C	high	0,3	No	18
SYL-B	SYLOMER BLU 	Elastomeric PUR	blu	-	6, 12, 25	+70°C	medium	0,5	No	12
SYL-V	SYLOMER GREEN 	Elastomeric PUR	green	-	6, 12, 25	+70°C	medium	0,5	No	14
SYL-M	SYLOMER BROWN 	Elastomeric PUR	brown	-	6, 12, 25	+70°C	medium	0,5	No	15









Covering Materials PVC and PU

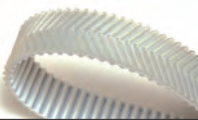

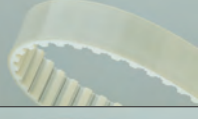
PVC has a high coefficient of friction and a good resistance to acids. Due to its versatility, it is used in many applications in the paper, glass, ceramic industry, labelling and packing equipment. FDA quality allows the application in food industry processes.

Among all synthetic materials and rubber compounds, polyurethane is the material which offers the best resistance to abrasion. Polyurethane films of different thickness and different shore hardness, applied on ELATECH® belts, are an ideal solution in many applications in the wood processing, ceramic and glass industry. On request it is possible to supply polyurethane backings FDA approved.

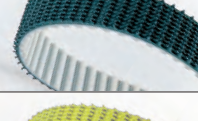
Pulley diameter: C_D • Backing Thickness







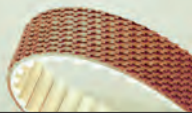

Elatech Code	Description	Material	Color	Hardness [°Sh A]	Standard thickness [mm]	Max contact temperature	Oil and fat resistance	coef. of friction on steel	FDA food grade	Pulley multiplier C_D
FBPU	FISHBONE PU 	PU	transparent	70 / 85	4	+70°C	medium	0,7	No	18
FBPVC	FISHBONE PVC 	PVC	white	65	4	+80°C	high	0,7	Yes	18
PUR70	PUR70 	PU	transparent	70	2 - 5	+70°C	high	0,7	No	25
PUR85	PUR85 	PU	transparent	85	2 - 5	+70°C	high	0,6	No	30
PVCW	PVC BIANCO 	PVC	white	ca 60	2,3	+90°C	medium	1,0	Yes	35
PVCG	PVC GREEN 	PVC	green	ca 40	1	+90°C	high	0,9	No	40
SG50R	SUPERGRIP 50 R 	Thermoplastic compound	red	55	4,5 - 12	+80°C	medium	0,9	No	12
SG60	SUPERGRIP 60 GL 	PVC	green	ca 40	4,5	+90°C	medium	0,9	No	12
SG70	SUPERGRIP 70 Y 	PU	yellow	70	4,5	+80°C	high	0,8	No	12
MG	MINIGRIP PVC 	PVC	green	ca 65	1,5	+100°C	medium	0,7	No	40

Covering Materials

RUBBER

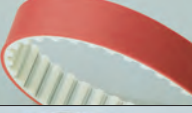
Many different rubber backings in both synthetic and natural rubber are available. Due to rubber's high friction coefficient and high temperature resistance, ELATECH® polyurethane belt with rubber backing is used in many different conveying application: paper industry, ceramic industry, wood processing industry, glass industry, labelling and packaging machines.

Pulley diameter: C_D • Backing Thickness







Elatech Code	Description	Material	Color	Hardness [°Sh A]	Standard thickness [mm]	Max contact temperature	Oil and fat resistance	coef. of friction on steel	FDA food grade	Pulley multiplier C _D
SG50T	SUPERGRIP 50 RT 	natural rubber	red	50	4,5	+80°C	low	1,0	No	15
LTX	LINATEX 	natural rubber	red	ca 40	2,4 - 3,2 - 4,8 6,4 - 8,0 - 9,6	+70°C	low	1,1	No	15
LTR	LINATRILE 	nitrile rubber	orange	ca 55	3 - 6	+110°C	medium	1,0	No	20
NBR	NITRILE 	nitrile rubber	black	65	-	+110°C	high	0,7	No	18
TNX	TENAX / ISOGUM 	rubber	red	40	2 - 15	+60°C	low	0,75	No	15
VTN	VITON 	FKM Fluoroelastomer	black	ca 75	2/4	+275°C	high	0,7	No	30
RP400	YELLOW RUBBER 	natural rubber	yellow	ca 35	3 - 4 - 5 - 6 - 8 10 - 12 - 15 20 - 25 - 30	+65°C	low	1,2	No	13
CRX	CORREX 	para rubber	brown	ca 40	6 - 10	+60°C	low	0,6	No	15

Covering Materials SPECIAL



Special backings are available in quite a different range of materials to cover even the most demanding design requirements.

Pulley diameter: C_D • Backing Thickness

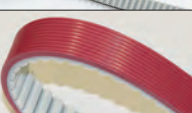
Elatech Code	Description	Material	Color	Hardness [°Sh A]	Standard thickness [mm]	Max contact temperature	Oil and fat resistance	coef. of friction on steel	FDA food grade	Pulley multiplier C_D
APL	APL 	Thermoplastic compound	red-purple	55	3,5	+60°C	high	0,7	No	25
SLC	SILICONE 	Silicone rubber	transparent	30	3 - 10	+200°C	high	1,0	No	20
SLCF	SILICONE FDA 	Silicone rubber	blu	30	3 - 10	+220°C	high	1,1	Yes	20
TG50	TECNOGUM 50 	Thermoplastic rubber compound	red	ca 50	1 - 6	+80°C	high	0,7	No	25
TG70	TECNOGUM 70 	Thermoplastic rubber compound	red	ca 70	1 - 6	+80°C	high	0,6	No	30
CHRL	CHROME LEATHER 	Chrome leather	grey / blue	-	3	+80°C	high	0,8	No	30
TZ26	TZ PAR 	Teflon	red	-	0,3	+80°C	high	0,18	No	-
APLM	MULTIRIB 	Thermoplastic compound	red	60	3,5	+80°C	medium	-	No	-

ELATECH® EMF - Mechanical Fastening System

(patent pending)

ELATECH® EMF - Mechanical Fastening System allows in many conveying applications cost savings associated with being able to design equipment around the installation principle of EMF.

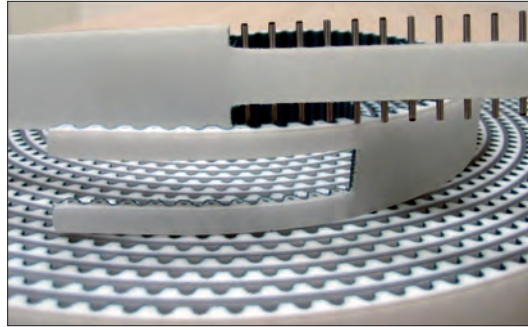

Features

- EMF has no exposed metal parts, therefore no metal contact is made with pulleys, so it runs very quietly. Since there are no exposed metal parts, EMF will not damage conveyed products like competing metal based mechanical fastening alternatives.
- EMF maintains the same minimum pulley requirements as the belt and can operate with back bend idlers.
- It is excellent for belt applications with special backings such as Linatex, Supergrip, PVC, Fishbone, etc. EMF fits snug, which eliminates gaps otherwise seen in competing designs.
- It is suitable for belts with profiles for quick installation, saving time and money.
- EMF installs in seconds, making it the fastest timing belt installation for product conveyance. There is no need for time-consuming field welding.
- It is simple to install and requires no cumbersome or expensive field welding equipment.
- It can be custom designed according to the application strength needed. EMF can reach the same strength as the traditional welding.
- It is available on all pitches, making it a "must have" for all of your customer's conveying applications.

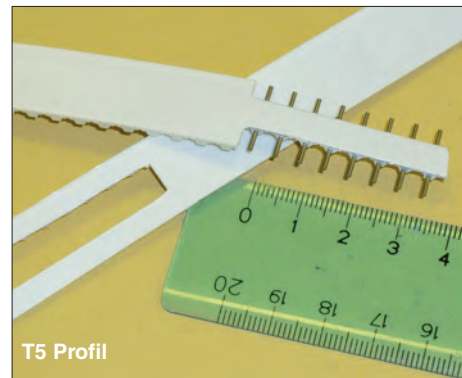
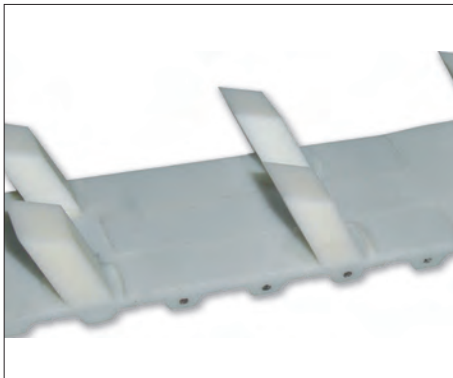

ELATECH® EMF - Module

Profile	Width [mm]	Number of pins	Max working tension [N]
T 5	10	5	96
	16	5	144
		8	224
	20	5	176
		8	232
	25	5	176
		8	256
	32	5	304
		8	450
	50	5	360
		8	480
	T 10	16	4
12			640
20		4	240
		4	304
25		8	504
		11	680
32		4	400
		8	576
50		12	880
		4	624
75		8	1120
		11	1480
100		4	800
		8	1600
100		11	1760
		4	1040
100		8	2000
		11	2280
T 20	25	4	536
		11	1600
	32	4	784
		6	1200
	50	4	960
		11	3040
75	4	1600	
	11	3560	
AT 5	10	5	144
		16	168
	16	5	168
		8	240
	20	5	280
		8	320
25	5	208	
	8	288	
32	5	320	
	8	440	
50	5	440	
	8	600	
AT 10	16	4	256
		12	960
	20	4	344
		4	384
	25	8	624
		11	904
	32	4	640
		8	800
	50	12	1200
		4	880
	75	8	1680
		11	2160
	100	4	1040
		8	2320
	100	11	2640
		4	1440
	100	8	2720
		11	3440

Profile	Width [mm]	Number of pins	Max working tension [N]
AT 20	25	4	800
		11	1760
	32	4	1200
		6	1520
	50	4	1600
		11	4400
75	4	1920	
	11	6080	
	11	6080	
HT 5	10	5	120
		5	168
	16	8	240
		5	224
	20	8	296
		5	280
	25	8	376
		5	320
	32	5	480
		8	640
	50	4	728
		8	1096
75	5	800	
	8	1520	
HT 8	15	5	256
		5	360
	20	5	376
		10	784
	25	14	960
		5	400
	30	11	960
		5	800
	50	10	1440
		14	2080
	75	5	1320
		10	2400
85	9	2320	
	5	1760	
100	10	3200	
	14	3600	
HT 14	40	5	1120
		5	1600
	55	16	-
		5	2400
	85	5	2400
		5	2400

Profile	Width [mm]	Number of pins	Max working tension [N]
RP 5	10	5	120
		5	168
	16	8	240
		5	224
	20	8	296
		5	280
	25	8	376
		5	320
	32	5	480
		8	640
	50	4	728
		8	1096
75	5	800	
	8	1520	
RP 8	15	5	256
		5	360
	20	5	376
		10	784
	25	14	960
		5	400
	30	11	960
		5	800
	50	10	1440
		14	2080
	75	5	1320
		10	2400
85	14	2880	
	9	2320	
100	5	1760	
	10	3200	
100	14	3600	
	40	5	1120
RP 14	55	5	1600
		16	-
	85	5	2400

Profile	Width [mm]	Number of pins	Max working tension [N]
ST 5	10	5	120
		5	168
	16	8	240
		5	224
	20	8	296
		5	280
	25	8	376
		5	320
	32	5	480
		8	640
	50	4	728
		8	1096
75	5	800	
	8	1520	
ST 8	15	5	256
		5	360
	20	5	376
		10	784
	25	14	960
		5	400
	30	11	960
		5	800
	50	10	1440
		14	2080
	75	5	1320
		10	2400
85	14	2880	
	9	2320	
100	5	1760	
	10	3200	
100	14	3600	
	40	5	1120
ST 14	55	5	1600
		16	-
	85	5	2400
L	12,7	4	144
	19,05	5	256
	25,4	5	288
	38,1	5	480
	50,8	5	560
	76,2	5	1000
H	101,6	5	1200
	12,7	3	120
	19,05	4	240
	25,4	4	304
	38,1	4	520
	50,8	4	640
76,2	4	880	
101,6	4	1120	

ELATECH® EFT - False Tooth System

EFT is ELATECH's mechanical profile application system specially designed for fastening cleats that cannot be welded onto polyurethane timing belts.

Zinc-coated or stainless steel teeth are available, either with our embedded tooth or total tooth design. With the total tooth design, the EFT replaces the entire tooth of the belt and is safely secured by means of two threaded holes. The embedded tooth design prevents any metal-to-metal contact, ensuring more silent operation.

Total tooth design

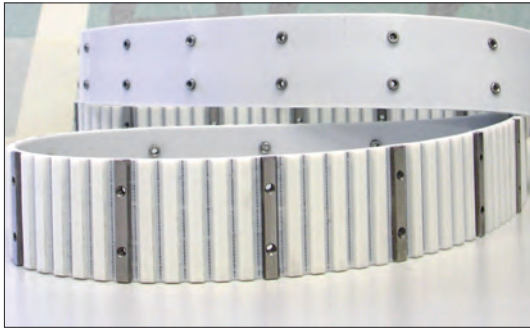

Embedded tooth design

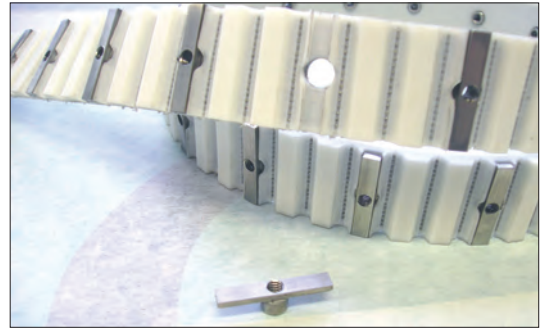

Many are the advantages offered by ELATECH® EFT:

- EFT allows to apply cleats that cannot be welded onto polyurethane timing belts because of their overall dimension and/or material (such as steel, stainless steel, plastic, urethane, wood etc.)
- EFT is in stock in stainless suitable for food and pharmaceutical industry and humid environments
- EFT design has a self-centering effect on profile positioning, which makes it more precise than welded profiles
- EFT can handle much higher loads than welded profiles, making it a strong solution
- EFT is the precise solution eliminating any welded profile positioning tolerances. The profile positioning tolerance for EFT mirrors the ELATECH® timing belt tooth pitch tolerance
- EFT is flexible, allowing customers to reposition cleats for regularly scheduled application changes
- EFT is economical because customers can replace worn profiles without having to replace the entire belt.
- EFT is available in any of the following pitches: AT10, AT20, H, XH with or without self-tracking guide.
- EFT allows to use basic belts in all their possible executions: Flex, welded, with PAZ or PAR, FDA PU, steel, aramid or stainless steel cord.

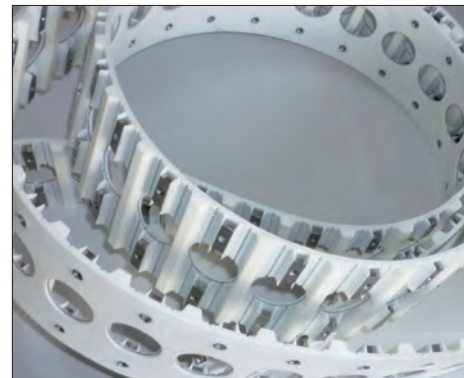
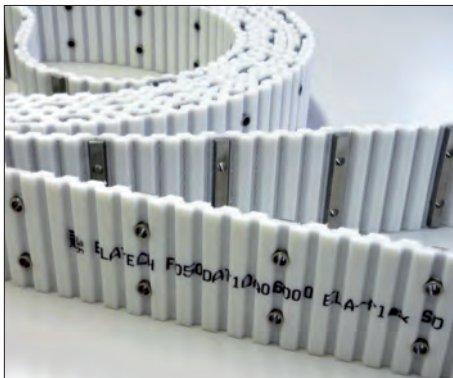

Mechanical processing

Thanks to top-quality, state-of-the-art machinery and techniques such as water jet cutting, ELATECH® timing belts can be mechanically processed to perform special and complex tasks. The extremely precise machining and finishing operations guarantee the respect of the strictest tolerance requirements and the maximum reliability of ELATECH® timing belts in all the most complex and demanding industrial applications.

Depending on the application requirements, mechanical processing may include longitudinal milling of the teeth and/or of the back, back and side grinding, teeth removal, belt surface perforation and/or engraving, as well as surface preparation for the application of special profiles.

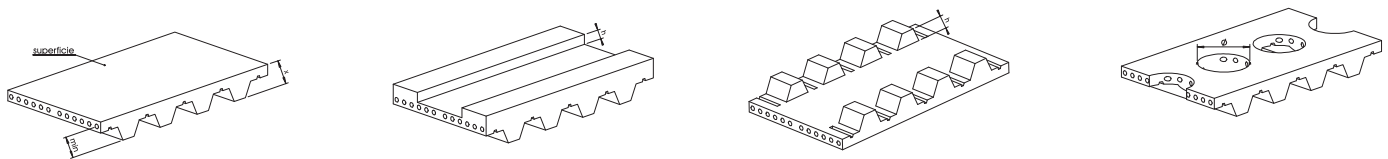

The great precision and the versatility of water jet cutting technology allow the creation of bores of any dimensions and shapes, from the smallest to the largest, from perfectly circular to oval or square.



Special backings can also be machined to optimize the performance of the belts in special applications. A typical example is the hollow milling of the backing to create a “vacuum cup effect” and maximize the suction provided by water jet cut bores. In this case, perfect suction is also granted by the absence of any tension members within the vacuum areas.

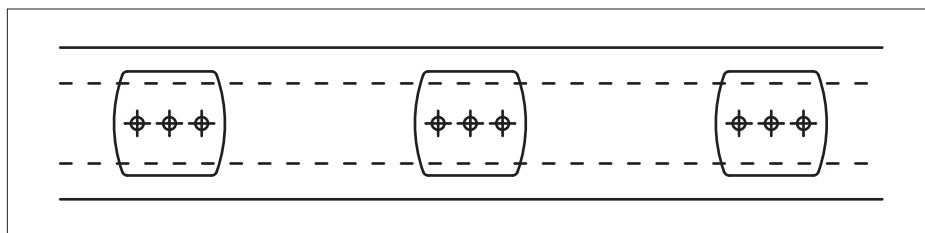

In another application, the thick V-shaped yellow PU backing on a belt used for transporting aluminium bars is slitted transversely to enhance the flexibility of the belt itself and to improve its revolution around smaller pulleys.

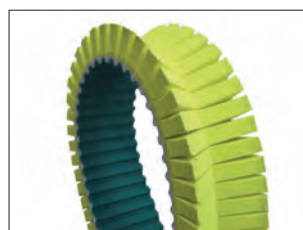

ELATECH® polyurethane belts with profiles

It is possible to attach profiles on all ELATECH®, ELA-flex SD™ and iSync™ polyurethane belts for conveying, handling and positioning applications. The cleats are produced in the same material of the belts in order to guarantee the maximum strength. The belts with profiles allow a synchronised translation of the products at very high speeds and low noise. A very wide range of profiles is available. If the required profile is not shown in the following pages, please contact our technical office.



Pitch

It is recommended to choose the pitch of the profile corresponding to the belt profile or multiple. This allows to minimize the effects of the belt overall length tolerance on profile spacing.

Position

Profile position may be over the tooth or not over the tooth. Belt Flexibility is maximized when the profiles are applied over the tooth.

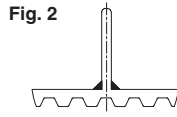
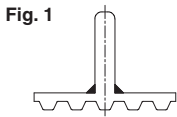

Arc of contact

It is to be noted that the belt's arc of contact may be restricted by the jointed profile. It is therefore recommended to select profiles with the minimum allowable thickness "U".

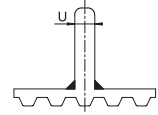
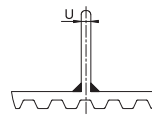

Tolerances

The tolerance of position of the profiles is +/- 0,5 mm. If required it is possible to reduce the tolerance down to +/- 0,2 mm with an extra machining. During the welding process a bead of polyurethane of about 0,5-1 mm develops at the meeting point between the profile and the belt. Should it be necessary for the application, it is possible to remove the bead with mechanical machining.

Belt type	Profile thickness "U" [mm]																								
	2	3	5	6	8	10	12	14	16	20	25	30	2	3	5	6	8	10	12	14	16	20	25	30	
Recommended minimum pulley number of teeth z																									
T5	14	20	14	30	20	45	25	50	40	60	60	100	80	-	100	-	-	-	-	-	-	-	-	-	-
T10	16	20	16	20	16	30	16	40	20	50	25	50	35	60	50	70	80	80	100	100	120	120	-	-	-
T20	20	20	18	20	18	25	18	40	18	50	20	50	25	50	30	60	40	60	50	60	70	80	-	-	-
AT5	12	20	12	30	20	45	25	50	40	60	60	100	-	-	100	-	-	-	-	-	-	-	-	-	-
AT10	18	20	18	20	18	30	18	40	20	50	25	50	35	60	50	70	80	80	100	100	120	120	-	-	-
AT20	20	20	20	20	20	25	20	40	20	50	20	50	25	50	40	40	50	50	50	60	70	80	100	100	-
XL	10	20	10	30	20	45	25	50	40	60	50	100	60	100	-	-	-	-	-	-	-	-	-	-	-
L	12	16	12	20	12	40	20	50	30	60	40	60	50	70	60	80	100	100	-	-	-	-	-	-	-
H	14	16	14	16	14	25	14	30	20	50	25	50	40	60	50	70	80	80	100	100	120	120	-	-	-
XH	18	18	18	20	18	20	18	30	18	40	20	50	20	50	25	55	35	60	50	60	70	80	-	-	-
HTD5M	12	20	12	30	20	45	25	50	40	60	60	100	80	-	100	-	-	-	-	-	-	-	-	-	-
HTD8M	18	18	18	18	18	24	18	32	18	40	20	40	28	48	40	56	64	64	80	80	100	100	-	-	-
HTD14M	28	28	28	28	28	28	28	40	28	50	28	50	28	50	30	60	40	50	50	60	100	100	110	110	-
STD5M	12	20	12	30	20	45	25	50	40	60	60	100	80	-	100	-	-	-	-	-	-	-	-	-	-
STD8M	18	18	18	18	18	24	18	32	18	40	20	40	28	48	40	56	64	64	80	80	100	100	-	-	-

Minimum number of teeth when the profile is welded on tooth gap (fig. 2)
 Minimum number of teeth when the profile is welded on tooth (fig. 1)

Ordering

When ordering it is necessary to indicate: type of belt (width, profile, pitch, length), the belt length in number of teeth, the belt and profile drawing with the number and the pitch of the requested profiles

ElaCleats

download in CAD or PDF format the most suitable cleat

ELATECH® offers a wide variety of custom-made and standard cleats specially designed for different applications in many industries. ElaCleats is a web-based tool for quickly selecting among ELATECH® standard cleats by shape, size and features. 2D and 3D drawings can be easily downloaded for the selected cleats.

Elatech online cleat selection support at:
www.elatech.com



ELA Cleats

Always up to date
 ElaCleats online version is always up to date with new types and sizes.

RELIABLE SOLUTIONS!

Fast and easy
 ElaCleats offers an intelligent search for a quick selection of most suitable cleat with an easy to follow menu for fastest navigation.

SAVE YOUR TIME!

Comprehensive range
 ElaCleats offers widest range of cleats to optimize your conveying application.

IMPROVE EFFICIENCY!

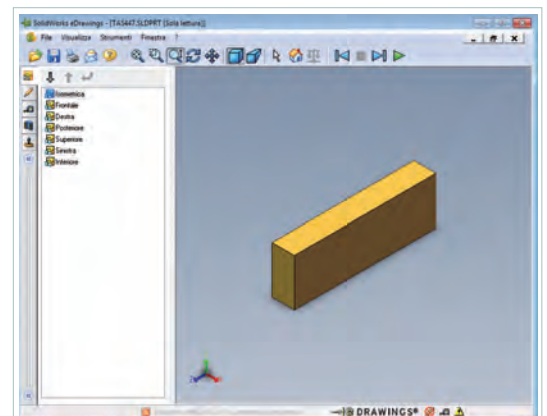

Hundreds of cleats available for all applications!



ST = Square Top: flat faces at right angles to each other



RT = Round Top: the upper part of the cleat has a rounded shape

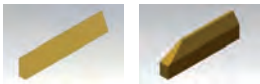

TR = Triangular or Trapezoidal: flat faces, some of which are not at right angles to other faces; cross-sections can be triangular, trapezoidal, pentagonal, etc.

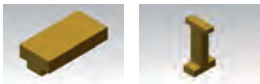

TT = "T" Shaped: a portion of the cleat (usually the upper one) is wider than the rest, so that a cross-section resembles the shape of a capital "T"

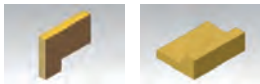

AN = Angular Shape: two portions of the cleat are set at an angle to each other



GB = Gusset Back: having a fin on one side that is not attached to the belt but rests on it and increases rigidity when the cleat is pushed in one direction



CR = Cradle Shape: "U" or "V" shaped so that an object can rest in the seat created by the sides of the cleat

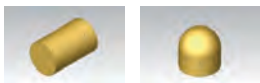

CY = Cylindrical Shape: a cylinder with vertical or horizontal axis



SP = Special Shape: any other shape, usually a structure especially designed for a specific use

ELATECH® Drive Calculation

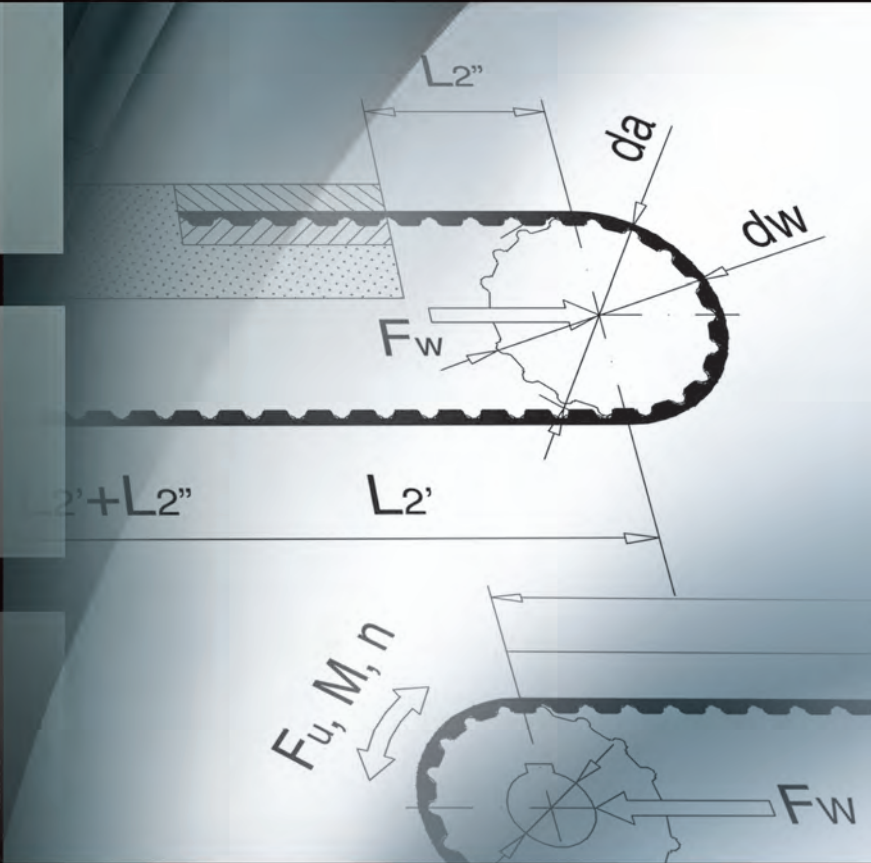

Drive calculation

guidelines

Pulleys

It is recommended to use pulleys with the maximum diameter allowed by the application in order to maximise the number of teeth in mesh and increase the belt peripheral speed. For applications where high positioning precision is required, it might be useful to use zero backlash pulleys.

In order to guarantee a reliable drive, it is recommended to use superior quality pulleys.

Minimum pulley diameter

Minimum pulley diameter depends on belt construction but also on the load and the configuration of the drive. The values reported in the catalogue have been calculated and proven for drives with maximum allowable load and standard configurations.

For drives where smaller pulleys are needed, please apply to ELATECH® technical department.

Clamping plates

In case of use of clamping plates, they must have the belt profile, be rigid and guarantee a uniform clamping force on all the surface. It is recommended to have a minimum of 7 teeth in clamp to guarantee catalogue performances. In case of belts with HPL cords, the recommended number of teeth in clamp is 12.

Machine structure

For a trouble free drive, it is recommended that the structure of application of the timing belt drive is as rigid as possible. That will guarantee high work repeatability.

Angular drives

Elatech belts can be used in angular drives as a “Twisted” drive. In such an application, it is recommended to keep a span length “ l_t ” $> 20 \cdot b$ (belt width) for 90° twist.

Omega drive

In case of omega drive application it is recommended to keep a span length between driver pulleys and idlers $> 3 \cdot b$ (belt width)

Belt life

Due to the wide application range and considering the fact that belts are one component of complex equipment, the loads in the belt itself are very seldom precisely predictable. This fact makes it impossible to confirm a precise belt service life. In order to optimize belt life of the belts, it is important to follow the catalogue technical specifications related to pulley geometry and belt storage and installation. When all catalogues specifications are followed, a belt life of 3 million reverse bending cycles occurring over 10 years can be expected. This value was measured in tests under laboratory conditions.

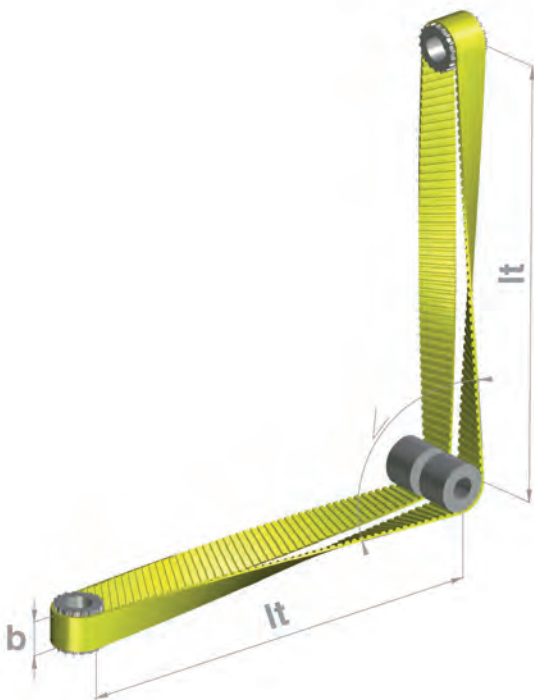

Belt installation

Drive installation

When installing belts on pulleys, before tensioning the drive, check that the belt teeth and pulley grooves correctly match.

Breaking load

Belt breaking load is highly dependent on several factors including pulley alignment, clamping system and others. The data given in the catalogue are average values tested in our laboratory. It is recommended to use adequate safety factors and ask the ELATECH® technical department for minimum guaranteed breaking load in applications where it is needed.

Belt drive tension

Correct belt drive tension and alignment are very important to optimize belt life and minimize noise level. In fact, improper tension in the belt drive will affect belt fit in the pulley grooves while correct tension minimizes belt pulley interference reducing the noise in the drive.

Drive Alignment

Pulley misalignment will result in an unequal tension, edge wear and reduction of belt life. Also, misaligned drives are much noisier than correctly aligned drives due to the amount of interference that is created between the belt teeth and the pulley grooves.

Proper pulley alignment should be checked with a straight edge or by using a laser alignment tool.

Belt width [mm]	10	16	32 over
Allowable pulley misalignment [°]	0,28	0,16	0,1

Belt handling and storage

Proper storage is important in order avoid damaging the belts which may cause premature belt failure. Do not store belts on the floor unless in a protective container to avoid damages which may be accidentally caused by people or machine traffic.

Belts should be stored in order to prevent direct sunlight and in a dry and cool environment without presence of chemicals in the atmosphere.

Avoid belt storage near windows (to avoid sunlight and moisture), near electric motors or devices which generate ozone, near direct airflow of heating/cooling systems.

Idlers

Idlers are often a means to apply tension to the drive when the centre distance is fixed but also to increase the number of teeth in mesh of the small pulley. A toothed idler on the inside of the belt on the slack side is recommended with respect to a back side idler. Drives with inside flat idlers are not recommended as noise and abnormal belt wear may occur.

- Idler location is on the slack side span of the belt drive
- Diameter for inside toothed idler must be \geq of the diameter of the small pulley in the drive
- Idler must be mounted on a rigid support
- Idlers both flat and toothed, should be uncrowned with a minimum arc of contact.
- Idler should be positioned respecting: $2 \cdot (d_{wk} + d_{wg}) < A$
- Idler width should be \geq of pulley width B

Backside idlers, however, increase the teeth in mesh on both pulleys in the drive and force a counter flexure of the belt and thus contribution to premature belt failure. When such an idler is necessary, it should be at least 1,25 times the diameter of the small pulley in the drive and it must be located as close as possible to the small pulley in the drive in order to maximise the number of teeth in mesh of the small pulley.

Do not crimp belts while handling or when stored to avoid damage to tensile cords. Belts must not be hung on small pins to avoid bending to a small diameter. Handle belts with care while moving and installing. On installation, never force the belt over the pulley flange.

ELADRIVE

online calculation software for quick and reliable drive calculation

Elatech online drive calculation support at:
www.elatech.com

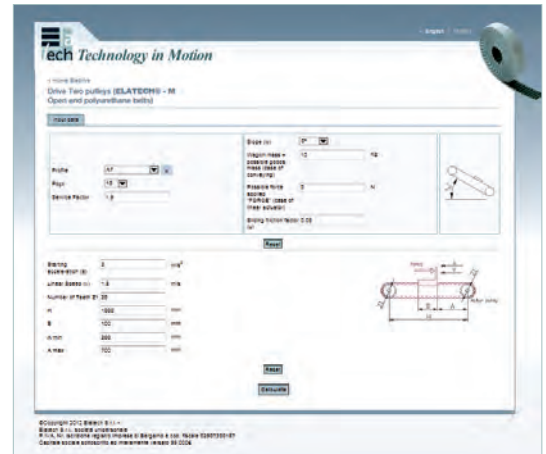

ELATECH's **ELADRIVE** is a drive calculation program allowing efficient and time saving drive calculation with improved performances.

Always up to date
ELADRIVE online version is always up to date.

RELIABLE SOLUTIONS!

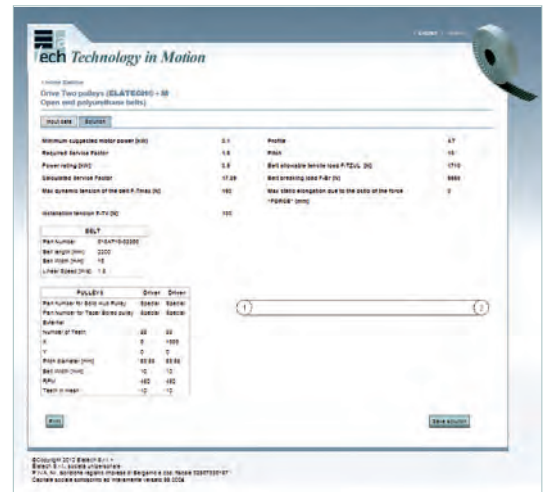

Fast and easy
ELADRIVE offers a step by step drive calculation by an easy to follow menu with improved screen layouts for quicker navigation.

SAVE YOUR TIME!

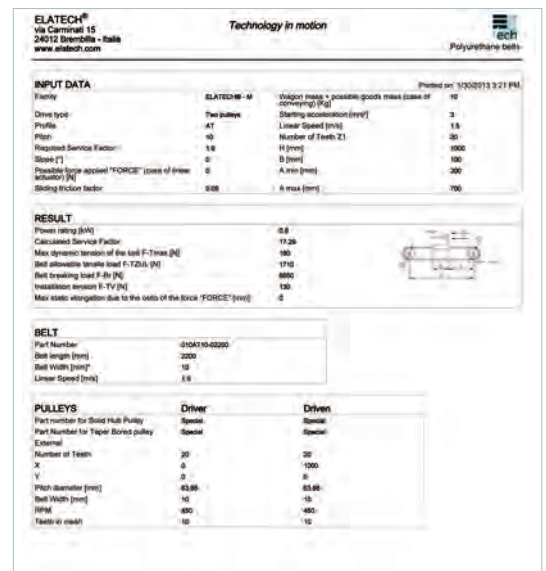

Comprehensive application range
ELADRIVE offers a drive calculation for all application technology fields: power transmission, linear, transport. Two pulley drives are calculated and multiple drive design solutions are generated.

IMPROVE EFFICIENCY!

LINEAR drives calculation

Definitions and transmission cycle

In most cases linear drives may be taken back to one of the two layouts shown, where a specific system of forces acts.

“ OMEGA “ drive

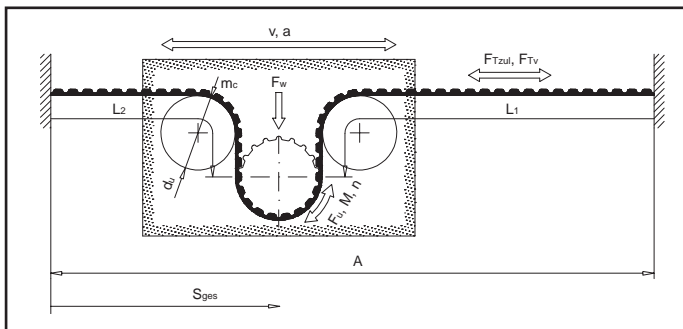

Linear drive

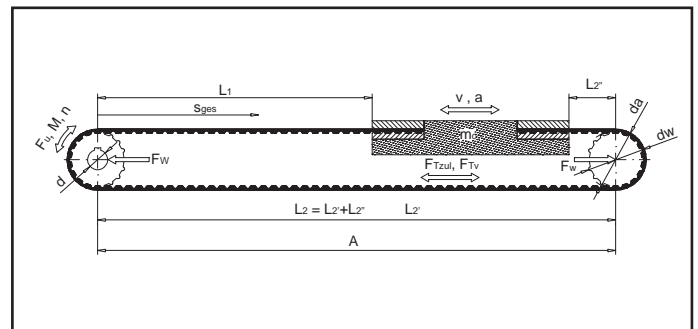

Transmission cycle (rpm/time)

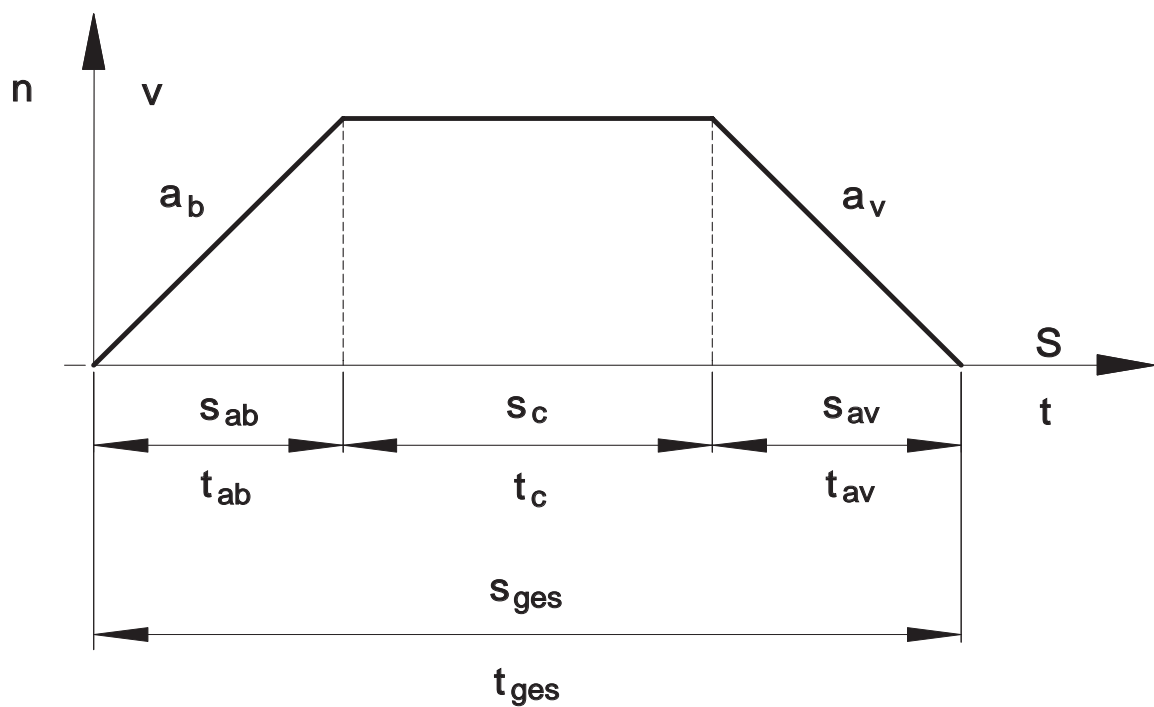

Definitions and abbreviations

a_b	[m/s ²]	Acceleration	M_{av}	[Nm]	Braking torque
a_v	[m/s ²]	Deceleration	ρ	[kg/dm ³]	Specific weight
B	[mm]	Pulley width	m	[kg]	Total mass
b	[cm]	Belt width	m_R	[kg]	Mass of belt
t	[mm]	Belt pitch	m_c	[kg]	Mass of carriage / slide
C	[N/mm]	Belt modulus / spring rate	m_S	[kg]	Pulley mass
C_{spez}	[N]	Specific spring rate	m_{Sred}	[kg]	Pulley reduced mass
A	[mm]	Centre distance	m_U	[kg]	Idler mass
A_{eff}	[mm]	Effective centre distance	m_{Ured}	[kg]	Idler reduced mass
d	[mm]	Bore diameter	n	[min ⁻¹]	Rpm
d_a	[mm]	Outside pulley diameter	n_1	[min ⁻¹]	Rpm driver pulley
d_w	[mm]	Pitch circle diameter	Δn	[min ⁻¹]	Rpm variation
d_U	[mm]	Idler pulley diameter	c_1	-	Service factor
F_{wdyn}	[N]	Dynamic shaft load	P	[kW]	Power
F_{wsta}	[N]	Static shaft load	s_{ges}	[mm]	Total travel
F_{Tmax}	[N]	Maximum span force	s_{ab}	[mm]	Travel during acceleration
F_R	[N]	Resisting force of friction	s_{av}	[mm]	Travel during deceleration / braking
F_{Uspez}	[N/cm]	Specific tooth shear strength	s_c	[mm]	Travel at constant speed
F_{Tv}	[N]	Pretension force per belt side	t_{ges}	[sec ⁻¹]	Total time of travel
F_{Tzul}	[N]	Allowable tensile load	t_{ab}	[sec ⁻¹]	Acceleration time
F_U	[N]	Peripheral force	t_{av}	[sec ⁻¹]	Deceleration time / braking time
F_H	[N]	Vertical lifting force	t_c	[sec ⁻¹]	Time at constant speed
F_{ab}	[N]	Acceleration force	v	[m/s]	Peripheral speed
F_{av}	[N]	Deceleration force	z	-	No. of teeth of pulley
g	[m/s ²]	Acceleration due to gravity (= 9,81 m/s ²)	z_k	-	No. of teeth of small pulley
Δl	[mm]	Elongation	z_g	-	No. of teeth of big pulley
Δs	[mm]	Difference of position due to force	z_R	-	No. of teeth of belt
L_1, L_2	[mm]	Length of tight and slack side	z_e	-	No. of teeth in mesh
L_R	[mm]	Belt length	i	-	Drive ratio
M	[Nm]	Torque	ω	[s ⁻¹]	Angular velocity
M_{ab}	[Nm]	Torque during acceleration	μ	-	Coefficient of friction

Calculation formula

Torque

$$M = \frac{F_U \cdot d_W}{2000} = \frac{P \cdot 9550}{n}$$

Peripheral force

$$F_U = \frac{2000 \cdot M}{d_W} = \frac{P \cdot 1000}{v}$$

Angular velocity

$$\omega = \frac{\pi \cdot n}{30}$$

Acceleration time

$$t_{ab} = \frac{v}{a_b} = \sqrt{\frac{2 \cdot s_{ab}}{a_b \cdot 1000}}$$

Braking time

$$t_{av} = \frac{v}{a_v} = \sqrt{\frac{2 \cdot s_{av}}{a_v \cdot 1000}}$$

Total time

$$t_{ges} = t_{ab} + t_c + t_{av}$$

Time at constant speed

$$t_c = \frac{s_c}{v \cdot 1000}$$

Safety factor

ELATECH® belts do not need any safety factor. However if there are unknown peaks or shock loads or swings in the peripheral force unknown at design time, which therefore can not be included in the calculation parameters, a suitable safety factor should be considered by the designer.

Steady load $c_1 = 1$

Peak or fluctuating loads:

Light $c_1 = 1,4$
 Medium $c_1 = 1,7$
 Heavy $c_1 = 2,0$

Power

$$P = \frac{M \cdot n}{9550} = \frac{F_U \cdot v}{1000}$$

Linear speed

$$v = \frac{d_W \cdot n}{19100} = \frac{n \cdot z \cdot t}{60000}$$

Rpm

$$n = \frac{19100 \cdot v}{d_W} = \frac{60000 \cdot v}{z \cdot t}$$

Acceleration travel

$$s_{ab} = \frac{a_b \cdot t_{ab}^2 \cdot 1000}{2} = \frac{v^2 \cdot 1000}{2 \cdot a_b}$$

Braking travel

$$s_{av} = \frac{a_v \cdot t_{av}^2 \cdot 1000}{2} = \frac{v^2 \cdot 1000}{2 \cdot a_v}$$

Total travel

$$s_{ges} = s_{ab} + s_c + s_{av}$$

Travel at constant speed

$$s_c = v \cdot t_c \cdot 1000$$

Calculation

Linear drives are correctly dimensioned when the total peripheral force, necessary for the requested work, satisfies the 3 technical parameters of the selected belt:

- **tooth shear strength**
- **allowable tensile load**
- **flexibility**

The necessary data for the calculation are: the mass to be moved, the transmission cycle, the drive layout with the related forces, the resisting force of friction.

Friction force is generally determined by the linear bearing manufacturer.

In case of conveying applications, it is resulting from the weight of the conveyed goods and the coefficient of friction between slider bed and belt surface. In case of accumulating conveyors the friction between the conveyed goods and the backside of the belt must be considered additionally.

Select belts and pulleys

For initial belt profile and pitch selection, use the graphs available in the related catalogue section.

For the choice of the pulleys it is recommended to use pulleys with the largest possible diameter.

That will reduce the belt width and optimise drive performances.

Calculate total mass in motion (m)

$$m = m_c + m_R + m_{Sred} + m_{Ured}$$

With:

$$m_{Sred} = \frac{m_s}{2} \cdot \left(1 + \frac{d^2}{d_a^2}\right); \quad \text{inertia of the idler timing pulley}$$

$$m_{Ured} = \frac{m_u}{2} \cdot \left(1 + \frac{d^2}{d_u^2}\right); \quad \text{inertia of the idler tensioning pulley}$$

Calculate the necessary total peripheral force F_U and torque M

$$F_U = m \cdot a_b + m \cdot g + m \cdot g \cdot \mu$$

$$F_U = F_{ab} + F_H + F_R$$

The load ($m \cdot g \cdot \sin\alpha$) must be considered only in vertical or inclined drives when a mass is lifted against gravity.

$$M = \frac{F_U \cdot d_w}{2000}$$

Determine the belt width

$$b = \frac{F_U \cdot C_1}{F_{Uspez} \cdot z_e}$$

with F_{Uspez} depending on the rpm of the small pulley (see technical data on tooth shear strength for the selected belt type).

Note: $z_{emax} = 12$ for belts ELATECH® M

$z_{emax} = 6$ for belts ELATECH® V

Determine installation pretension F_{TV}

Linear motion drives are correctly tensioned when in the slack side a minimum tension is guaranteed in all working conditions and for every value of F_{Tmax} (acceleration, deceleration).

It is recommended a pretension of:

$F_{TV} \geq F_U$ for linear drives with ELATECH® M belts

$F_{TV} \geq 0,5 \cdot F_U$ for conveying applications with ELATECH® V belts

Verify of allowable tensile load

The maximum load on the belt will appear when both the pretension F_{TV} and the working load F_U will act at the same time:

$$F_{Tmax} = F_{TV} + F_U$$

The maximum allowable tensile load of the belt F_{tzul} (see technical tables of corresponding selected belt) must be greater than the maximum working load:

$$F_{Tzul} > F_{Tmax}$$

Verify flexibility

The diameter of the chosen pulleys, must be greater or equal to the minimum recommended diameter for the specific belt profile chosen (see technical data).

Calculate shaft load

The shaft load under static conditions is:

$$F_{Wsta} = 2 \cdot F_{TV}$$

The shaft load under dynamic conditions is:

$$F_{Wdyn} = 2 \cdot F_{TV} + F_U$$

Calculate necessary static elongation

Installation tension generates a belt elongation "Δl" between the shafts (for linear drives) or the clamping plates (for "Omega" drives).

Linear drive

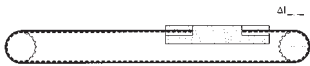

$$\Delta l = \frac{F_{TV} \cdot L_R}{2 \cdot C_{spez}}$$

"Omega" drive

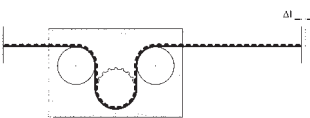

$$\Delta l = \frac{F_{TV} \cdot L_R}{C_{spez}}$$

If the resulting elongation is not acceptable for the application, it is possible to reduce it by increasing the belt width or by increasing belt rigidity (HPL cords).

Determine the positioning accuracy

The stiffness coefficient of linear drives depends on the length of slack and tight side in the drive. Every position of the system has its own stiffness coefficient calculated with the formula:

$$C = \frac{L_R}{L_1 \cdot L_2} \cdot C_{spez} \quad L_R = L_1 + L_2$$

For C_{spez} value see technical data of selected belt type.

Stiffness coefficient will be minimum when slack and tight side will have the same length during the working cycle.

$$C_{min} = \frac{4 \cdot C_{spez}}{L_R}$$

With L_R equal to the belt length free to elongate (excluding contact length on timing pulleys).

Being F_U the resulting force on the slide, the positioning deviation generated by belt elongation is:

$$\Delta_s = \frac{F_U}{C}$$

The positioning accuracy is also depending on other parameters and therefore for an accurate calculation, please consult our technical department. When positioning is reached from both directions the actual position is affected by an error caused by backlash between belt and pulley. The use of zero backlash pulleys helps reduce the positioning error.

Installation and drive pretensioning:

In order to pretension a drive it is possible to use one of the following methods:

1) Measuring elongation

ELATECH® timing belts with steel cords have a constant elongation to the maximum allowable load F_{Tzul} . Therefore the correct pretension can be set by measuring the belt elongation with a gauge and using as a reference the graph load/elongation of the selected belt type. This is a simple method but requires good accessibility of the drive.

2) Using span deflection

The pretension is checked by applying a force in the centre of the span length and measuring the span deflection

3) Measuring frequency

The tension of the belt is calculated from the natural frequency of vibration of the belt span which is measured by means of a special belt tension meter. This is the most accurate and easiest method.

A suitable belt tension meter is available from ELATECH®

Selection graphs mass / acceleration

LINEAR drives

The selection graphs **mass/acceleration**, are a useful aid to the designer for the initial selection of the belt type and width in the linear motion applications. The graphs have been designed considering the maximum speed (rpm) generally used in the applications for every belt profile and pitch and have included a safety factor increasing with the acceleration.

Therefore, depending on the specific values of the application, it might be necessary to change the belt width upon calculation.

T2,5

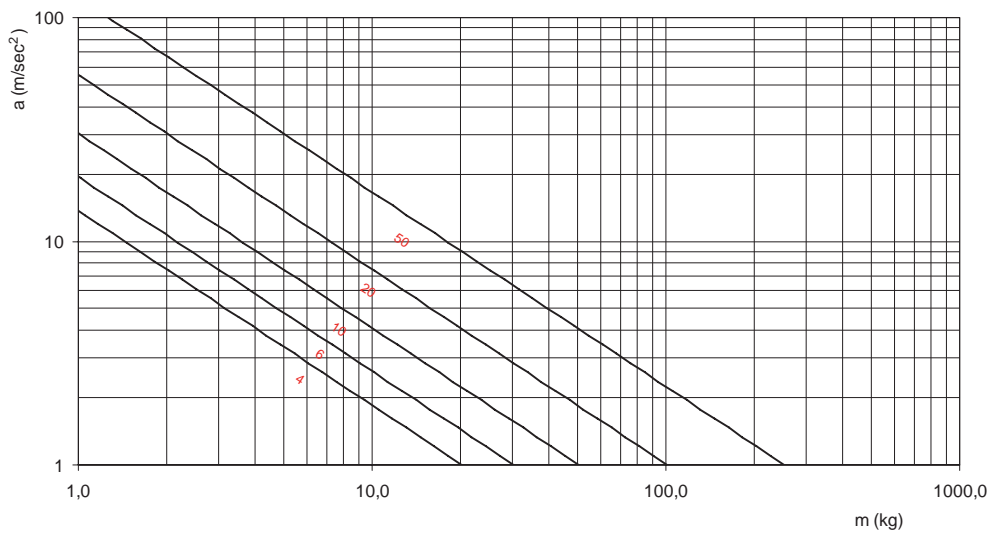

T5

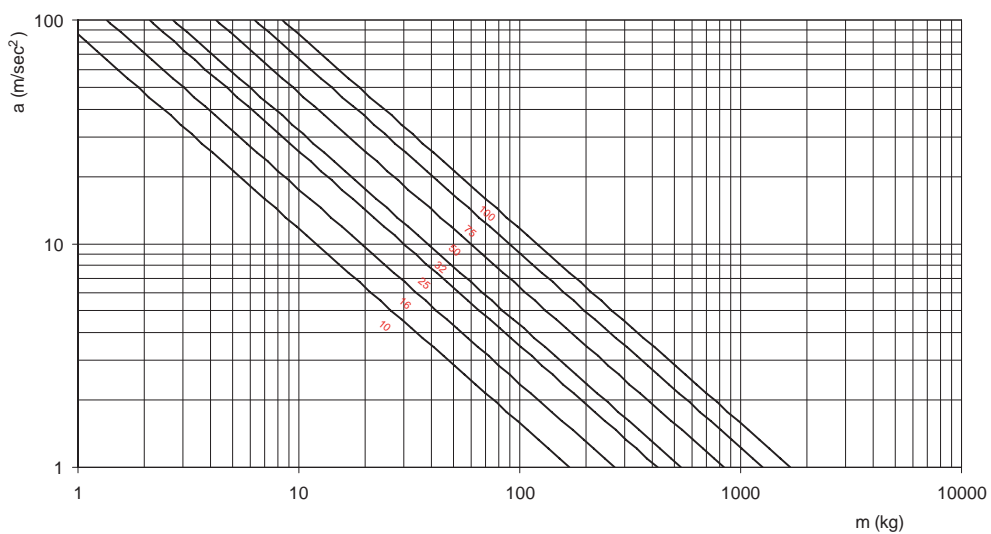

T10

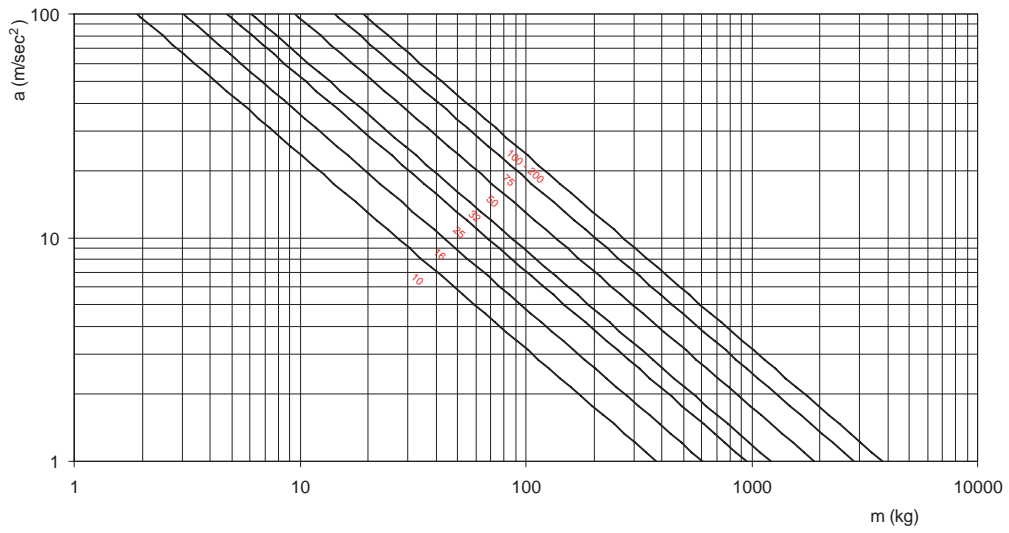

T20

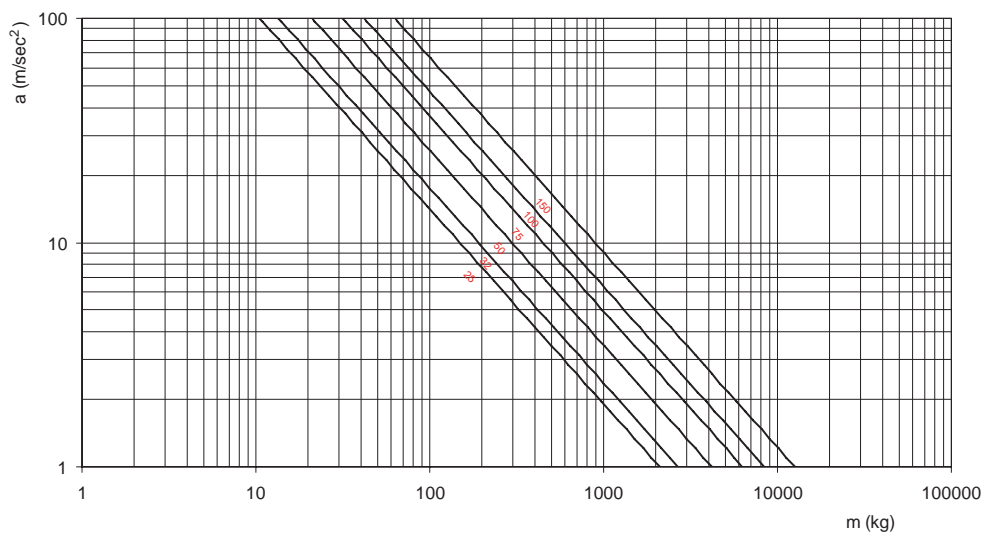

AT3

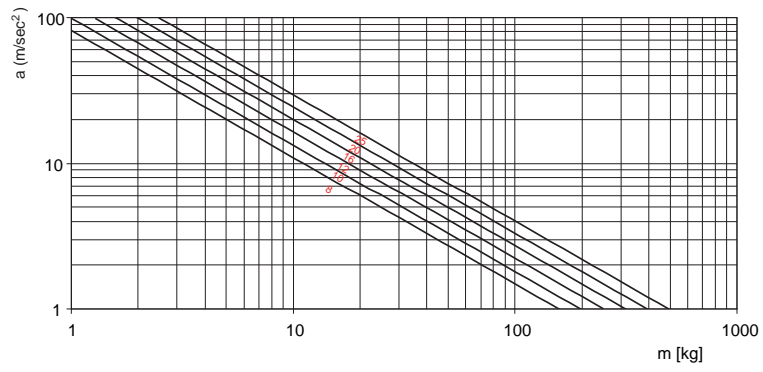

AT5 - ATL5

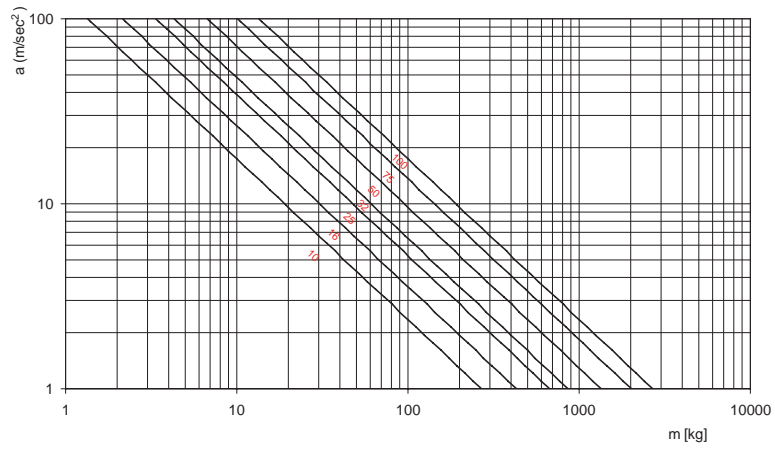

AT10 - ATL10

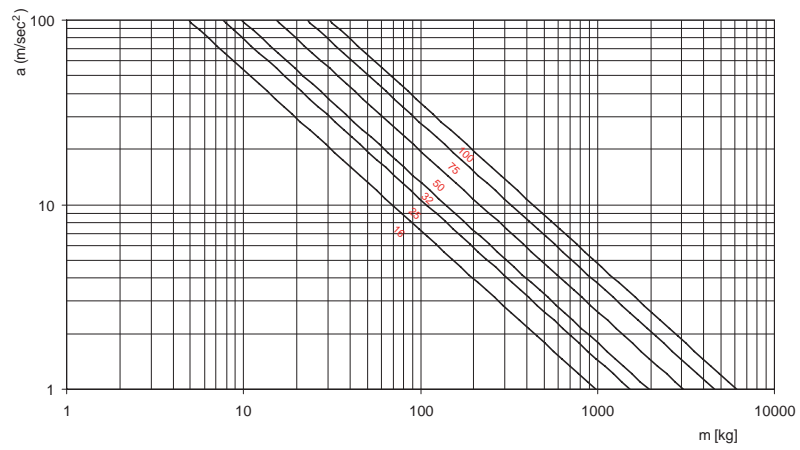

AT20 - ATL20

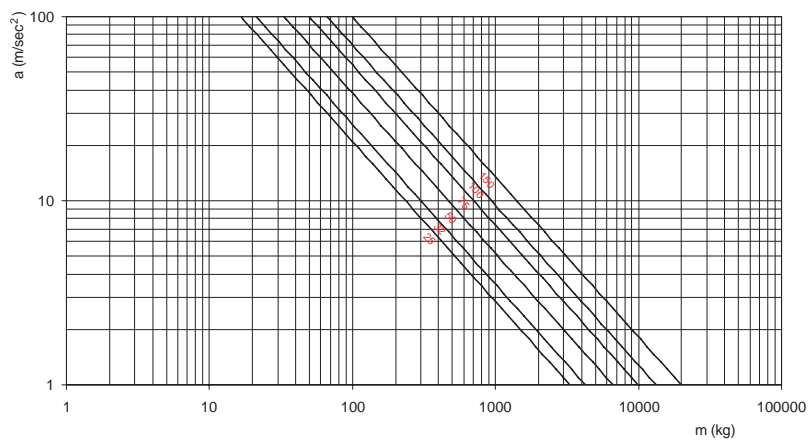

XL

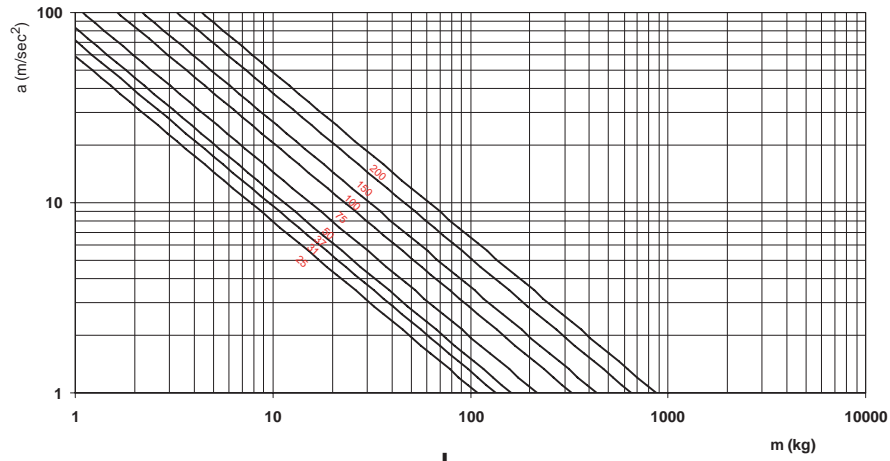

L

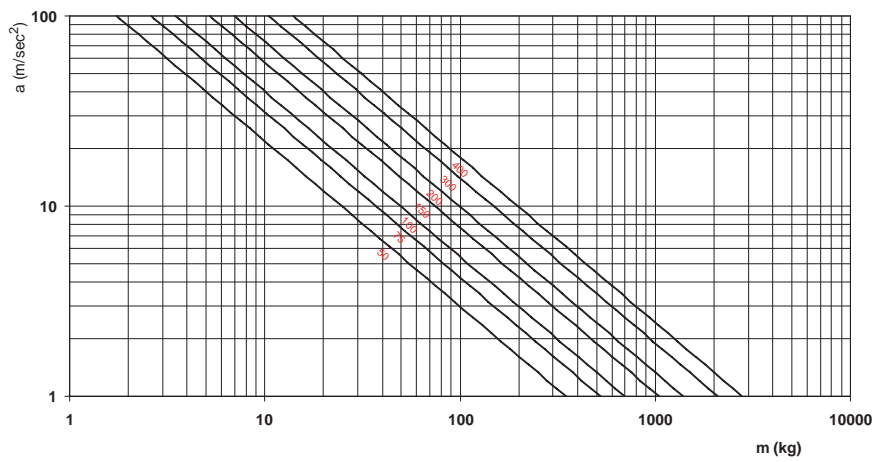

H

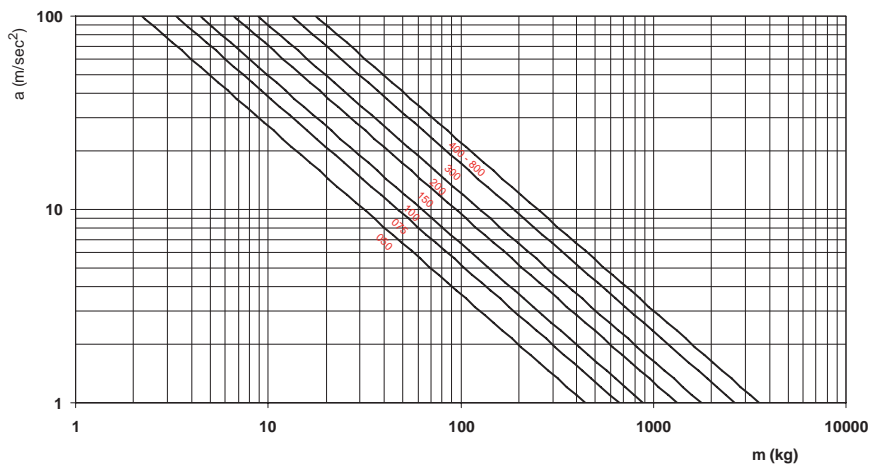

XH

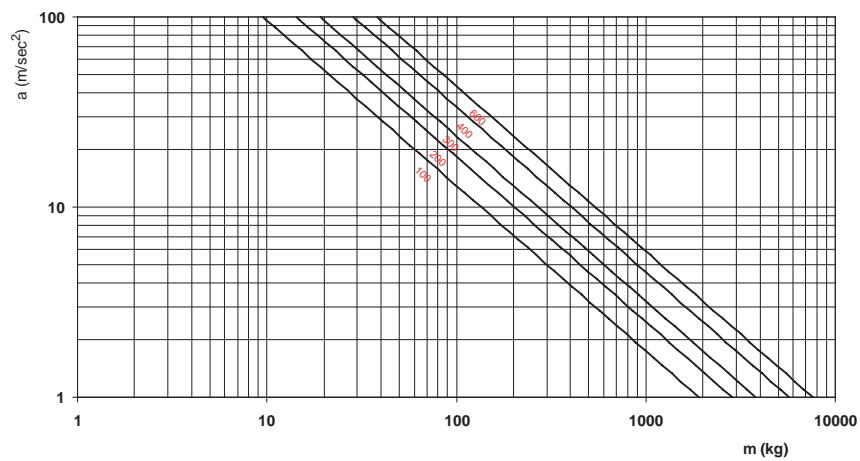

HTD3M

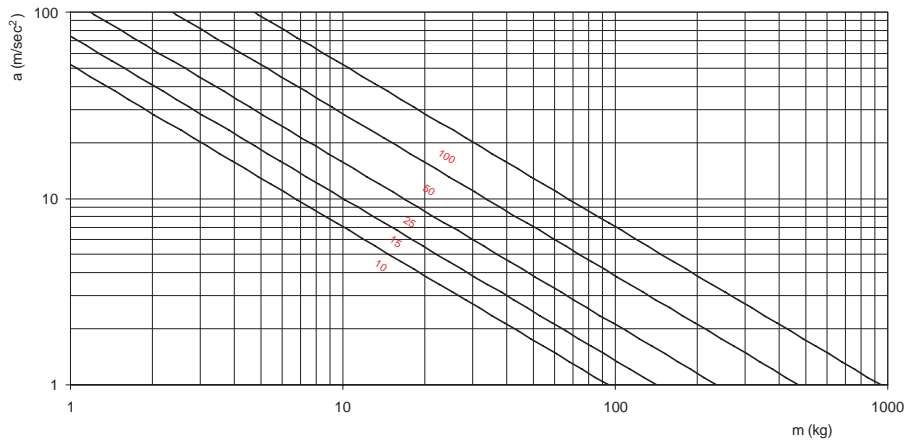

HTD5M

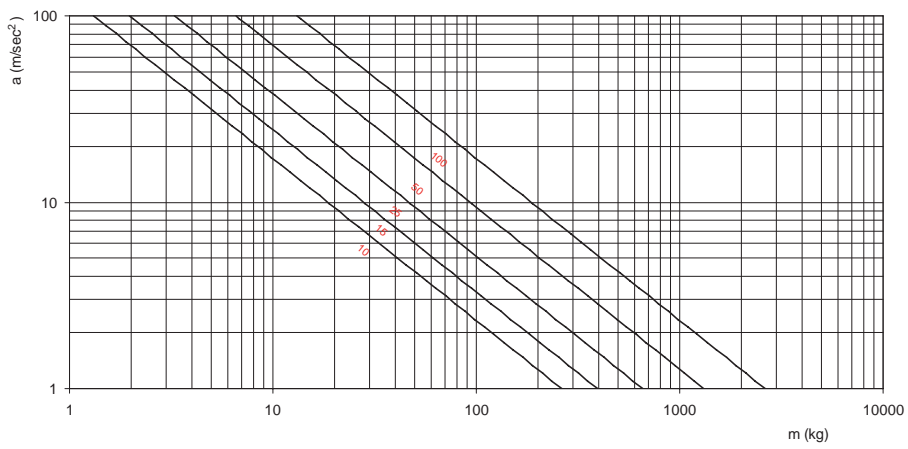

HTD8M

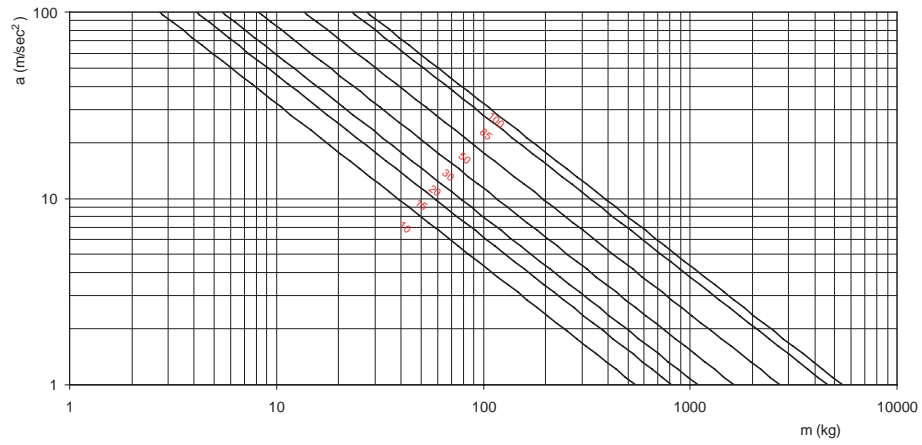

HTD14M

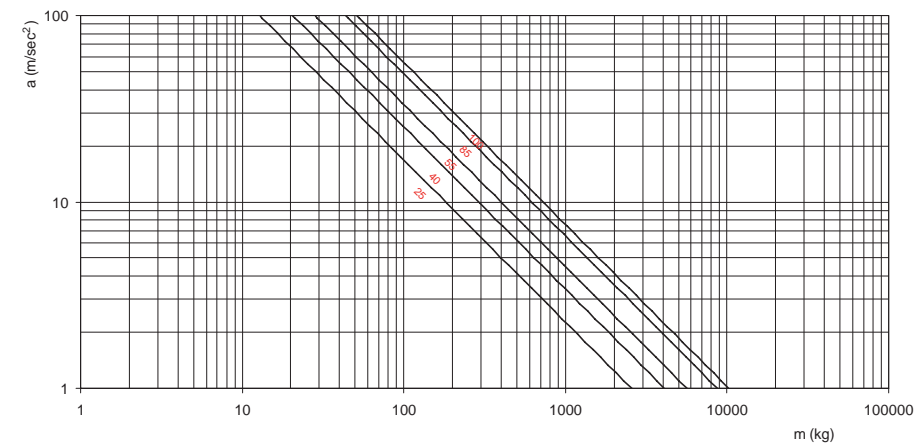

RTD5M

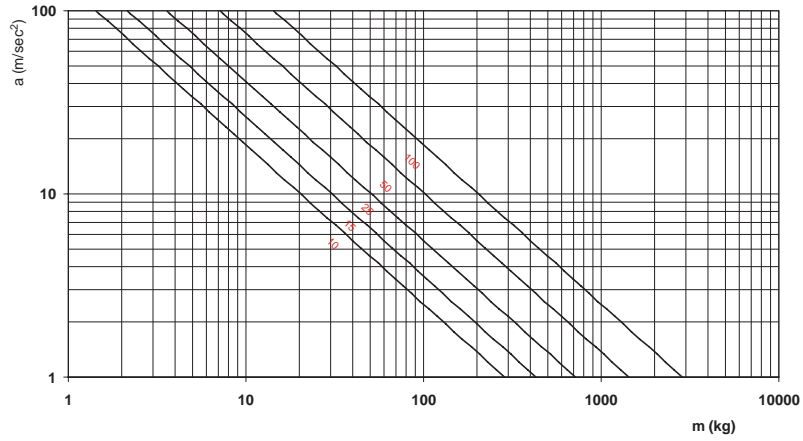

RTD8M

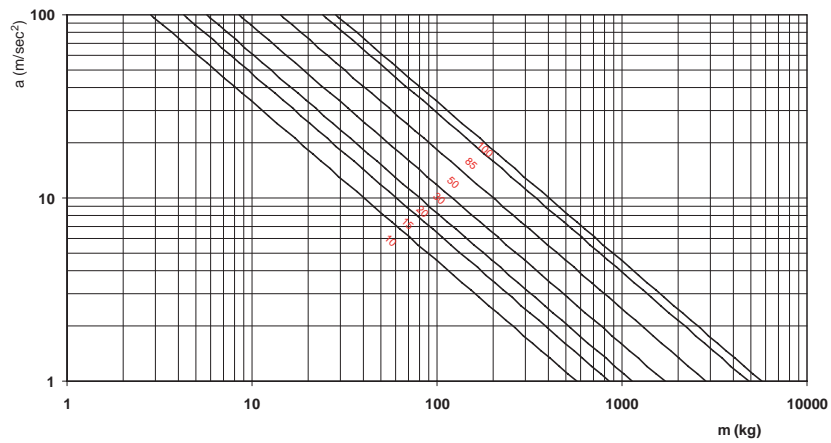

RTD14M

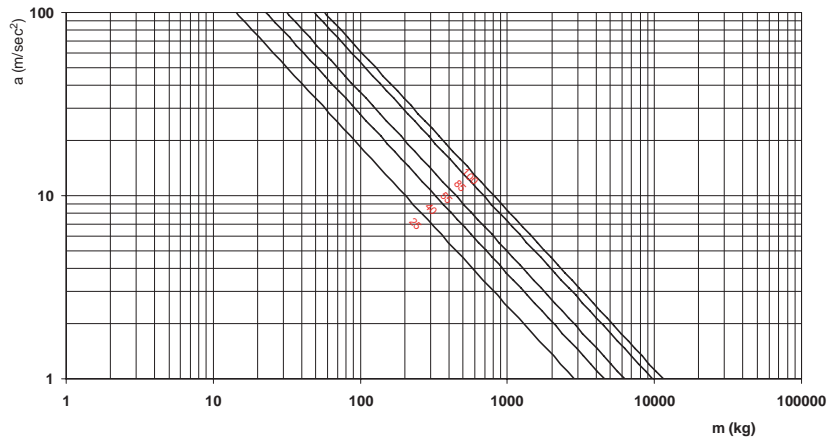

STD5M

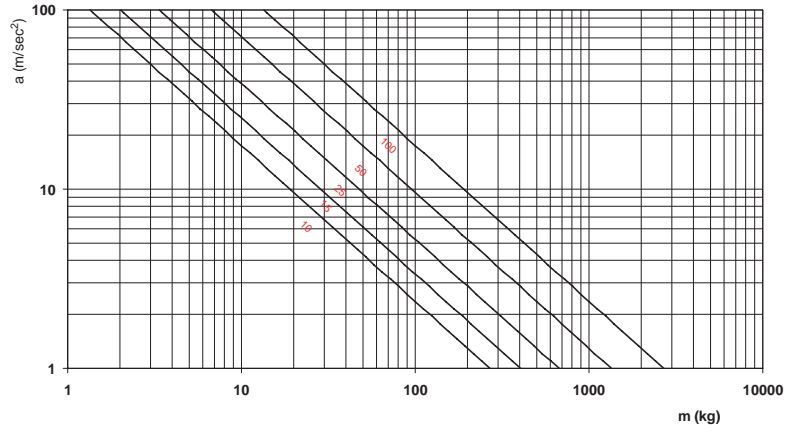

STD8M

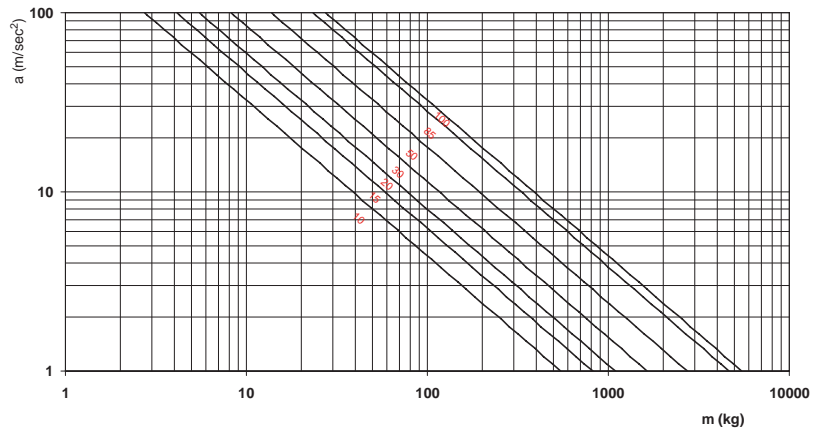

STD14M

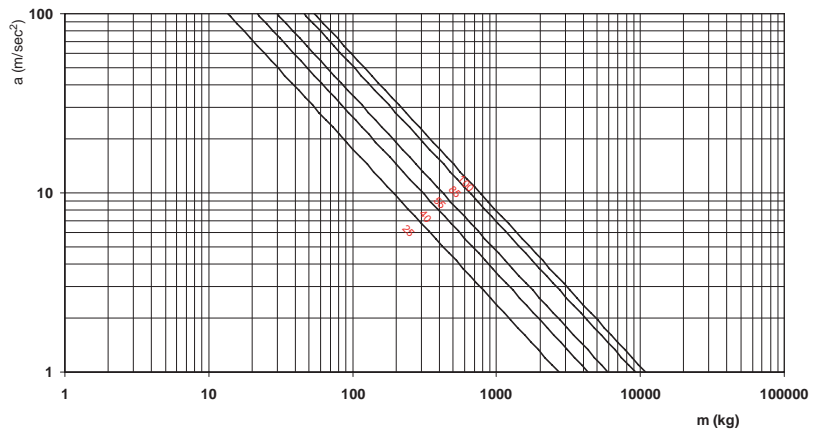

EAGLE 5M

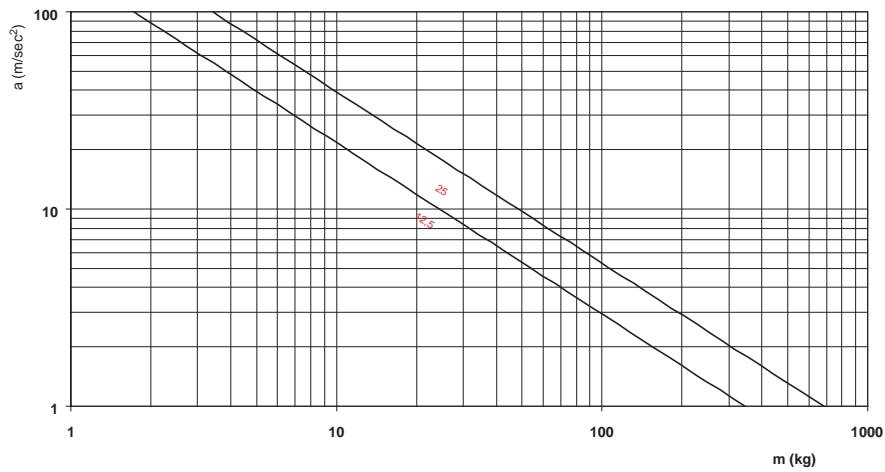

EAGLE 8M

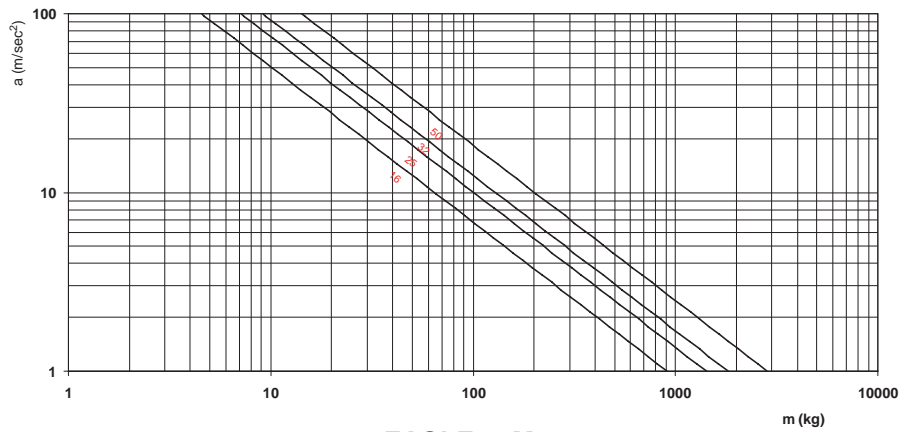

EAGLE 10M

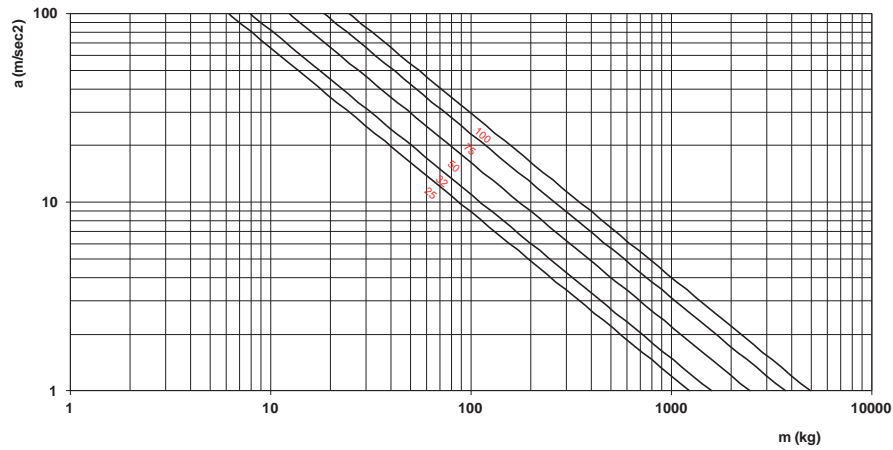

EAGLE 14M

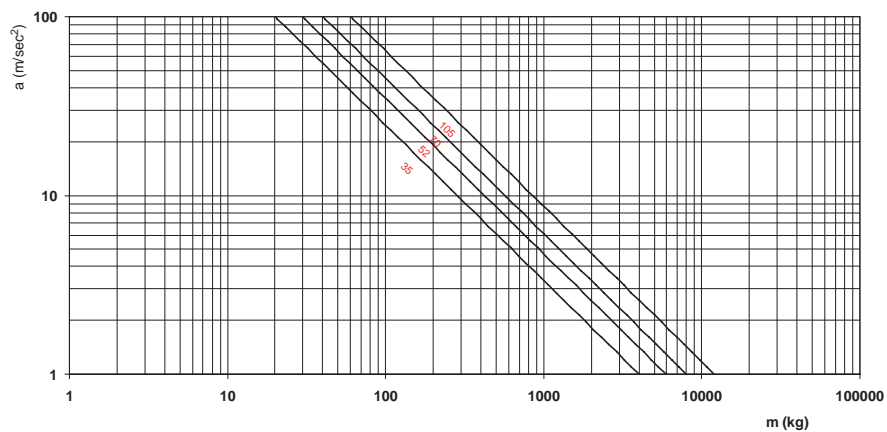

Selection graphs corrected peripheral force / belt width

LINEAR drives

The selection graphs **corrected peripheral force / belt width** provide a quick indication on the belt width needed for each belt profile when a specific corrected load is applied. The graphs have been designed considering the maximum speed (rpm) generally used in the applications for every belt profile and pitch. No safety factor is included as safety factor usually depends on acceleration. Therefore, depending on the specific values of the application, it might be necessary to change the belt width upon calculation.

T profile

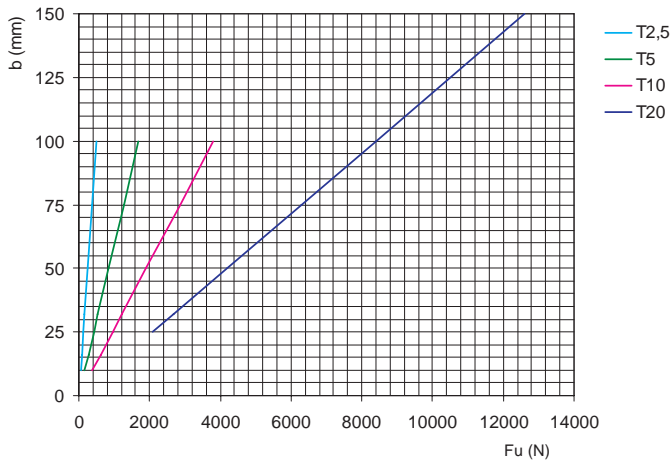

AT profile

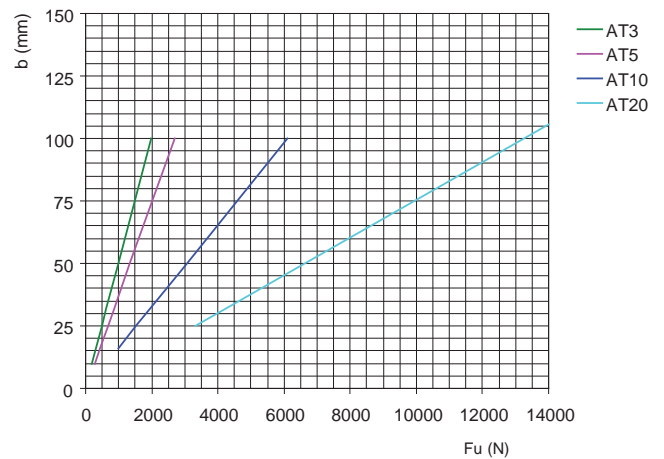

Inches Profile

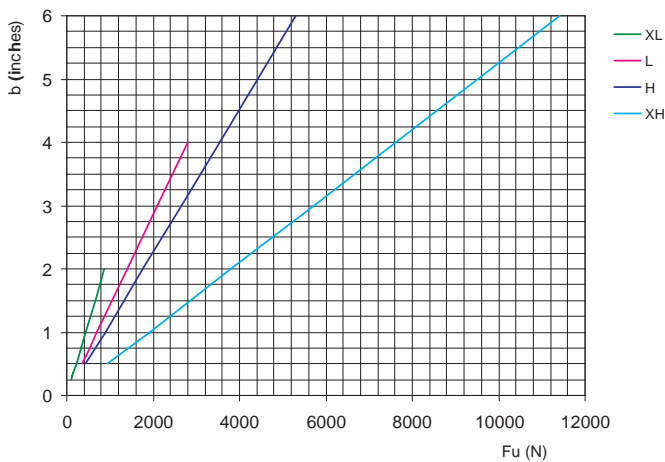

HTD profile

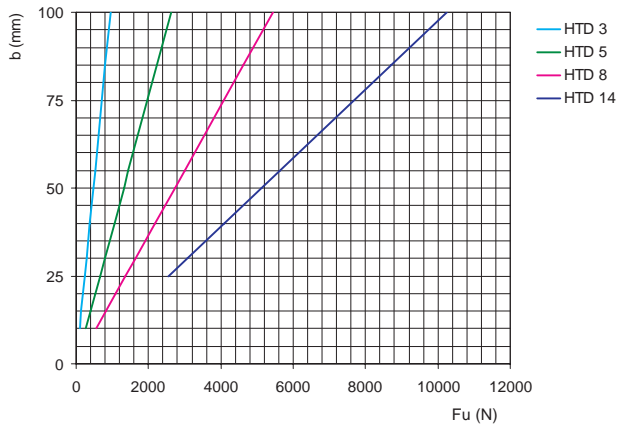

RTD profile

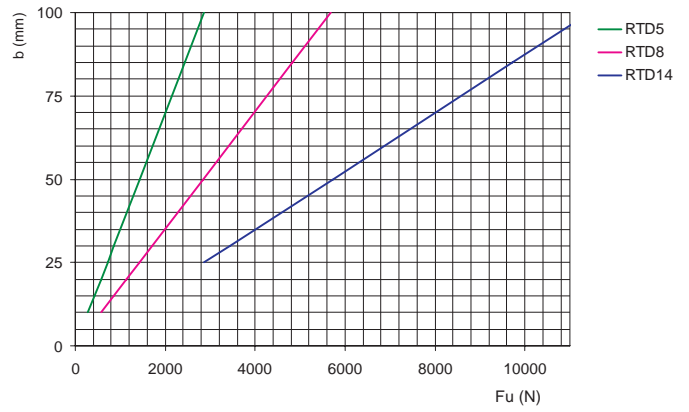

STD profile

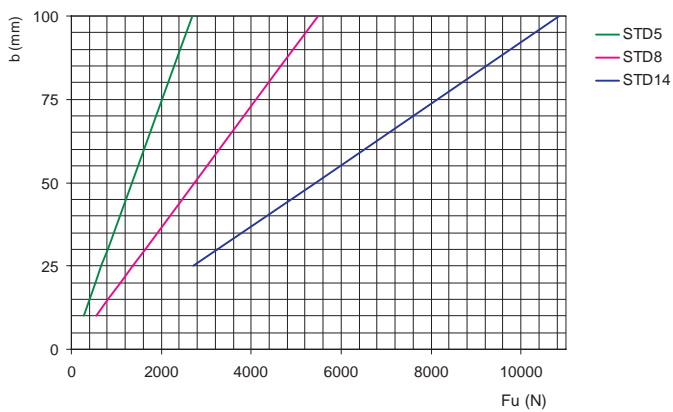

EAGLE profile

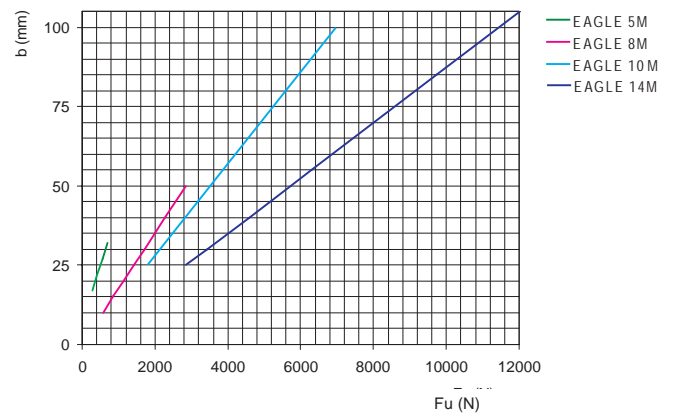

Power transmission drives ELA-flex SD™ and iSync™

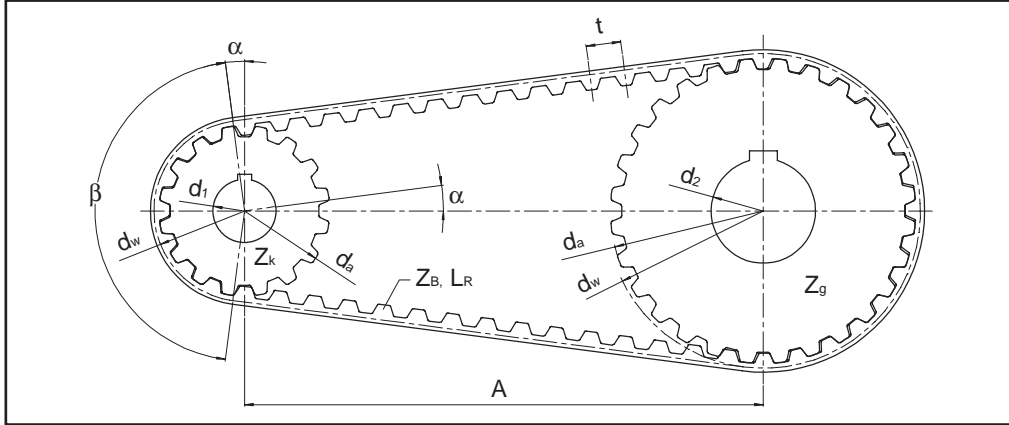

Definitions

b	[cm]	Belt width	M	[Nm]	Torque
LR	[mm]	Belt length	P	[kW]	Power
Z _R	-	Number of teeth of the belt	t _{ab}	[s]	Acceleration time
B	[mm]	Pulley width	t _{av}	[s]	Deceleration time
A	[mm]	Center distance	v	[m/s]	Peripheral speed
A _{eff}	[mm]	Effective center distance	Z _e	-	N. of teeth in mesh
d	[mm]	Pulley bore diameter	Z _k	-	Number of teeth of the small pulley
d _a	[mm]	Pulley outside diameter	Z _g	-	Number of teeth of the large pulley
d _{ak}	[mm]	Small pulley outside diameter	i	-	Drive ratio [n ₁ : n ₂]
d _{ag}	[mm]	Large pulley outside diameter	ρ	[kg/dm ³]	Specific weight
d _w	[mm]	Pulley pitch diameter	J	[kgm ²]	Moment of inertia
d _{wk}	[mm]	Small pulley pitch circle diameter	t	[mm]	Pitch
d _{wg}	[mm]	Large pulley pitch circle diameter	n	[min ⁻¹]	Rpm
F _{Wsta}	[N]	Static Shafts load	n ₁	[min ⁻¹]	Rpm of driver pulley
F _{TV}	[N]	Pretension force per belt side	ω	[s ⁻¹]	Angular speed
F _{Tzul}	[N]	Allowable tensile load	β	[°]	Wrap angle
F _U	[N]	Peripheral force			

Calculation formula

Power

$$P = \frac{M \cdot n}{9550}$$

$$P = \frac{F_u \cdot d_w \cdot n}{19100 \cdot 10^3}$$

Peripheral force

$$F_u = \frac{19100 \cdot P \cdot 10^3}{n \cdot d_w}$$

$$F_u = \frac{2000 \cdot M}{d_w}$$

Torque

$$M = \frac{F_u \cdot d_w}{2000}$$

$$M = \frac{9550 \cdot P}{n}$$

Moment of inertia

$$J = 98,2 \cdot 10^{-15} \cdot B \cdot \rho \cdot (d_a^4 - d^4)$$

Angular speed

$$\omega = \frac{\pi \cdot n}{30}$$

Peripheral speed

$$v = \frac{d_w \cdot n}{19100}$$

Acceleration torque

$$M_{ab} = \frac{J \cdot \Delta n}{9,55 \cdot t_{ab}}$$

rpm

$$n = \frac{19100 \cdot v}{d_w}$$

Safety factors

Belt selection is made according to a constant working load. For start up torque and in case of peak loads and vibrations a safety factor c_1 must be considered.

Transmission with steady load $c_1 = 1,0$

Transmission with peak or fluctuating loads:

Light	$c_1 = 1,4$
Medium	$c_1 = 1,7$
Heavy	$c_1 = 2,0$

For speed up driver factor c_2 must be considered:

$i =$ from 0,66 to 1	$c_2 = 1,1$
$i =$ from 0,40 to 0,66	$c_2 = 1,2$
$i < 0,40$	$c_2 = 1,3$

The resulting total safety factor is:

$$c_0 = c_1 \cdot c_2$$

Drive calculation

The necessary data for drive calculation are:

• Power to be transmitted	P	[kW]
• Driver rpm	n_1	[min ⁻¹]
• Motor starting torque	M_{ab}	[Nm]
• Required center distance	A	[mm]
• Maximum driver pulley diameter	d_{w1}	[mm]

Select type of belt

For the initial drive selection, use the selection graphs illustrated in the relative ELA-flex SD™ catalog section. For initial pulley choice, it is recommended to use the driver pulley with maximum diameter allowable in the application.

Calculate drive ratio

$$i = \frac{n_{\text{driver}}}{n_{\text{driven}}}$$

Calculate belt length

Belt length for drive with ratio $i \neq 1$

$$L_R \approx \frac{t}{2} \cdot (z_g + z_k) + 2A + \frac{1}{4A} \cdot \left[\frac{(z_g - z_k) \cdot t}{\pi} \right]^2$$

and more precisely:

$$L_R = 2A \cdot \sin \frac{\beta}{2} + \frac{t}{2} \cdot \left[z_g + z_k + \left(1 - \frac{\beta}{180} \right) \cdot (z_g - z_k) \right]$$

Belt length for drive with ratio $i = 1$

$$L_R = 2 \cdot A + \pi \cdot d_w = 2 \cdot A + z \cdot t$$

Calculate teeth in mesh

$$z_e = \frac{\beta}{360} \cdot z_k$$

with β [°] = wrap angle

$$\beta = 2 \cdot \arccos \left[\frac{t \cdot (z_g - z_k)}{2 \cdot \pi \cdot A} \right]$$

Determine belt width

$$b = \frac{P \cdot 1000 \cdot c_0}{z_k \cdot z_e \cdot P_{spez}} \quad b = \frac{100 \cdot M \cdot c_0}{z_k \cdot z_e \cdot M_{spez}}$$

Verify allowable tensile load

The allowable tensile load of the belt must be higher than the total corrected peripheral force.

$$F_{Tzul} > c_0 \cdot F_U \quad \text{with} \quad F_u = \frac{2000 \cdot M}{d_w}$$

Calculate shaft load

$$F_{Wsta} = 2 \cdot F_{TV} \cdot \cos \beta$$

$$F_{Wsta} = 2 \cdot F_{TV} \quad (\text{for } i = 1)$$

Determine installation tension

A drive is correctly tensioned when the belt slack side is tensioned in all working conditions. It is also important to use the minimum necessary tension to minimize shaft loads. Belt tension is dependent also on belt length L_R and its number of teeth Z_R . According to belt number of teeth, following tension is suggested:

2 shafts drive

$Z_R < 75$	$F_{TV} = 1/3 F_U$
$75 < Z_R < 150$	$F_{TV} = 1/2 F_U$
$Z_R > 150$	$F_{TV} = 2/3 F_U$

More than 2 shafts drive

$$F_{TV} > F_U$$

In order to ensure the correct drive installation tension, it is recommended to use the special belt tension meter available from ELATECH®.

Selection graphs

ELA-flex SD™

The selection graphs allows the customer to select the most suitable timing belt pitch for each belt profile and for the power to be transmitted. The rpm on the horizontal axis refers to the small pulley. The corrected power (safety factor x nominal power) is read on the vertical axis.

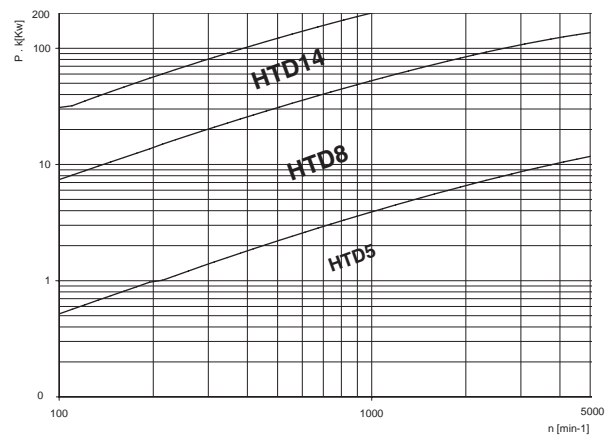
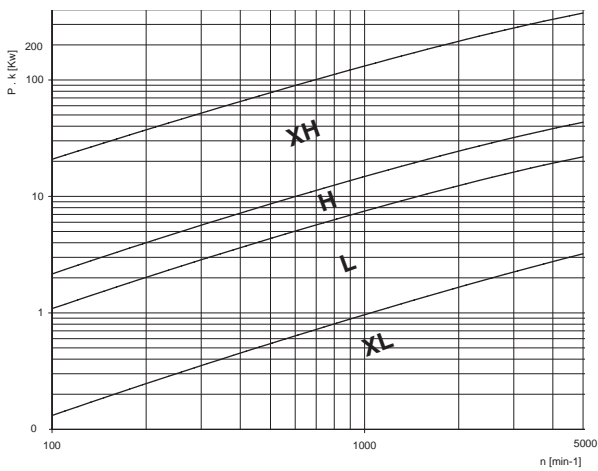
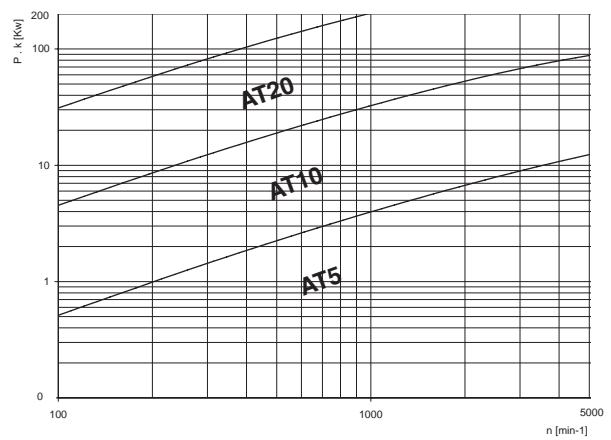
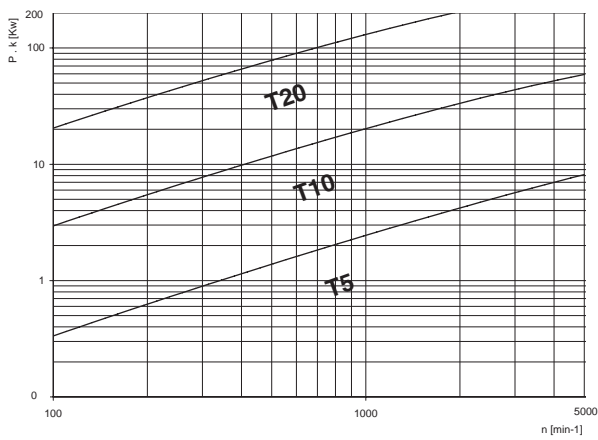

The selection graphs allows the customer to select the most suitable timing belt pitch for each belt profile and for the power to be transmitted. The rpm on the horizontal axis refers to the small pulley. The corrected power (safety factor x nominal power) is read on the vertical axis.

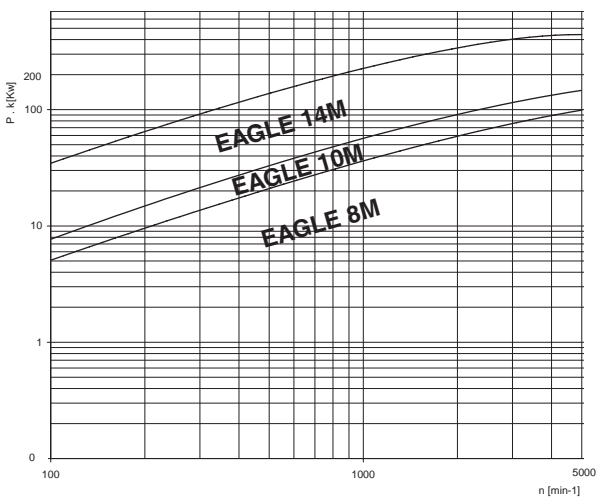
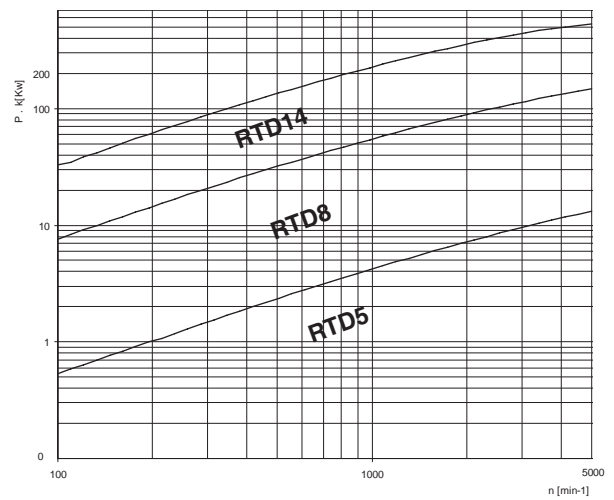
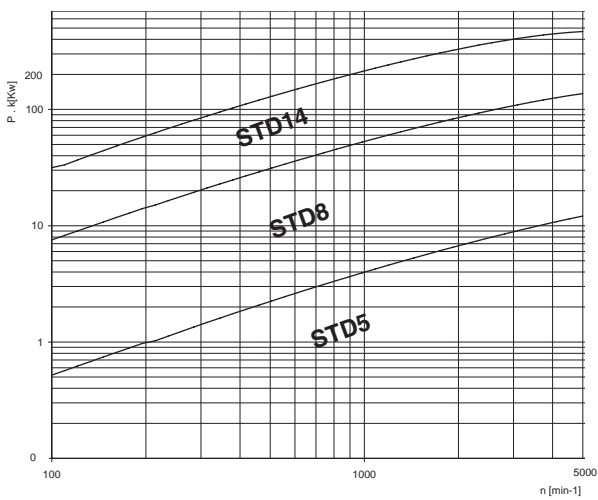

Selection graphs

iSync™ high performance timing belts

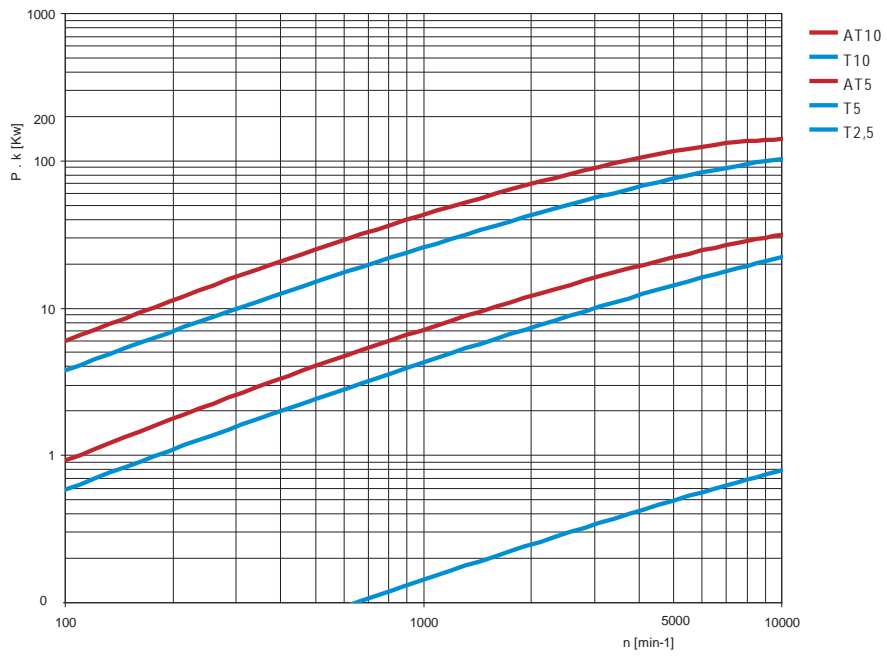

Troubleshooting

DAMAGE	CAUSE	REMEDY
Belt tooth jumping	<ul style="list-style-type: none"> Over load (shock on the machine) Overload due to machine accident Shortage of teeth in mesh Lack of initial tension Pulley diameter too small Moment of inertia for start and stop is not considered 	<ul style="list-style-type: none"> Increase belt size/modify design Prevent recurrence of the accident Increase teeth in mesh by using an idler Correct initial tension Change design Change design
Abnormal noise level	<ul style="list-style-type: none"> Bad pulley alignment Incorrect pulley tooth shape Belt wider than pulley diameter Over load Belt over-tension 	<ul style="list-style-type: none"> Adjust alignment Change pulley Change design Change design Correct initial tension
Belt side abrasion	<ul style="list-style-type: none"> Bad pulley alignment Poor flange shape Pulley flange roughness 	<ul style="list-style-type: none"> Adjust alignment Correct flange shape or change flange Change flange to an appropriate one
Belt tooth abrasion	<ul style="list-style-type: none"> Presence of particles between belt and pulley Over load Over tension Belt tooth jumping due to lack of initial tension 	<ul style="list-style-type: none"> Improve environment or apply a protective cover Change design (increase belt size) Correct initial tension Correct initial tension
Belt tooth bottom abrasion	<ul style="list-style-type: none"> Bad pulley profile Over tension 	<ul style="list-style-type: none"> Use correct pulley Correct initial tension
Belt back abrasion	Contact with undesired element (i.e. machine frame)	Eliminate contact
Belt back cracking	<ul style="list-style-type: none"> Running under too low temperature Pulleys too small 	<ul style="list-style-type: none"> Increase environment temperature or ask for special compound Observe minimum pulley diameter recommendations
Belt breakage	<ul style="list-style-type: none"> Over load (shock on the machine) Undesired particles in mesh Tension member corrosion Belt run off over pulley flange Not enough belt teeth in clamping plate Clamping plate screws tightened incorrectly 	<ul style="list-style-type: none"> Increase belt size/modify design Improve environment or apply a protective cover Improve environment or use aramid/stainless steel cords Adjust alignment and change pulley flange Use larger clamping plate Apply optimum torque to clamp plate screws
Tension member partial tear	<ul style="list-style-type: none"> Presence of undesired particles in mesh Improper installation Belt folded or twisted Fatigue on side due to bad alignment 	<ul style="list-style-type: none"> Improve environment or apply a protective cover Exercise care when installing Exercise care in handling Correct alignment
Back covering abnormal abrasion	Aggressive environment	Change belt back cover or improve environment conditions
Pulley tooth abrasion	<ul style="list-style-type: none"> Presence of undesired particles in mesh Over load Belt over tension Pulley material not adequate (too soft) 	<ul style="list-style-type: none"> Improve environment or apply a protective cover Change design Correct initial tension Change pulley material or adopt surface treatment

Notes:

A series of horizontal dotted lines for taking notes, spanning the width of the page.

Notes:

A large area of the page is filled with horizontal dotted lines, providing a space for handwritten notes.



ELATECH S.R.L.

Via Fonte Solforosa, 1 - 24012 Val Brembilla (BG) - Italy

Tel. +39.0345330311 Fax +39.0345330330

www.elatech.com - info@elatech.com

