

Unity Systems



» General information

Item	Value
Material	CPS-Amid(PA6+GF), RoHs
Speed	3~5m/s
Acceleration	10~15m/s ²
Temperature	-30°C ~+130°C
Color of Unity Systems	Yellow, Black
Certificate	CE, ATEX(Ex)

» Available Product list with Unity systems

Product Model	Value
Shift Chain Normal	ST044N, ST055N, ST072N, ST095N, ST120N
Shift Chain Enclosed	ST044E, ST055E, ST072E, ST095E, ST120E
nsb Chain Clean room	nsb020CR, nsb022CR, nsb028CR, nsb035CR, nsb045CR, nsb060CR, nsb075CR
nsb Chain Normal	nsb028N, nsb035N, nsb045N, nsb060N, nsb075N
nsb Chain Enclosed	nsb028E, nsb035E, nsb045E, nsb060E, nsb075E

» Unity system Application method » Cable Chain Calculation table

Item	Value
Vertical type	Only 1 set of GC.FEB (End bracket) and 1 pcs of GC.EC(End cap)
Horizontal type	1 set of GC.FEB + 1 pcs of GC.EC(End cap) + ½LS of GC(Guide channel)

Item	Value
Length of Cable Chain	$L = \frac{1}{2} * LS + LP$
Bending Radius	
- The biggest Cable inserted	Multiply 8 ~ 10 and the biggest cable
- The biggest Hydraulic Hose inserted	Multiply 15 ~ 20 and the biggest hose

- Horizontal type example

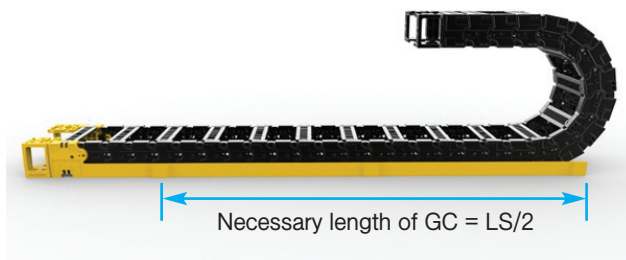

» Part list of Unity systems

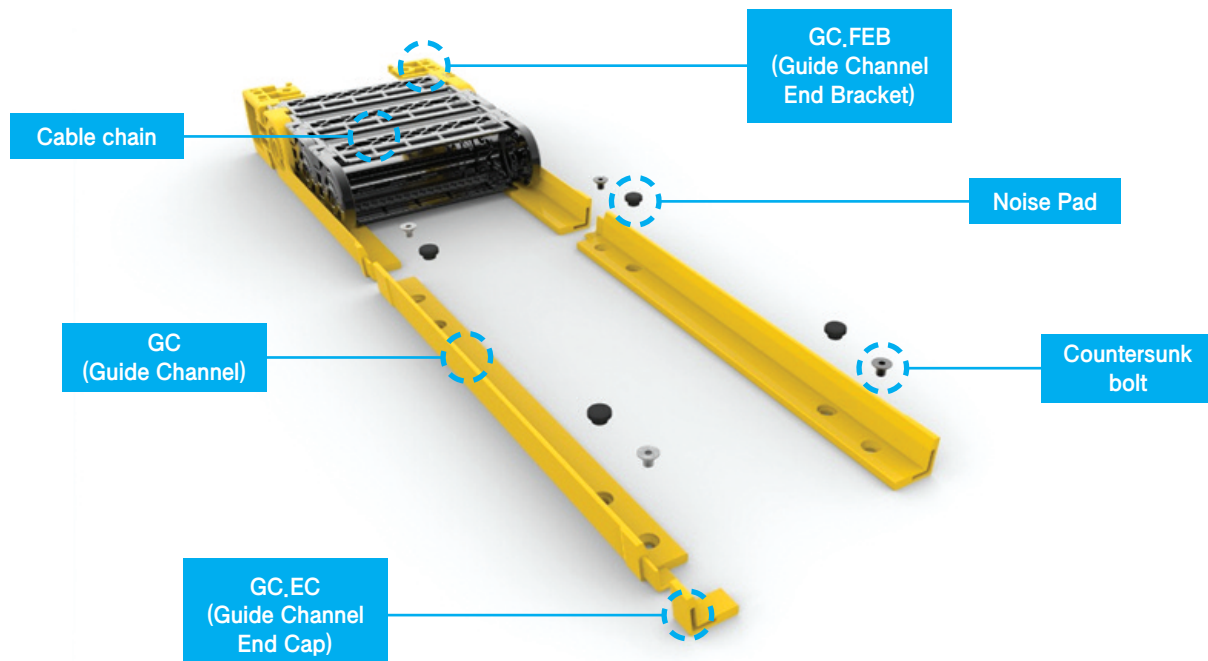

Unity Systems

» Characteristics of Unity systems

1 To protect cable at vertical application!

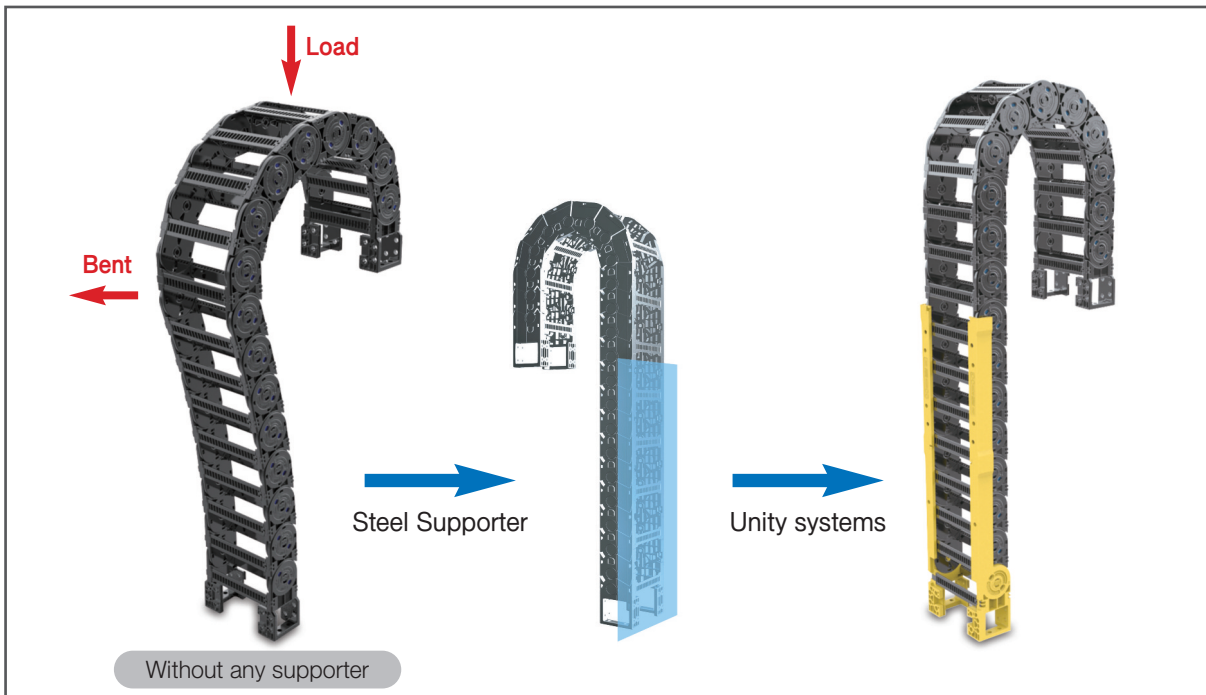

2 Cost saved as it's made by high quality PA6 to replace steel supporter or steel guide channel!

- Cost-saving effect by using the plastic material, compared to previous expensive material such as stainless steel & aluminium.
- Time-saving effect of installation by all-in-one composition.
- No need to spend extra cost when connecting it with cable chain.
- Can shorten delivery because the extra designing process is unnecessary.
- Installation with only the parts is feasible.

» Assembly procedure of Unity systems

The assembling procedure of Unity Systems Chain is like below and you must use rubber hammer with careful combination of Divider and Separator.



1

Prepare cable chain that guide channel attached end bracket is assembled to. It is a same assembling method between existing cable chain and FEB.

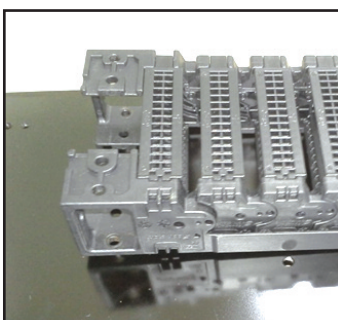

2

Connect cable chain that guide channel attached end bracket is assembled to extended form of guide channel and equipment where end cap is assembled. And connect them with bolts.



3

Completed figure of cable chain.

Can attach rubber pad for noise protection to the surface of guide channel.

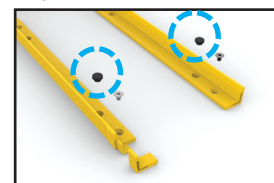

ST044N - Unity Systems

» Unity system Application method

Item	Value
Vertical type	Only 1 set of GC,FEB (End bracket) and 1pcs of GC,EC(End cap)
Horizontal type	1set of GC,FEB + 1pcs of GC,EC(End cap) + ½LS of GC(Guide channel)

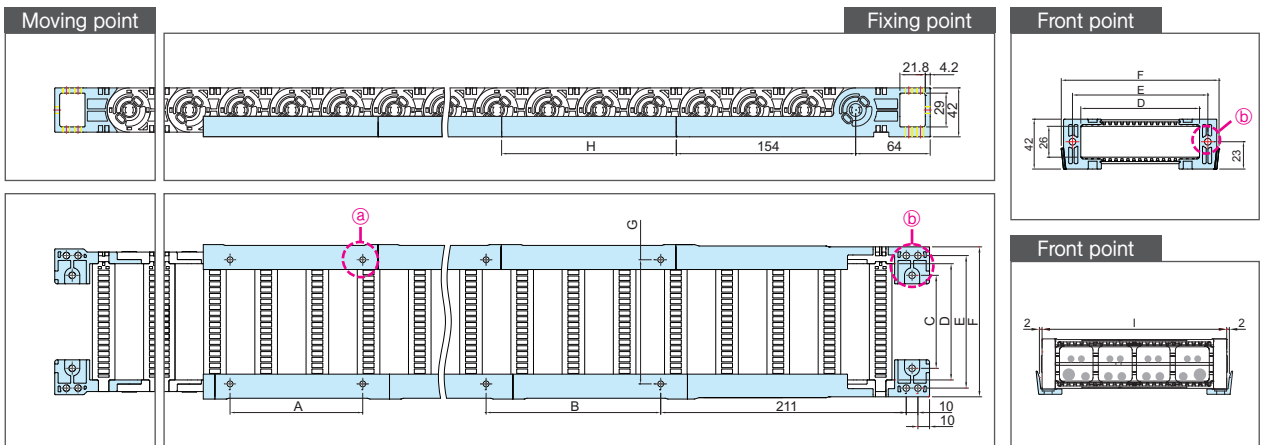
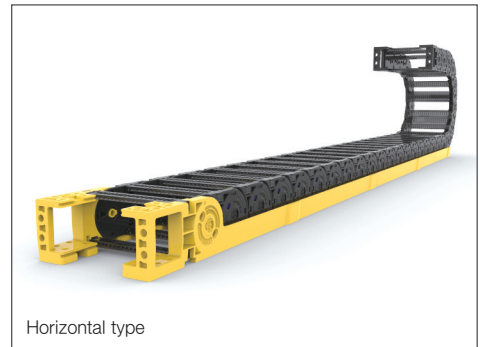
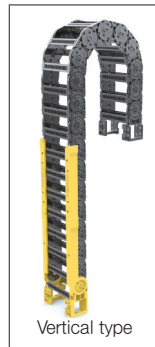

Chain Type	C FEB fix hole(inner)	D Frame	E FEB hole width	F FEB width	G GC hole width	I FEB width
ST 044N	15	35	49	68	41.8	56
	30	50	64	83	56.8	71
	35	55	69	88	61.8	76
	55	75	89	108	81.8	96
	80	100	114	133	106.8	121
	105	125	139	158	131.8	146
	130	150	164	183	156.8	171
	155	175	189	208	181.8	196
180	200	214	233	206.8	221	

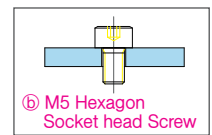
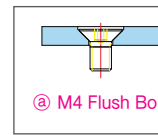

GC Type	H GC length	B GC fixing hole	A GC hole
GC150	150	151	114
GC250	250	251	214

(Dimensions in mm)

» Ordering

ST 044N, 100, R120 / F - 1500L : 10ST

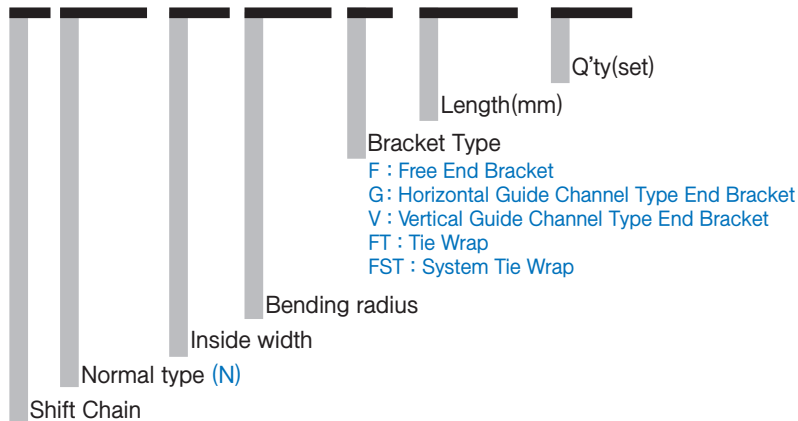

ST055N - Unity Systems

Unity system Application method

Item	Value
Vertical type	Only 1 set of GC,FEB (End bracket) and 1pcs of GC,EC(End cap)
Horizontal type	1set of GC,FEB + 1pcs of GC,EC(End cap) + ½LS of GC(Guide channel)

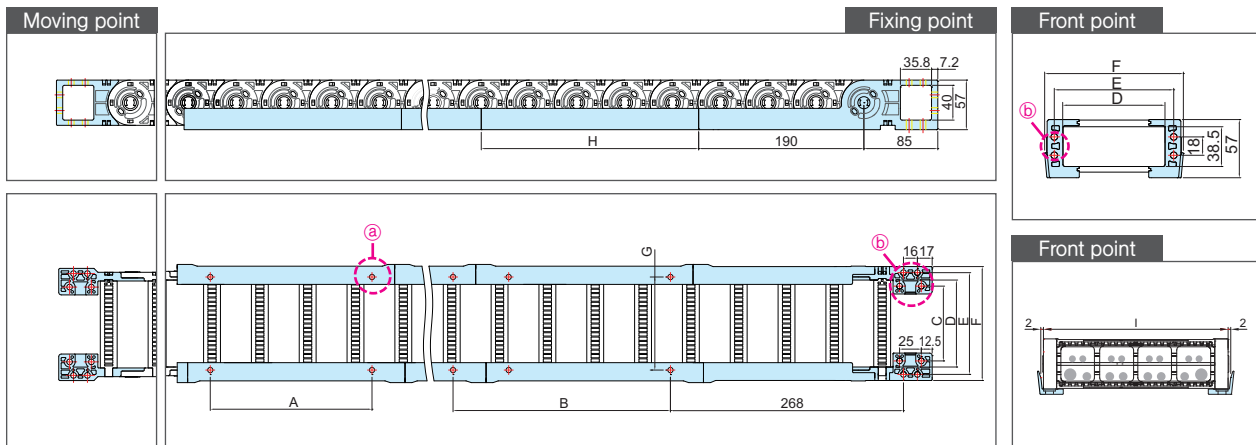
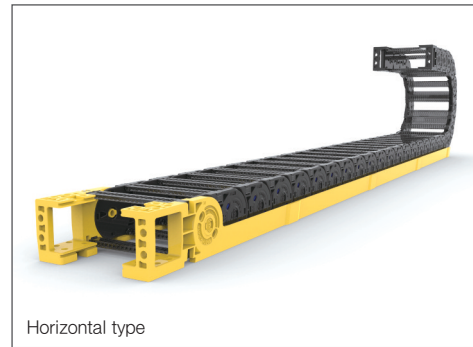
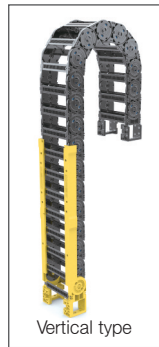

Chain Type	C FEB fix hole(inner)	D Frame	E FEB hole width	F FEB width	G GC hole width	I FEB width
ST 055N	21	35	52	71	42	56
	36	50	67	86	57	71
	41	55	72	91	62	76
	61	75	92	111	82	96
	86	100	117	136	107	121
	111	125	142	161	132	146
	136	150	167	186	157	171
	161	175	192	211	182	196
186	200	217	236	207	221	

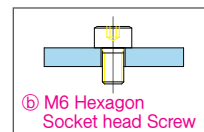
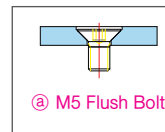

GC Type	H GC length	B GC fixing hole	A GC hole
GC250	250	251	186
GC400	400	401	336

(Dimensions in mm)

Ordering

ST 055N, 150, R150 / F - 1800L : 10ST

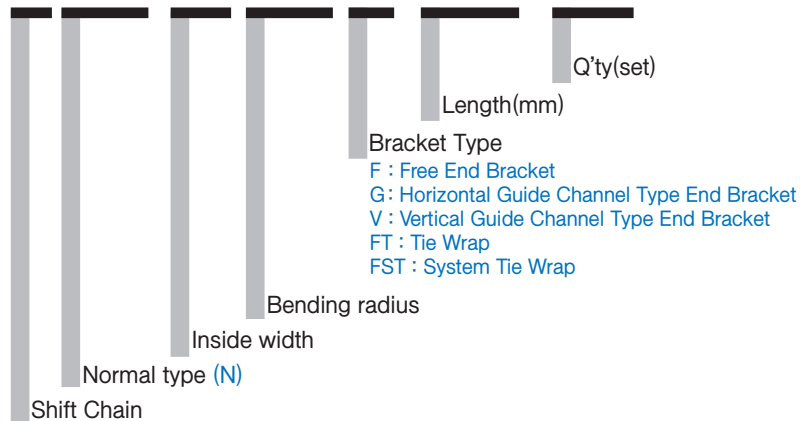

ST072N - Unity Systems

» Unity system Application method

Item	Value
Vertical type	Only 1 set of GC,FEB (End bracket) and 1pcs of GC,EC(End cap)
Horizontal type	1set of GC,FEB + 1pcs of GC,EC(End cap) + ½LS of GC(Guide channel)

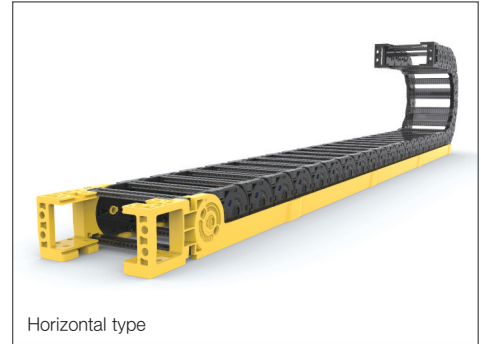
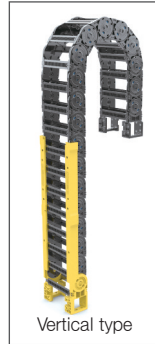

Moving point

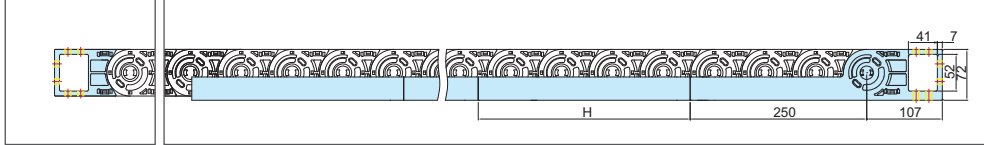

Fixing point

Front point

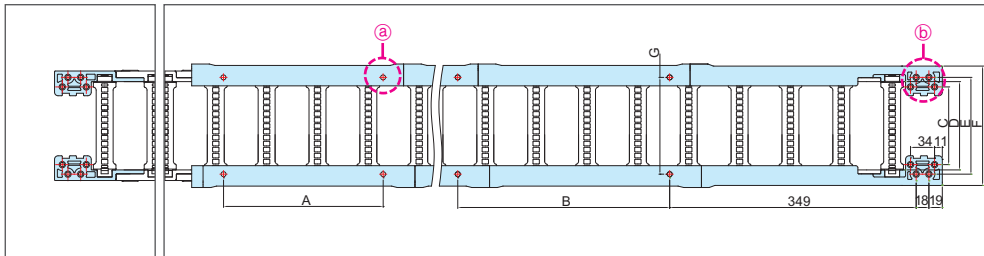
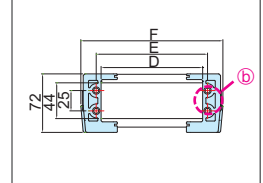

Front point

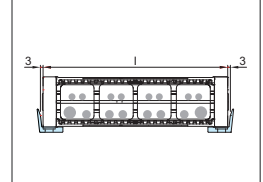

Chain Type	C FEB fix hole(inner)	D Frame	E FEB hole width	F FEB width	G GC hole width	I FEB width
ST 072N	35	50	62	100	62	82
	60	75	87	125	87	107
	85	100	112	150	112	132
	110	125	137	175	137	157
	125	140	152	190	152	172
	135	150	162	200	162	182
	150	165	177	215	177	197
	160	175	187	225	187	207
	175	190	202	240	202	222
	185	200	212	250	212	232
	225	240	252	290	252	272
	235	250	262	300	262	282
285	300	312	312	350	312	332

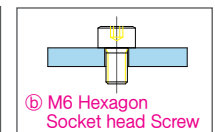
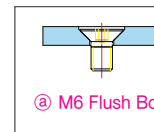

GC Type	H GC length	B GC fixing hole	A GC hole
GC300	300	301	226
GC500	300	501	426

(Dimensions in mm)

» Ordering

ST 072N. 175. R200 / F - 2000L : 10ST

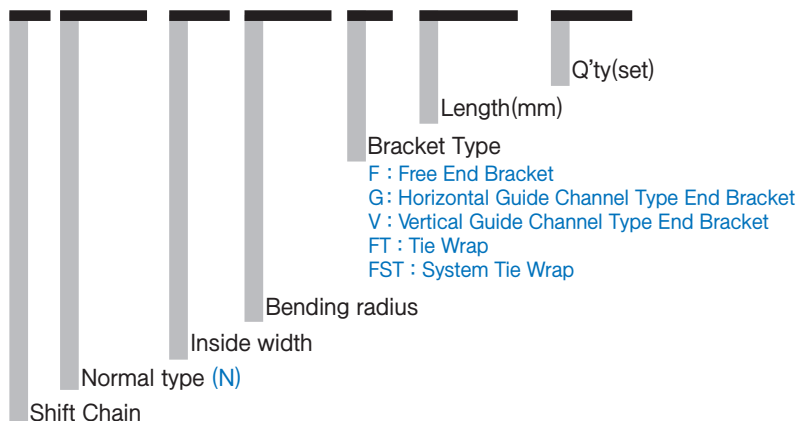

ST095N - Unity Systems

Unity system Application method

Item	Value
Vertical type	Only 1 set of GC,FEB (End bracket) and 1pcs of GC,EC(End cap)
Horizontal type	1set of GC,FEB + 1pcs of GC,EC(End cap) + 1/2LS of GC(Guide channel)

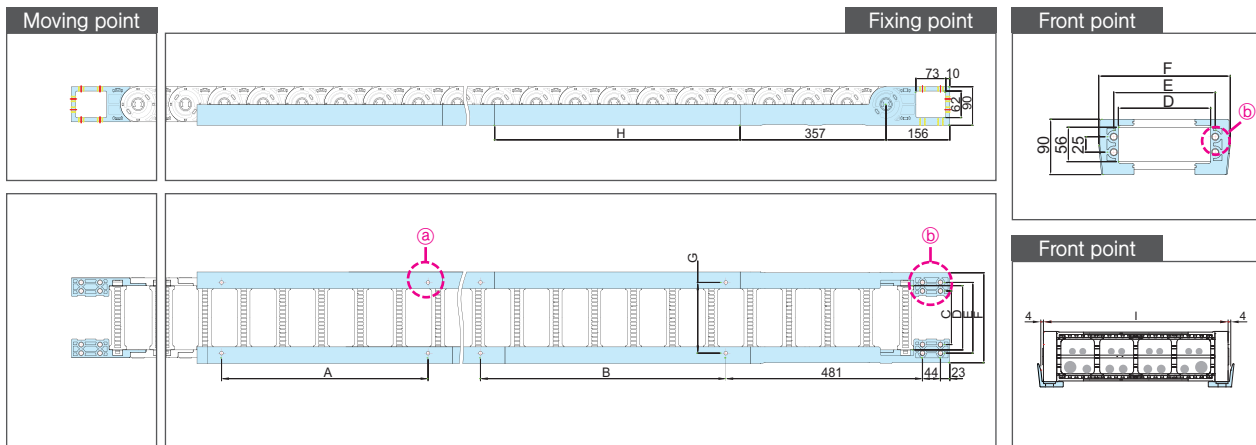
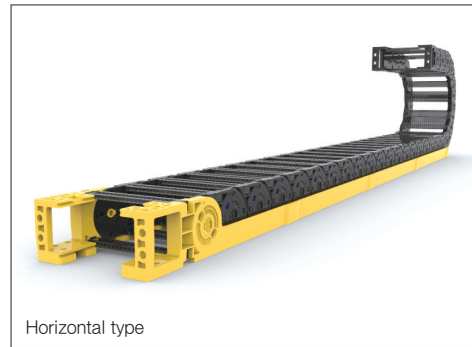
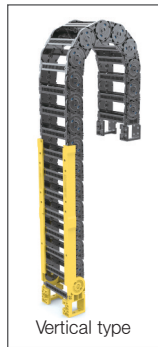

Chain Type	C FEB fix hole(inner)	D Frame	E FEB hole width	F FEB width	G GC hole width	I FEB width
ST 095N	50	75	90	135	90	113
	75	100	115	160	115	138
	100	125	140	185	140	163
	125	150	165	210	165	188
	150	175	190	235	190	213
	165	190	205	250	205	228
	175	200	215	260	215	238
	200	230	245	280	245	268
	215	240	255	290	255	278
	225	250	265	310	265	288
	275	300	315	360	315	338
	325	350	365	410	365	388
	375	400	415	460	415	438

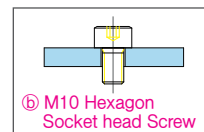
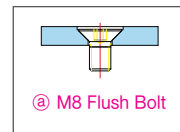

GC Type	H GC length	B GC fixing hole	A GC hole
GC600	600	601	505
GC800	800	801	705

(Dimensions in mm)

Ordering

ST 095N, 200, R230 / F - 2500L : 10ST

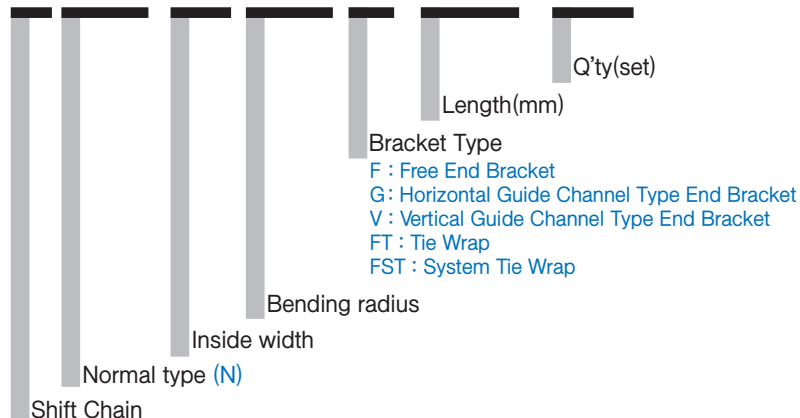

ST120N - Unity Systems

Unity system Application method

Item	Value
Vertical type	Only 1 set of GC,FEB (End bracket) and 1pcs of GC,EC(End cap)
Horizontal type	1set of GC,FEB + 1pcs of GC,EC(End cap) + ½LS of GC(Guide channel)

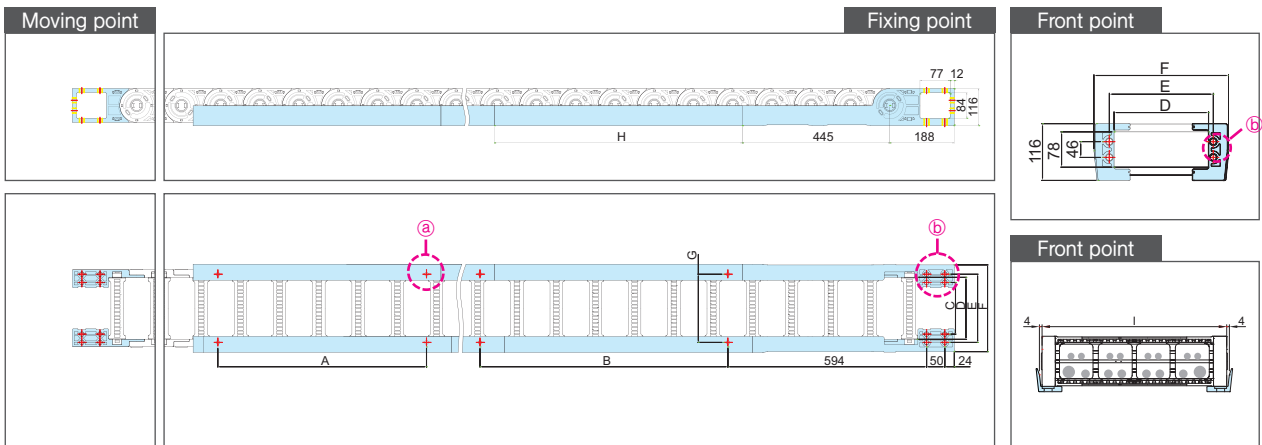
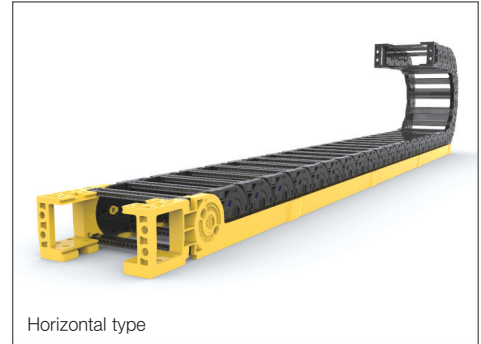
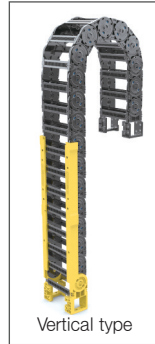

Chain Type	C FEB fix hole(inner)	D Frame	E FEB hole width	F FEB width	G GC hole width	I FEB width
ST 120N	47	75	104	139	94	117
	72	100	129	164	119	142
	87	115	144	179	134	157
	97	125	154	189	144	167
	122	150	179	214	169	192
	147	175	204	239	194	217
	172	200	229	264	219	242
	212	240	269	304	259	282
	222	250	279	314	269	292
	262	290	319	354	309	332
	272	300	329	364	319	342
	322	350	379	414	369	392
	372	400	429	464	419	442
	422	450	479	514	469	492
	472	500	529	564	519	542
522	550	579	614	569	592	
572	600	629	664	619	642	

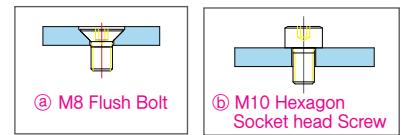

GC Type	H GC length	B GC fixing hole	A GC hole
GC600	600	601	505
GC800	800	801	705

(Dimensions in mm)

Ordering

ST 120N, 400, R300 / F - 3000L : 10ST

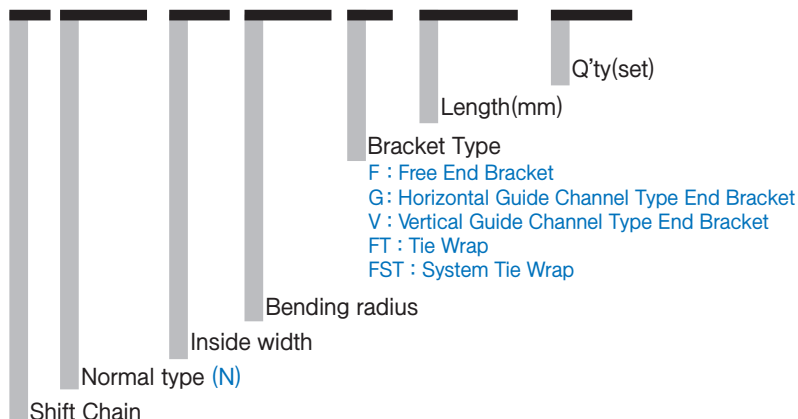

ST044E- Unity Systems

Unity system Application method

Item	Value
Vertical type	Only 1 set of GC,FEB (End bracket) and 1pcs of GC,EC(End cap)
Horizontal type	1set of GC,FEB + 1pcs of GC,EC(End cap) + ½LS of GC(Guide channel)

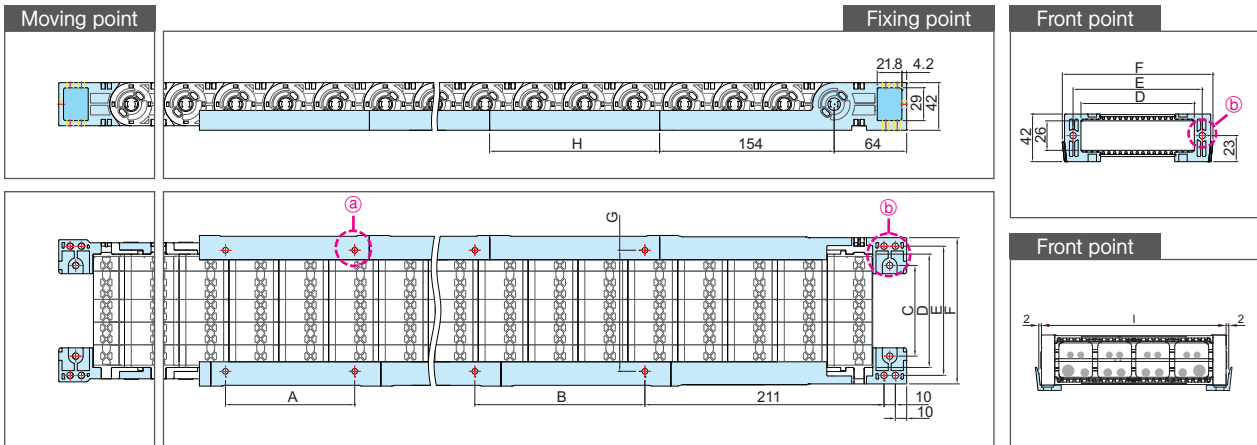
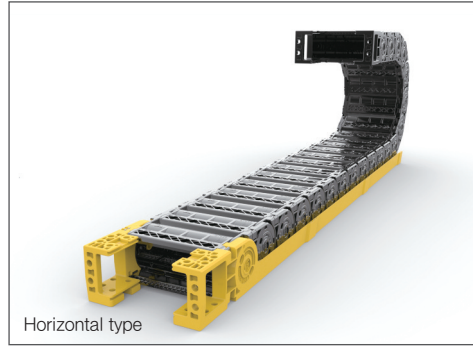
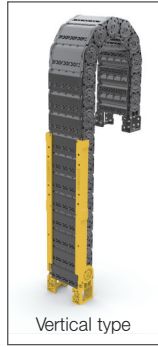

Chain Type	C FEB fix hole(inner)	D Frame	E FEB hole width	F FEB width	G GC hole width	I FEB width
ST 044E	15	35	49	68	41.8	56
	35	55	69	88	61.8	76
	55	75	89	108	81.8	96
	80	100	114	133	106.8	121

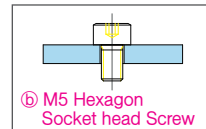
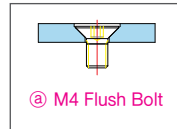

GC Type	H GC length	B GC fixing hole	A GC hole
GC150	150	151	114
GC250	250	251	214

(Dimensions in mm)

Ordering

ST 044E, 100, R120 / F - 1500L : 10ST

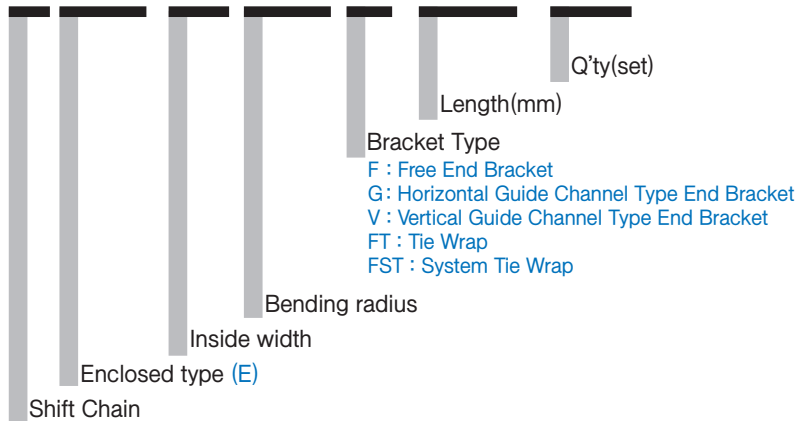

ST055E- Unity Systems

» Unity system Application method

Item	Value
Vertical type	Only 1 set of GC,FEB (End bracket) and 1pcs of GC,EC(End cap)
Horizontal type	1set of GC,FEB + 1pcs of GC,EC(End cap) + ½LS of GC(Guide channel)

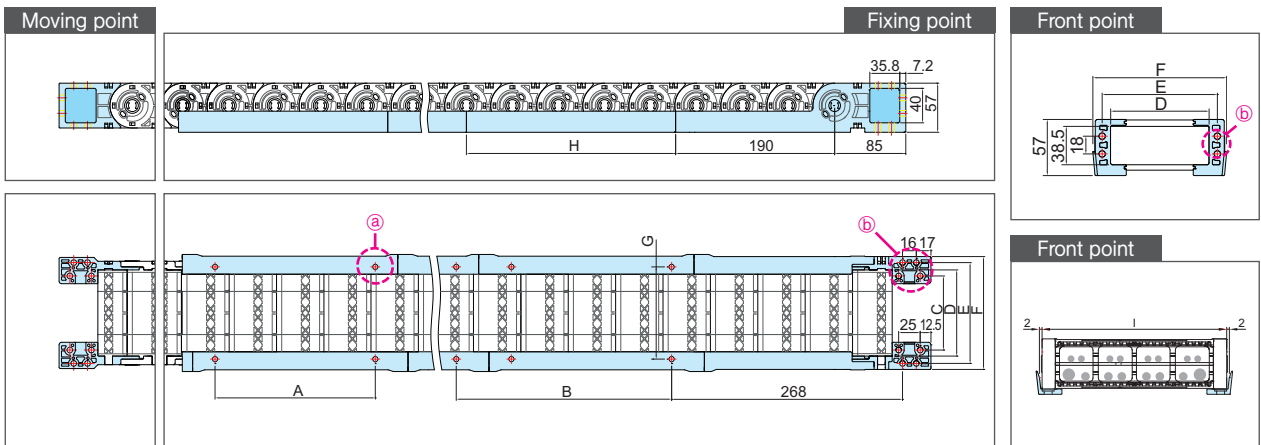
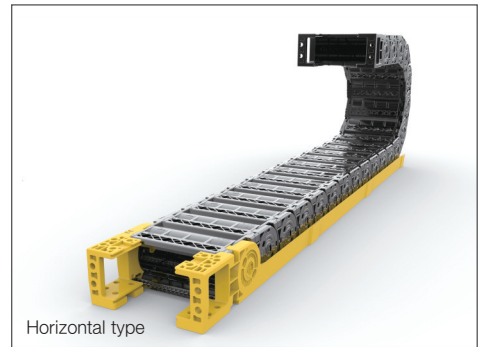
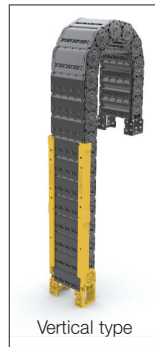

Chain Type	C FEB fix hole(inner)	D Frame	E FEB hole width	F FEB width	G GC hole width	I FEB width
ST 055E	36	50	67	67	57	71
	61	75	92	92	82	96
	86	100	117	117	107	121
	111	125	142	142	132	146
	136	150	167	167	157	171

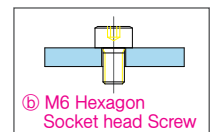
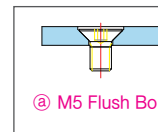

GC Type	H GC length	B GC fixing hole	A GC hole
GC250	250	251	186
GC400	400	401	336

(Dimensions in mm)

» Ordering

ST 055E. 150. R150 / F - 1800L : 10ST

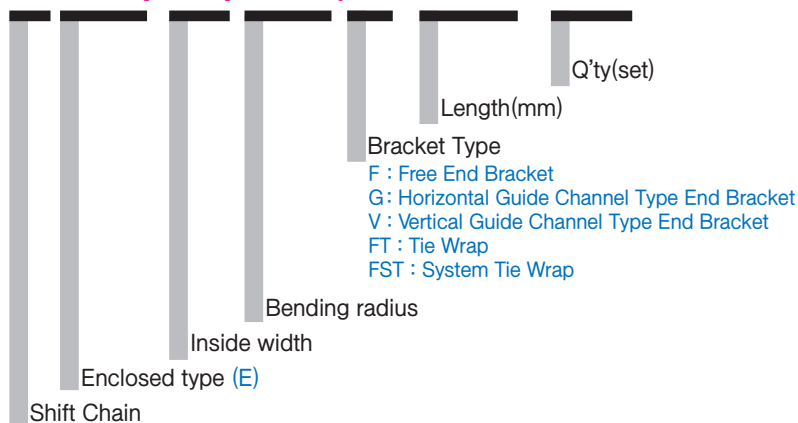

ST072E- Unity Systems

Unity system Application method

Item	Value
Vertical type	Only 1 set of GC,FEB (End bracket) and 1pcs of GC,EC(End cap)
Horizontal type	1set of GC,FEB + 1pcs of GC,EC(End cap) + ½LS of GC(Guide channel)

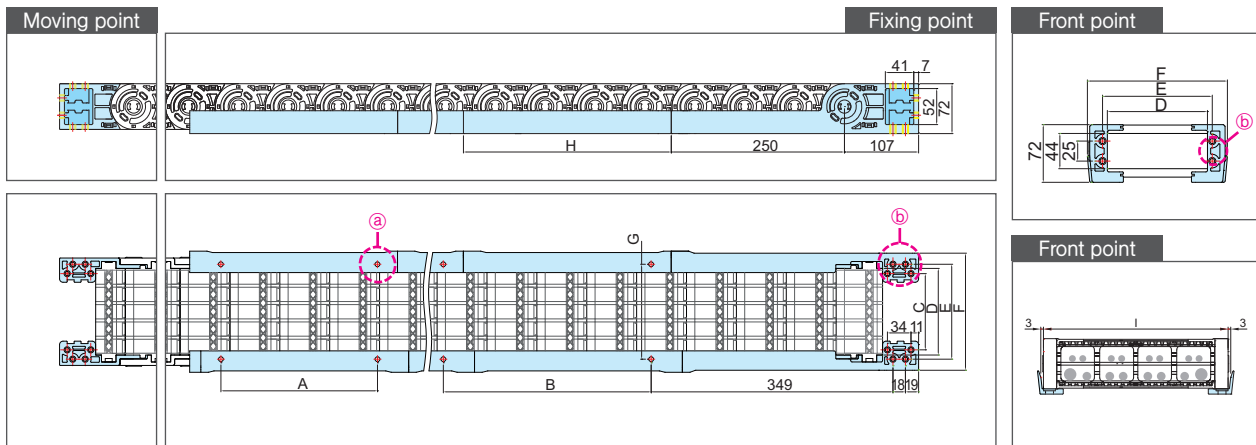
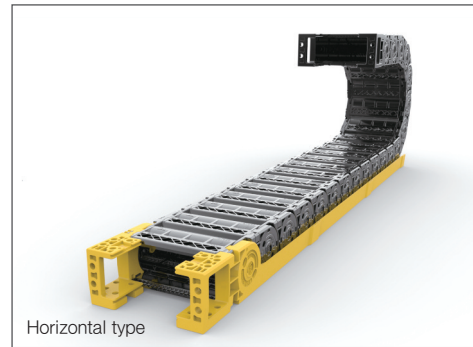
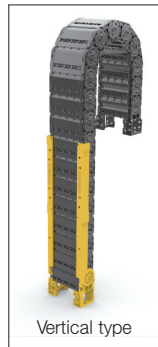

Chain Type	C FEB fix hole(inner)	D Frame	E FEB hole width	F FEB width	G GC hole width	I FEB width
ST 072E	35	50	62	100	62	82
	60	75	87	125	87	107
	85	100	112	150	112	132
	110	125	137	175	137	157
	135	150	162	200	162	182

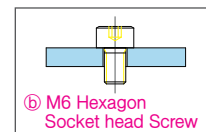
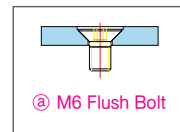

GC Type	H GC length	B GC fixing hole	A GC hole
GC300	300	301	226
GC500	500	501	426

(Dimensions in mm)

Ordering

ST 072E, 150, R200 / F - 3000L : 10ST

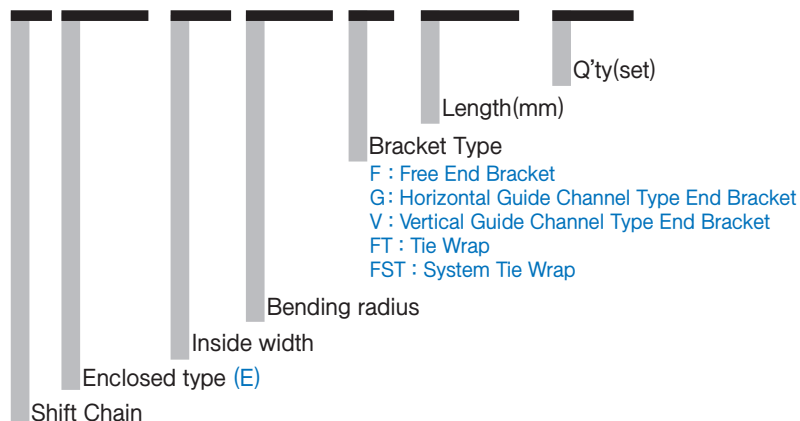

ST095E- Unity Systems

» Unity system Application method

Item	Value
Vertical type	Only 1 set of GC,FEB (End bracket) and 1pcs of GC,EC(End cap)
Horizontal type	1set of GC,FEB + 1pcs of GC,EC(End cap) + ½LS of GC(Guide channel)

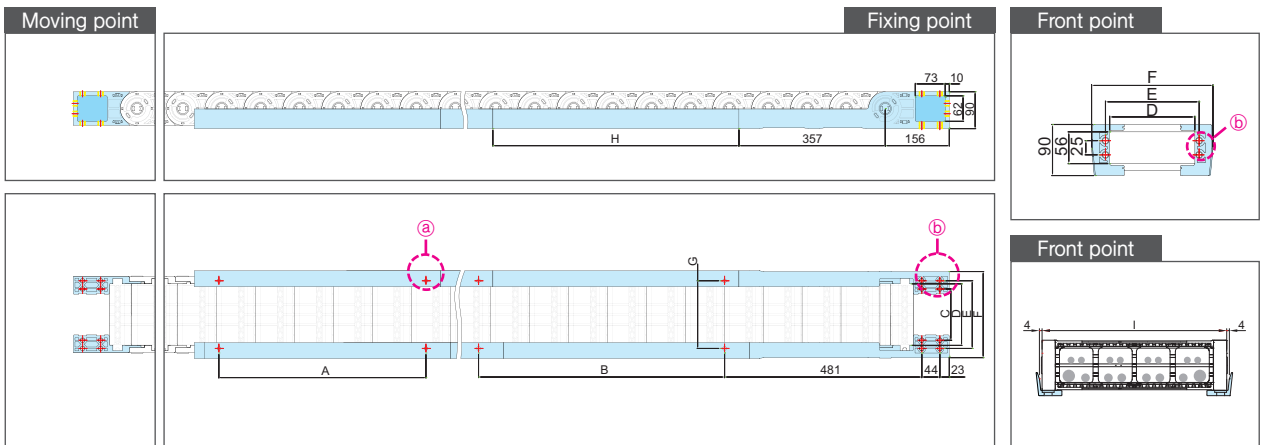
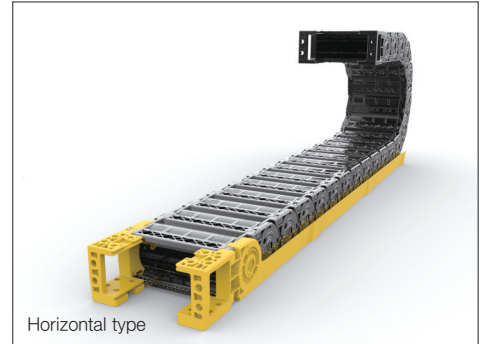
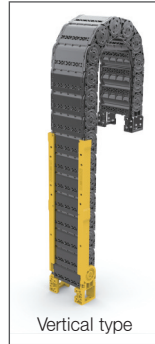

Chain Type	C FEB fix hole(inner)	D Frame	E FEB hole width	F FEB width	G GC hole width	I FEB width
ST 095E	75	100	115	160	115	138
	100	125	140	185	140	163
	125	150	165	210	165	188
	150	175	190	235	190	213
	175	200	215	260	215	238

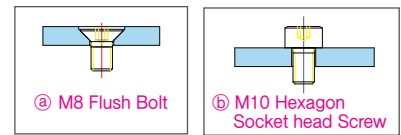

GC Type	H GC length	B GC fixing hole	A GC hole
GC600	600	601	505
GC800	800	801	705

(Dimensions in mm)

» Ordering

ST 095E, 200, R200 / F - 3000L : 10ST

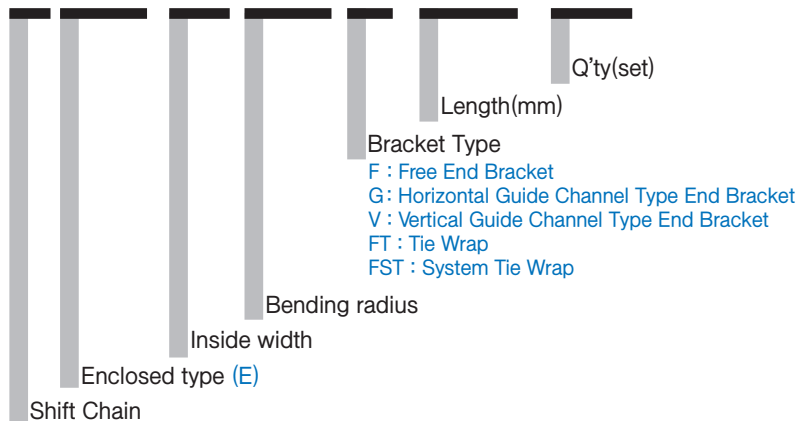

ST120E- Unity Systems

Unity system Application method

Item	Value
Vertical type	Only 1 set of GC,FEB (End bracket) and 1pcs of GC,EC(End cap)
Horizontal type	1set of GC,FEB + 1pcs of GC,EC(End cap) + ½LS of GC(Guide channel)

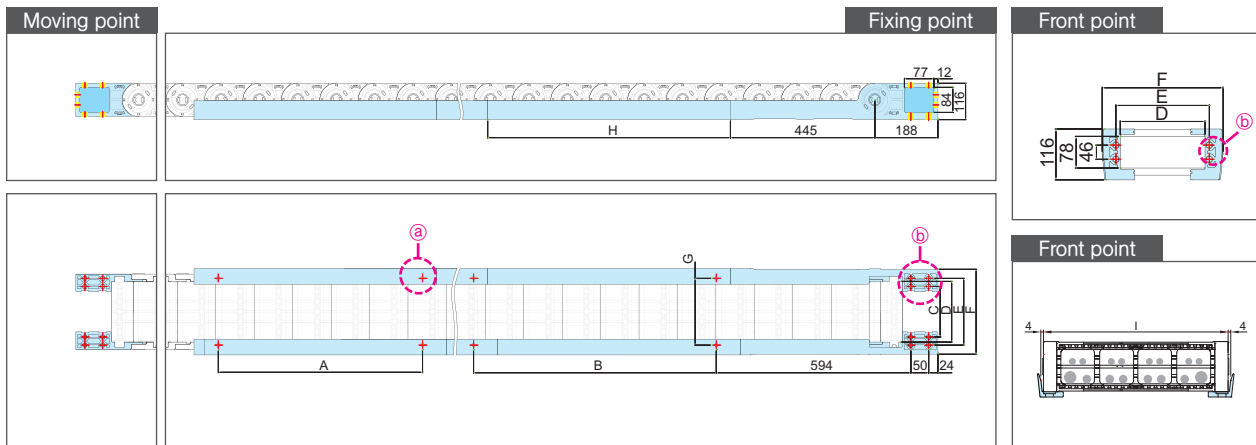
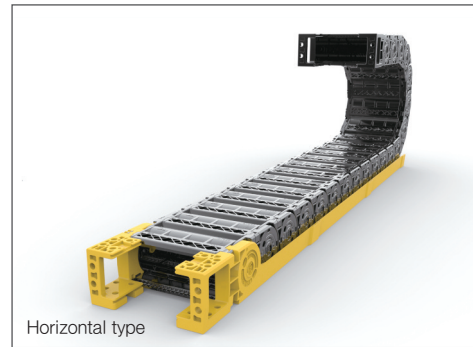
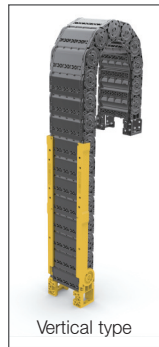

Chain Type	C FEB fix hole(inner)	D Frame	E FEB hole width	F FEB width	G GC hole width	I FEB width
ST 120E	122	150	179	214	169	192
	172	200	229	264	219	242
	222	250	279	314	269	292
	272	300	329	364	319	342

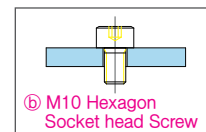
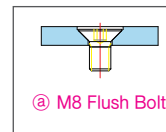

GC Type	H GC length	B GC fixing hole	A GC hole
GC600	600	601	505
GC800	800	801	705

(Dimensions in mm)

Ordering

ST 120E, 200, R200 / F - 3000L : 10ST

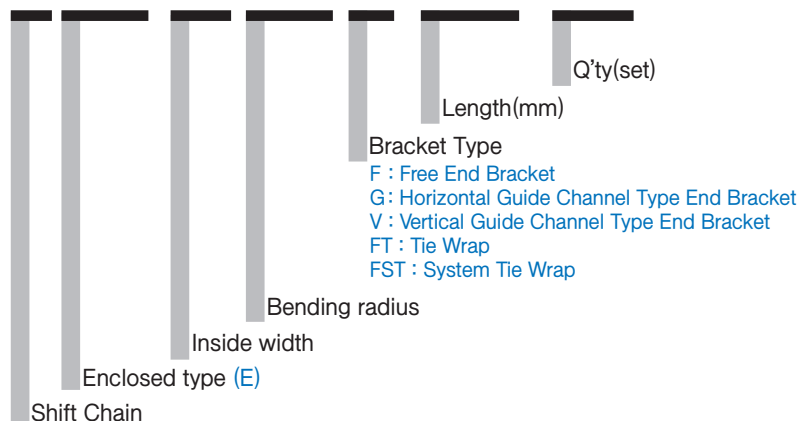

nsb020CR- Unity Systems

Unity system Application method

Item	Value
Vertical type	Only 1 set of GC,FEB (End bracket) and 1pcs of GC,EC(End cap)
Horizontal type	1set of GC,FEB + 1pcs of GC,EC(End cap) + ½LS of GC(Guide channel)

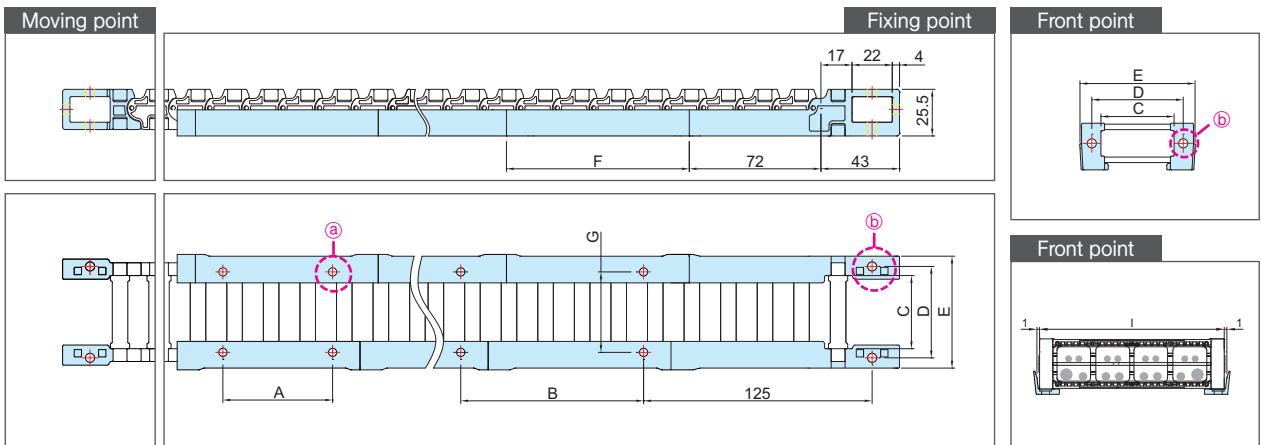
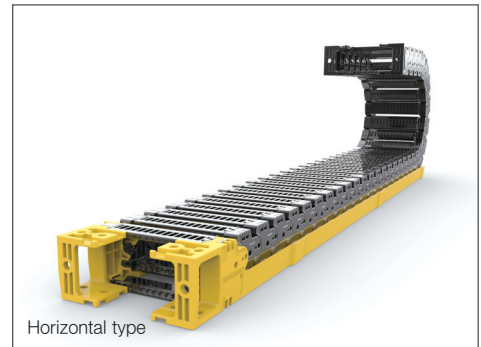
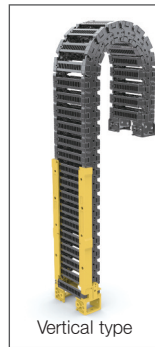

Chain Type	C FEB fix hole(inner)	D Frame	E FEB hole width	G GC hole width	I FEB width
nsb 020CR	20	30	44	24	34
	40	50	64	44	54

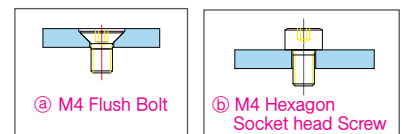

GC Type	F FEB width	B GC fixing hole	A GC hole
GC100	100	101	60
GC200	200	201	160

(Dimensions in mm)

Ordering

nsb 020CR, 20, R48 / F - 600L : 10ST

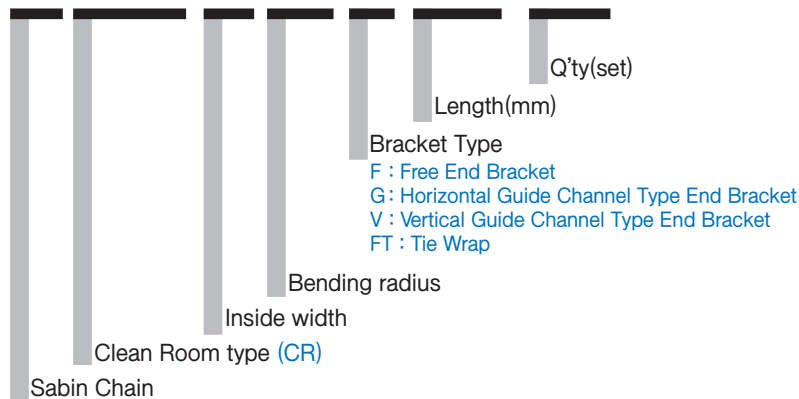

nsb022CR- Unity Systems

Unity system Application method

Item	Value
Vertical type	Only 1 set of GC,FEB (End bracket) and 1pcs of GC,EC(End cap)
Horizontal type	1set of GC,FEB + 1pcs of GC,EC(End cap) + ½LS of GC(Guide channel)

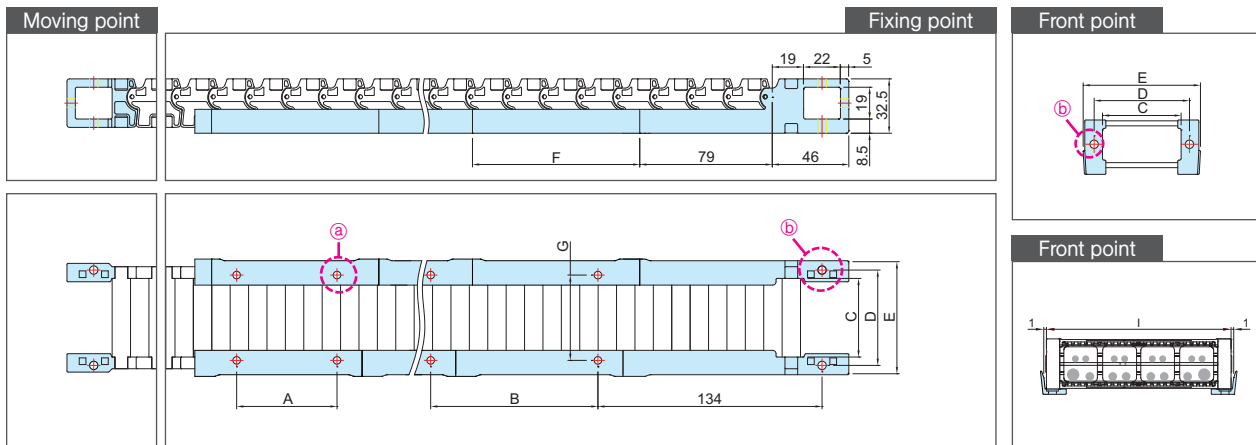
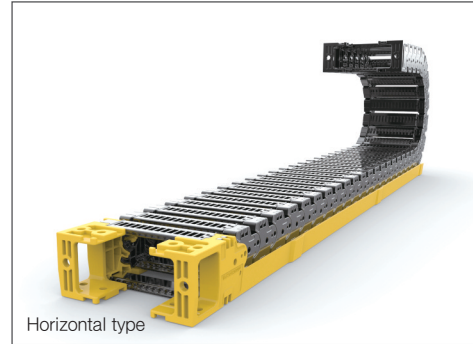
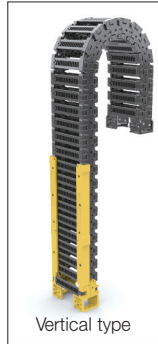

Chain Type	C FEB fix hole(inner)	D Frame	E FEB hole width	G GC hole width	I FEB width
nsb 022CR	16	26	40	20	30
	27	37	51	31	41
	37	47	61	41	51
	47	57	71	51	61
	67	77	91	71	81
	77	87	101	81	91

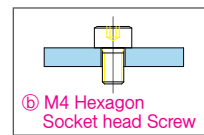
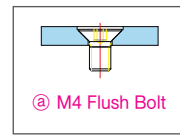

GC Type	F FEB width	B GC fixing hole	A GC hole
GC100	100	101	60
GC200	200	201	160

(Dimensions in mm)

Ordering

nsb 022CR. 47. R45 / F - 846L : 10ST

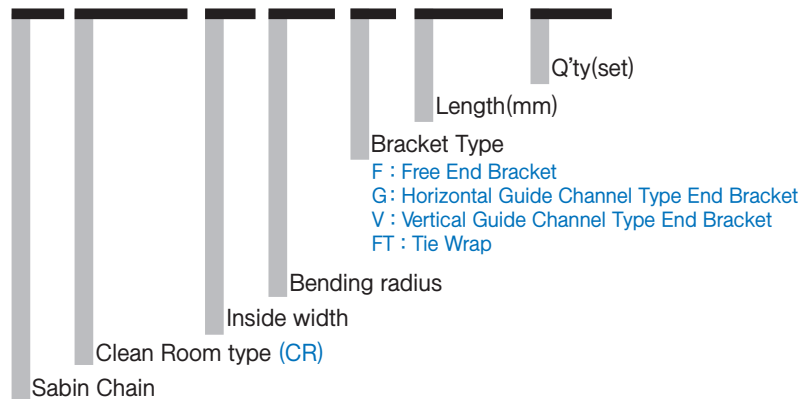

nsb028CR- Unity Systems

Unity system Application method

Item	Value
Vertical type	Only 1 set of GC,FEB (End bracket) and 1pcs of GC,EC(End cap)
Horizontal type	1set of GC,FEB + 1pcs of GC,EC(End cap) + ½LS of GC(Guide channel)

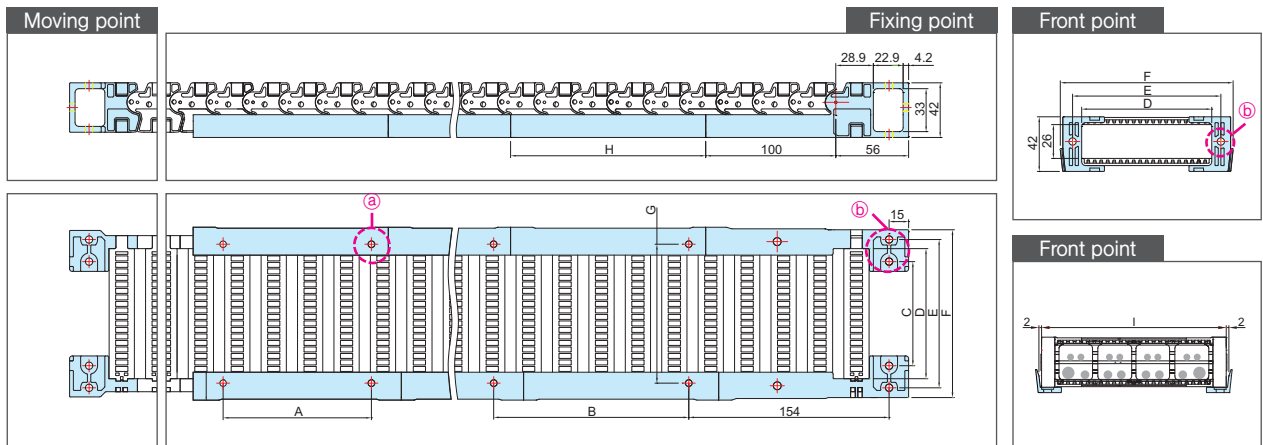
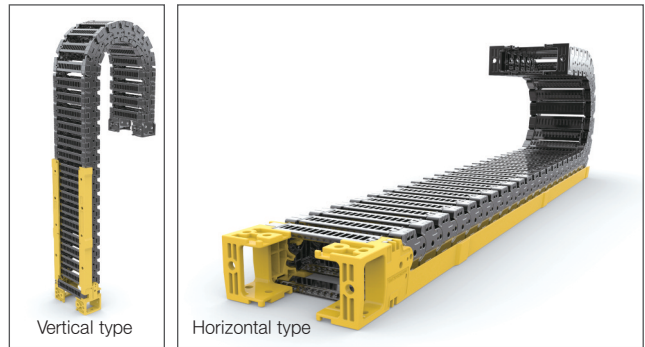

Chain Type	C FEB fix hole(inner)	D Frame	E FEB hole width	F FEB width	G GC hole width	I FEB width
nsb 028CR	15	35	49	68	41.8	55
	30	50	64	83	56.8	70
	35	55	69	88	61.8	75
	55	75	89	108	81.8	95
	80	100	114	133	106.8	120
	105	125	139	158	131.8	145
	130	150	164	183	156.8	170
155	175	189	208	181.8	195	
180	200	214	233	206.8	220	

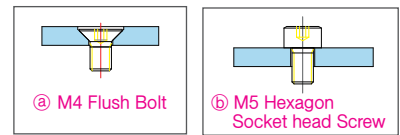

GC Type	H GC length	B GC fixing hole	A GC hole
GC150	150	151	114
GC250	250	251	214

(Dimensions in mm)

Ordering

nsb 028CR, 75, R70 / F - 1000L : 10ST

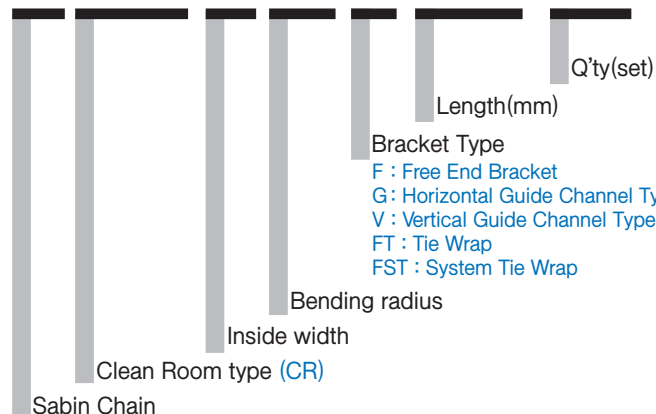

nsb035CR- Unity Systems

Unity system Application method

Item	Value
Vertical type	Only 1 set of GC,FEB (End bracket) and 1pcs of GC,EC(End cap)
Horizontal type	1set of GC,FEB + 1pcs of GC,EC(End cap) + ½LS of GC(Guide channel)

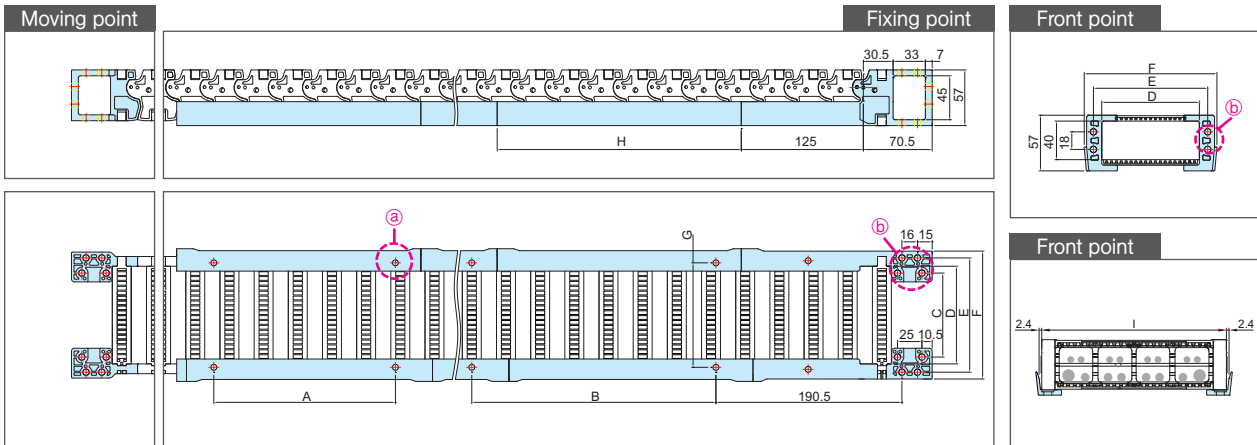
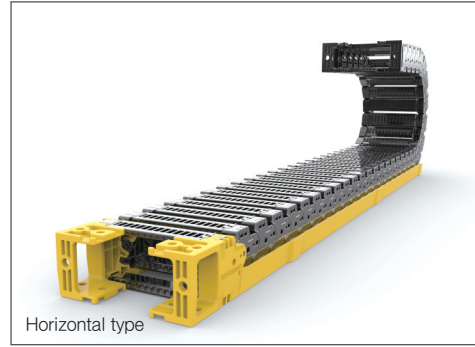
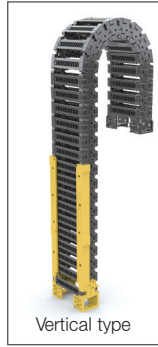

Chain Type	C FEB fix hole(inner)	D Frame	E FEB hole width	F FEB width	G GC hole width	I FEB width
nsb 035CR	21	35	52	71	42	55
	36	50	67	86	57	70
	41	55	72	91	62	75
	61	75	92	111	82	95
	86	100	117	136	107	120
	111	125	142	161	132	145
	136	150	167	186	157	170
	161	175	192	211	182	195
186	200	217	236	207	220	

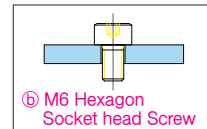
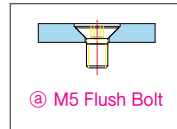

GC Type	H GC length	B GC fixing hole	A GC hole
GC250	250	251	186
GC400	400	401	336

(Dimensions in mm)

Ordering

nsb 035CR. 100. R75 / F - 1200L : 10ST

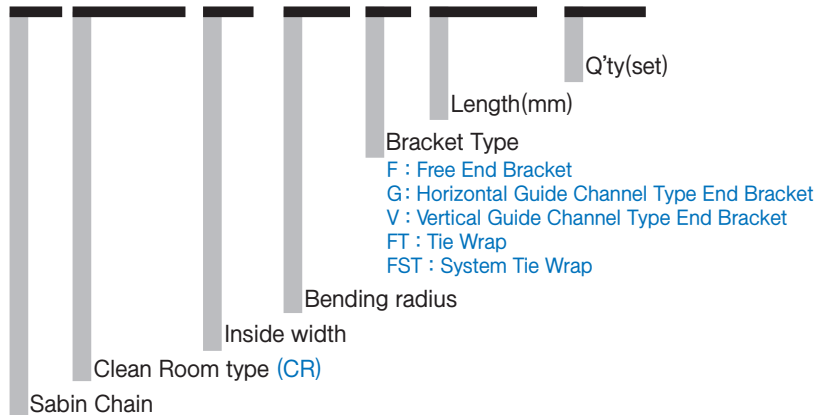

nsb045CR- Unity Systems

» Unity system Application method

Item	Value
Vertical type	Only 1 set of GC,FEB (End bracket) and 1pcs of GC,EC(End cap)
Horizontal type	1set of GC,FEB + 1pcs of GC,EC(End cap) + ½LS of GC(Guide channel)

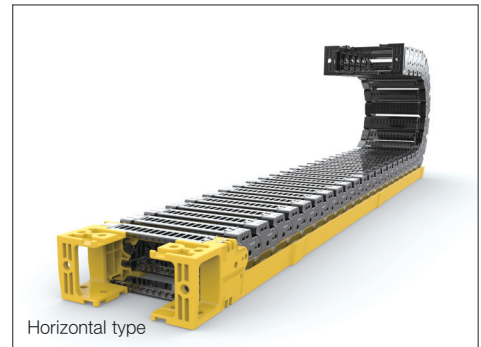
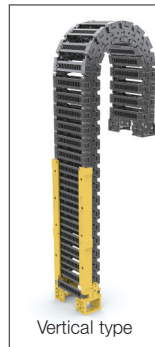

Moving point

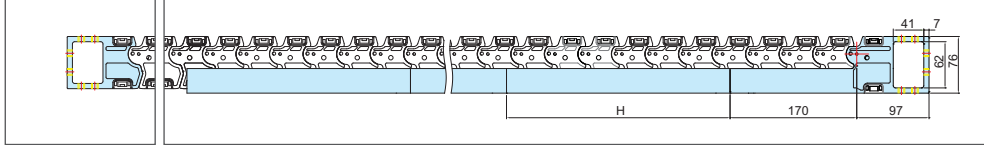

Fixing point

Front point

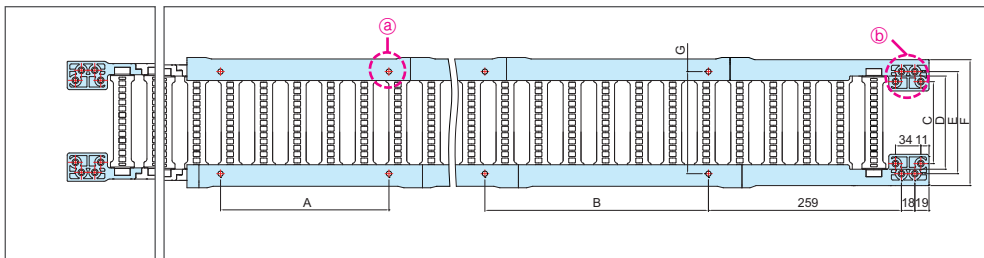
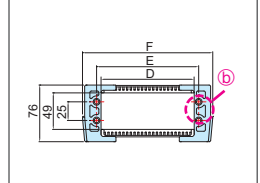

Front point

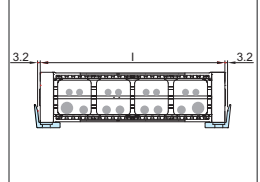

Chain Type	C FEB fix hole(inner)	D Frame	E FEB hole width	F FEB width	G GC hole width	I FEB width
nsb 045CR	35	50	62	100	62	80
	60	75	87	125	87	105
	85	100	112	150	112	130
	110	125	137	175	137	155
	125	140	152	190	152	170
	135	150	162	200	162	180
	150	165	177	215	177	195
	160	175	187	225	187	205
	175	190	202	240	202	220
	185	200	212	250	212	230
	225	240	252	290	252	270
	235	250	262	300	262	280
285	300	312	350	312	330	

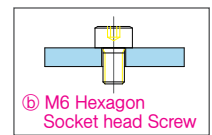
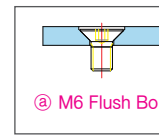

GC Type	H GC length	B GC fixing hole	A GC hole
GC300	300	301	226
GC500	500	501	426

(Dimensions in mm)

» Ordering

nsb 045CR, 100, R75 / F - 2000L : 10ST

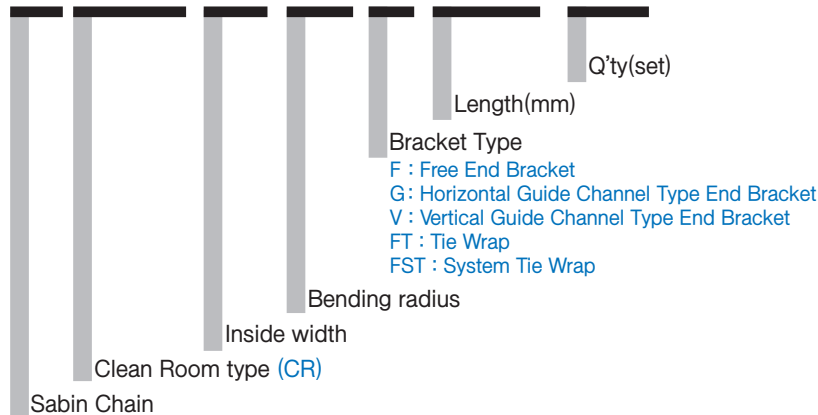

nsb060CR-Unity Systems

>> Unity system Application method

Item	Value
Vertical type	Only 1 set of GC,FEB (End bracket) and 1pcs of GC,EC(End cap)
Horizontal type	1set of GC,FEB + 1pcs of GC,EC(End cap) + ½LS of GC(Guide channel)

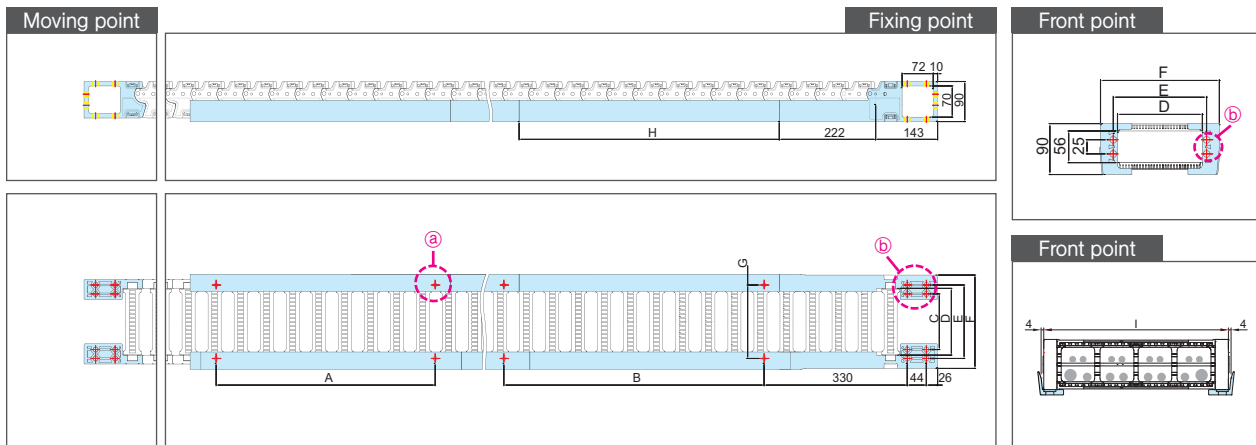
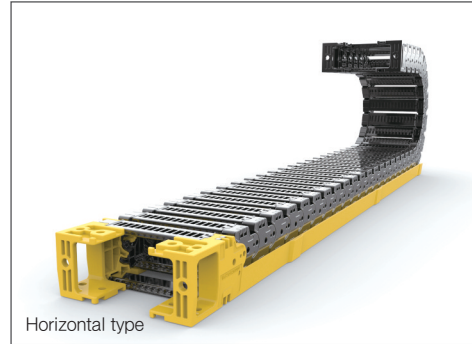
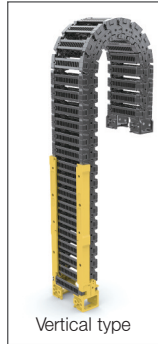

Chain Type	C FEB fix hole(inner)	D Frame	E FEB hole width	F FEB width	G GC hole width	I FEB width
nsb 060CR	50	75	90	139	94	115
	75	100	115	164	119	140
	100	125	140	189	144	165
	125	150	165	214	169	190
	150	175	190	239	194	215
	165	190	205	254	209	230
	175	200	215	264	219	240
	205	230	245	294	249	270
	215	240	255	304	259	280
	225	250	265	314	269	290
	275	300	315	364	319	340
	325	350	365	414	369	390
	375	400	415	464	419	440

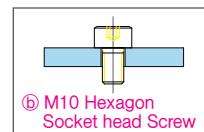
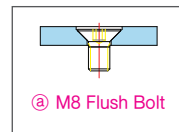

GC Type	H GC length	B GC fixing hole	A GC hole
GC600	600	601	505
GC800	800	801	705

(Dimensions in mm)

>> Ordering

nsb 060CR. 150. R140 / F - 2500L : 10ST

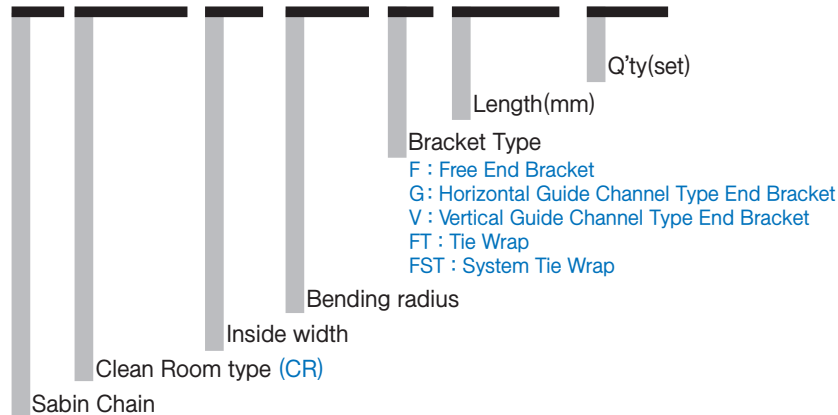

nsb075CR- Unity Systems

Unity system Application method

Item	Value
Vertical type	Only 1 set of GC,FEB (End bracket) and 1pcs of GC,EC(End cap)
Horizontal type	1set of GC,FEB + 1pcs of GC,EC(End cap) + ½LS of GC(Guide channel)

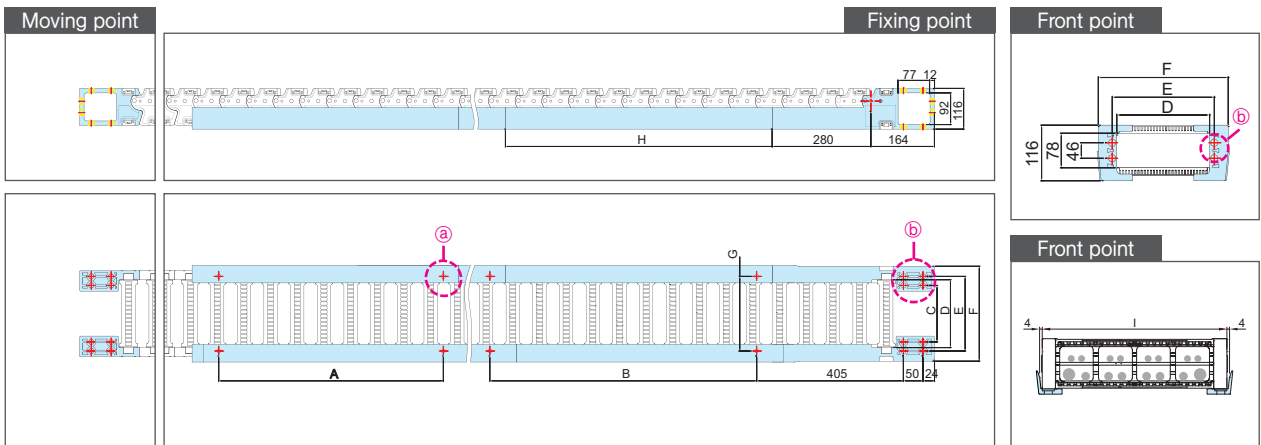
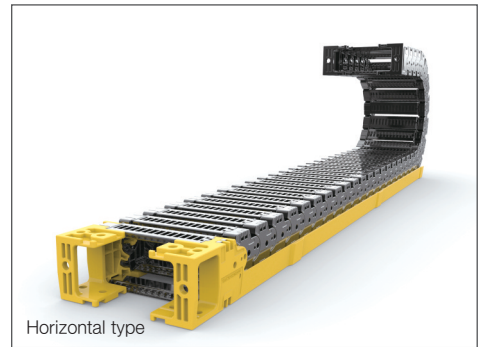
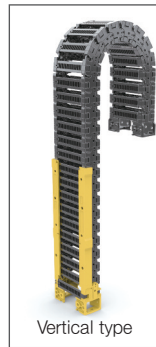

Chain Type	C FEB fix hole(inner)	D Frame	E FEB hole width	F FEB width	G GC hole width	I FEB width
nsb 075CR	47	75	104	139	94	115
	72	100	129	164	119	140
	87	115	144	179	134	155
	97	125	154	189	144	165
	122	150	179	214	169	190
	147	175	204	239	194	215
	172	200	229	264	219	240
	212	240	269	304	259	280
	222	250	279	314	269	290
	262	290	319	354	309	330
	272	300	329	364	319	340
	322	350	379	414	369	390
	372	400	429	464	419	440
	422	450	479	514	469	490
	472	500	529	564	519	540
522	550	579	614	569	590	
572	600	629	664	619	640	

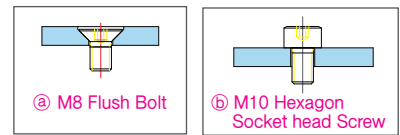

GC Type	H GC length	B GC fixing hole	A GC hole
GC600	600	601	505
GC800	800	801	705

(Dimensions in mm)

Ordering

nsb 075CR, 300, R200 / F - 3000L : 10ST

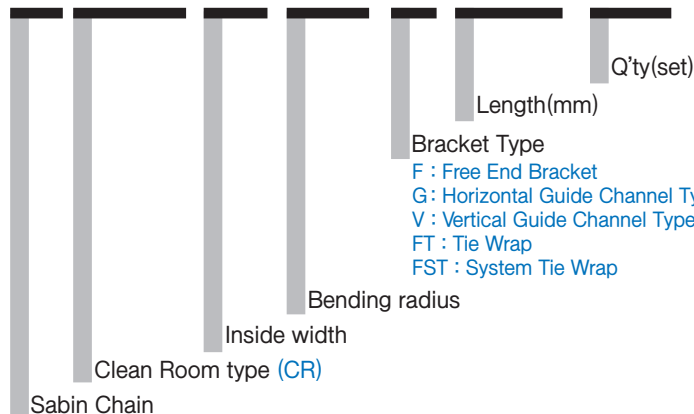

nsb028N- Unity Systems

Unity system Application method

Item	Value
Vertical type	Only 1 set of GC,FEB (End bracket) and 1pcs of GC,EC(End cap)
Horizontal type	1set of GC,FEB + 1pcs of GC,EC(End cap) + ½LS of GC(Guide channel)

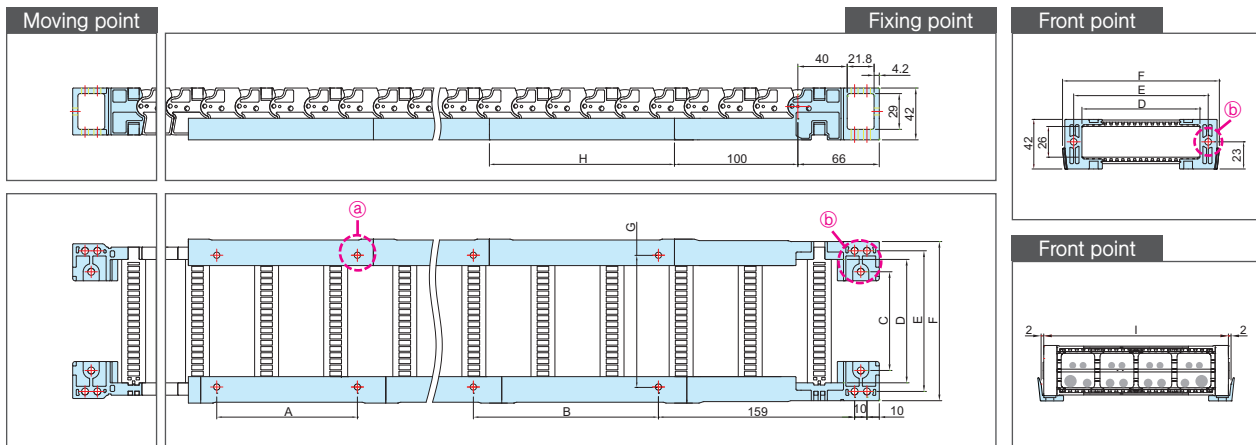
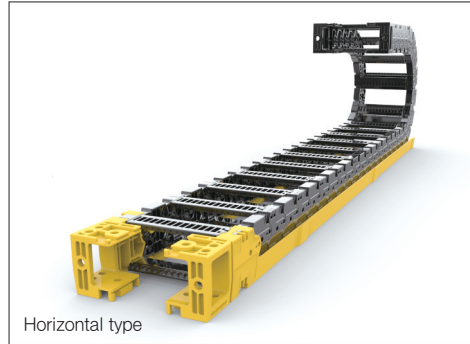
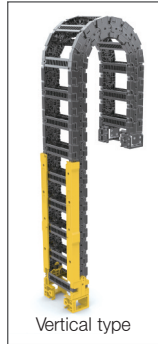

Chain Type	C FEB fix hole(inner)	D Frame	E FEB hole width	F FEB width	G GC hole width	I FEB width
nsb 028N	15	35	49	68	41.8	55
	30	50	64	83	56.8	70
	35	55	69	88	61.8	75
	55	75	89	108	81.8	95
	80	100	114	133	106.8	120
	105	125	139	158	131.8	145
	130	150	164	183	156.8	170
	155	175	189	208	181.8	195
180	200	214	233	206.8	220	

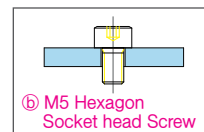
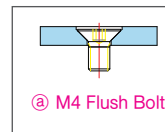

GC Type	H GC length	B GC fixing hole	A GC hole
GC150	150	151	114
GC250	250	251	214

(Dimensions in mm)

Ordering

nsb 028N, 50, R66 / F - 1000L : 10ST

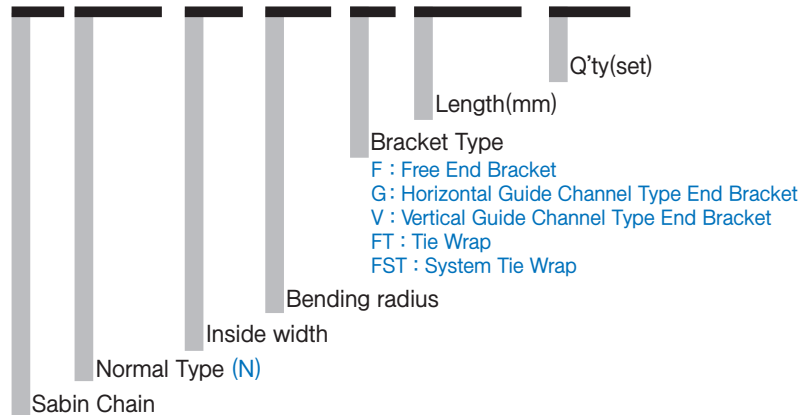

nsb035N- Unity Systems

» Unity system Application method

Item	Value
Vertical type	Only 1 set of GC,FEB (End bracket) and 1pcs of GC,EC(End cap)
Horizontal type	1set of GC,FEB + 1pcs of GC,EC(End cap) + ½LS of GC(Guide channel)

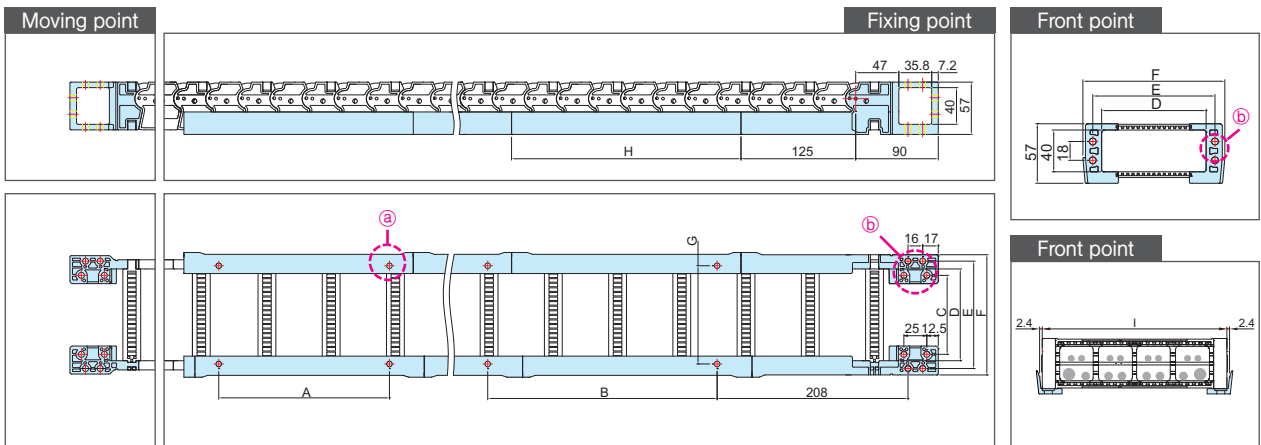
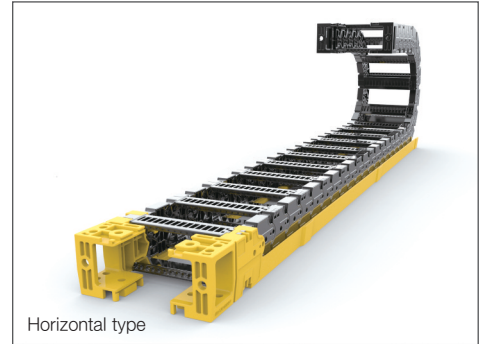
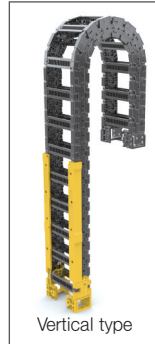

Chain Type	C FEB fix hole(inner)	D Frame	E FEB hole width	F FEB width	G GC hole width	I FEB width
nsb 035N	21	35	52	71	42	55
	36	50	67	86	57	70
	41	55	72	91	62	75
	61	75	92	111	82	95
	86	100	117	136	107	120
	111	125	142	161	132	145
	136	150	167	186	157	170
	161	175	192	211	182	195
186	200	217	236	207	220	

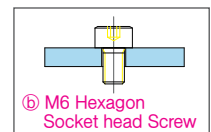
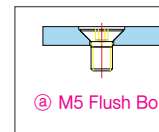

GC Type	H GC length	B GC fixing hole	A GC hole
GC250	250	251	186
GC400	400	401	336

(Dimensions in mm)

» Ordering

nsb 035N. 75. R90 / F - 1000L : 10ST

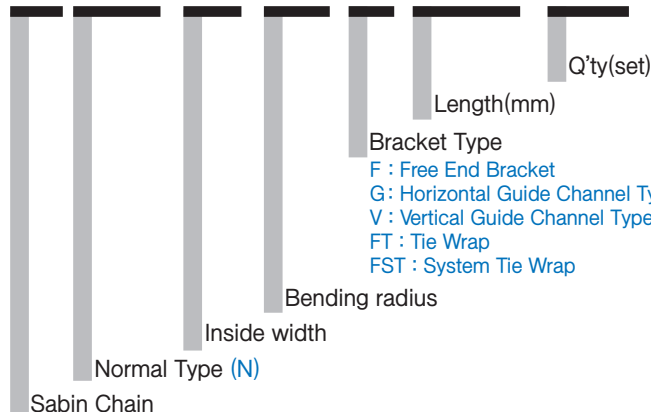

nsb045N- Unity Systems

>> Unity system Application method

Item	Value
Vertical type	Only 1 set of GC,FEB (End bracket) and 1pcs of GC,EC(End cap)
Horizontal type	1set of GC,FEB + 1pcs of GC,EC(End cap) + ½LS of GC(Guide channel)

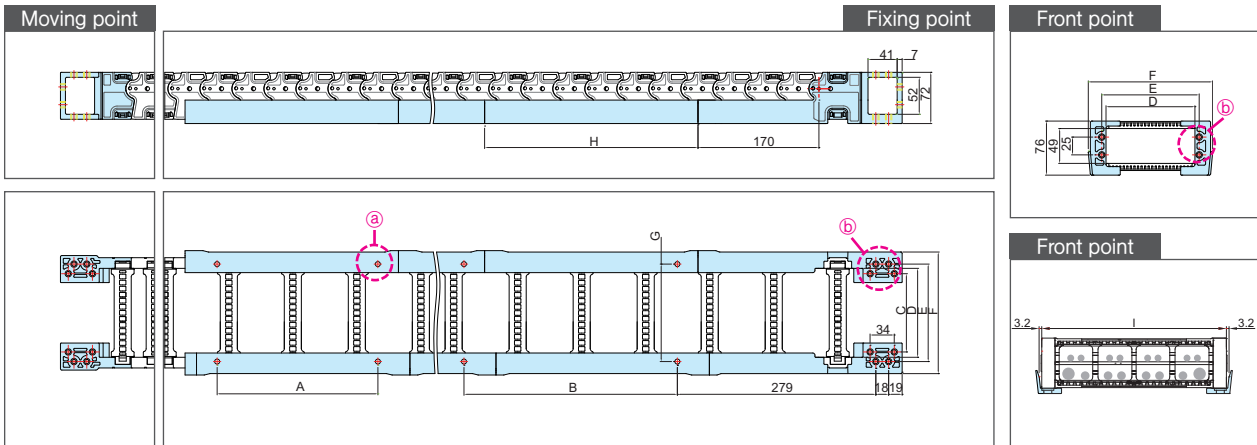
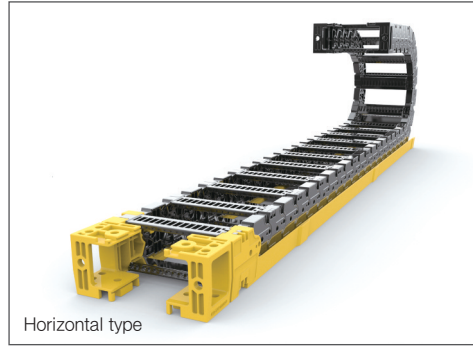
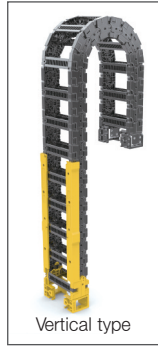

Chain Type	C FEB fix hole(inner)	D Frame	E FEB hole width	F FEB width	G GC hole width	I FEB width
nsb 045N	35	50	62	100	62	80
	60	75	87	125	87	105
	85	100	112	150	112	130
	110	125	137	175	137	155
	125	140	152	190	152	170
	135	150	162	200	162	180
	150	165	177	215	177	195
	160	175	187	225	187	205
	175	190	202	240	202	220
	185	200	212	250	212	230
	225	240	252	290	252	270
	235	250	262	300	262	280
285	300	312	350	312	330	

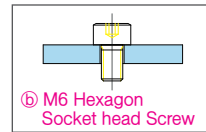
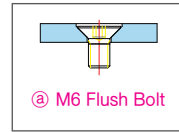

GC Type	H GC length	B GC fixing hole	A GC hole
GC250	250	251	186
GC400	400	401	336

(Dimensions in mm)

>> Ordering

nsb 045N, 125, R165 / F - 2000L : 10ST

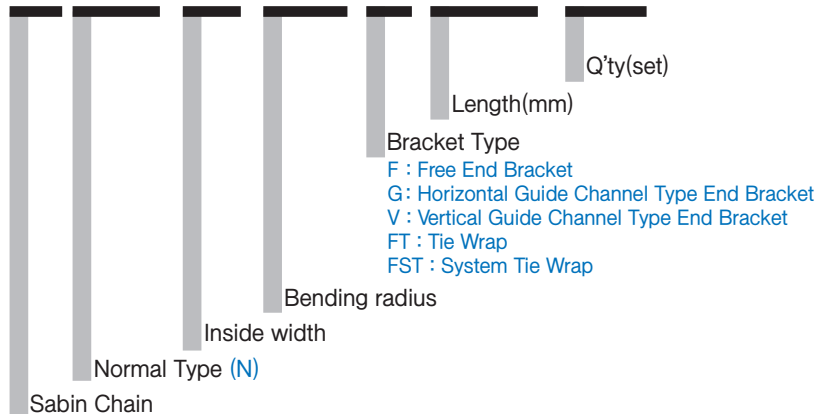

nsb060N- Unity Systems

» Unity system Application method

Item	Value
Vertical type	Only 1 set of GC,FEB (End bracket) and 1pcs of GC,EC(End cap)
Horizontal type	1set of GC,FEB + 1pcs of GC,EC(End cap) + ½LS of GC(Guide channel)

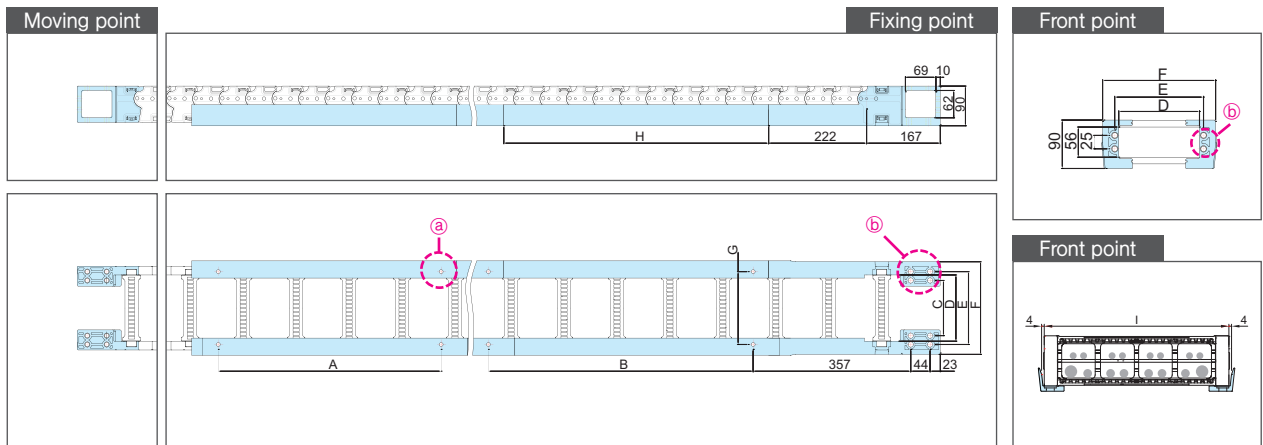
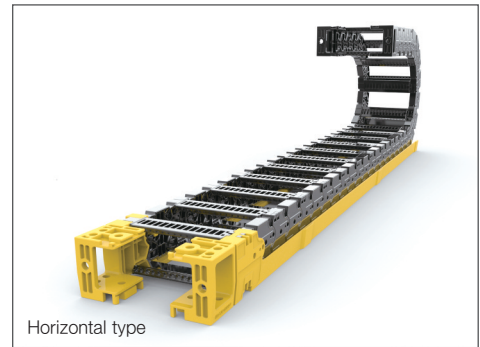
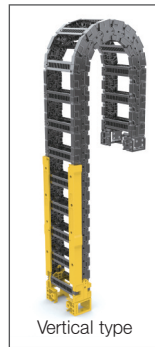

Chain Type	C FEB fix hole(inner)	D Frame	E FEB hole width	F FEB width	G GC hole width	I FEB width
nsb 060N	50	75	90	139	94	115
	75	100	115	164	119	140
	100	125	140	189	144	165
	125	150	165	214	169	190
	150	175	190	239	194	215
	165	190	205	254	209	230
	175	200	215	264	219	240
	205	230	245	294	249	270
	215	240	255	304	259	280
	225	250	265	314	269	290
	275	300	315	364	319	340
	325	350	365	414	369	390
	375	400	415	464	419	440

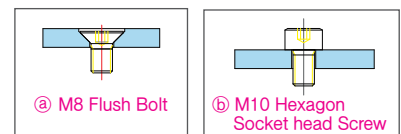

GC Type	H GC length	B GC fixing hole	A GC hole
GC600	600	601	505
GC800	800	801	705

(Dimensions in mm)

» Ordering

nsb 060N, 150, R180 / F - 2500L : 10ST

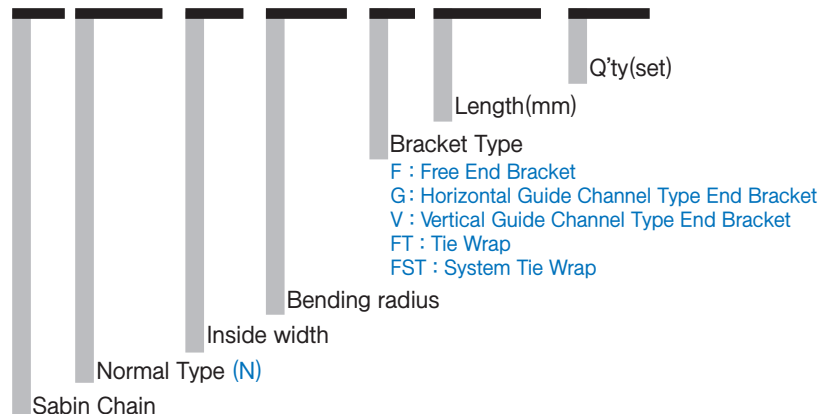

nsb075N- Unity Systems

Unity system Application method

Item	Value
Vertical type	Only 1 set of GC,FEB (End bracket) and 1pcs of GC,EC(End cap)
Horizontal type	1set of GC,FEB + 1pcs of GC,EC(End cap) + ½LS of GC(Guide channel)

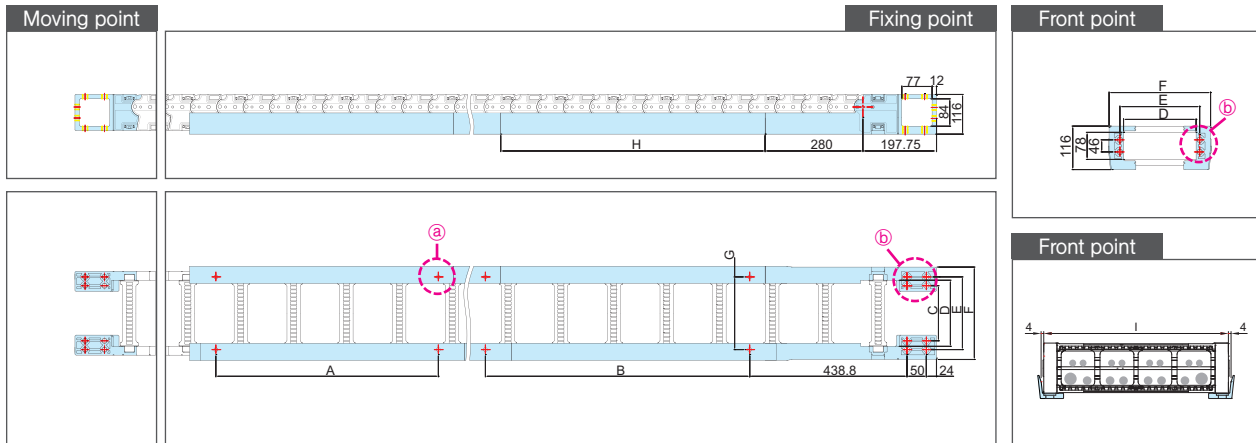
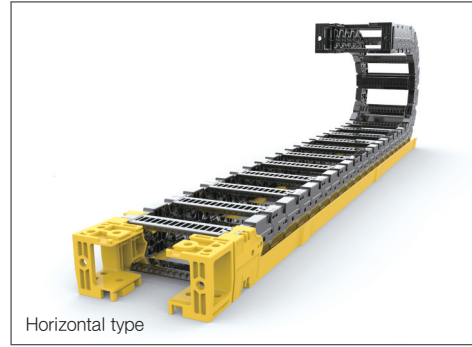
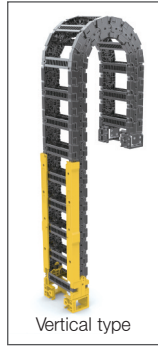

Chain Type	C FEB fix hole(inner)	D Frame	E FEB hole width	F FEB width	G GC hole width	I FEB width
nsb 075N	47	75	104	139	94	115
	72	100	129	164	119	140
	87	115	144	179	134	155
	97	125	154	189	144	165
	122	150	179	214	169	190
	147	175	204	239	194	215
	172	200	229	264	219	240
	212	240	269	304	259	280
	222	250	279	314	269	290
	262	290	319	354	309	330
	272	300	329	364	319	340
	322	350	379	414	369	390
	372	400	429	464	419	440
	422	450	479	514	469	490
	472	500	529	564	519	540
	522	550	579	614	569	590
572	600	629	664	619	640	

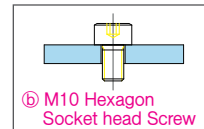
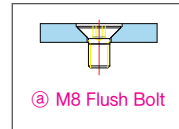

GC Type	H GC length	B GC fixing hole	A GC hole
GC600	600	601	505
GC800	800	801	705

(Dimensions in mm)

Ordering

nsb 075N, 125, R165 / F - 2000L : 10ST

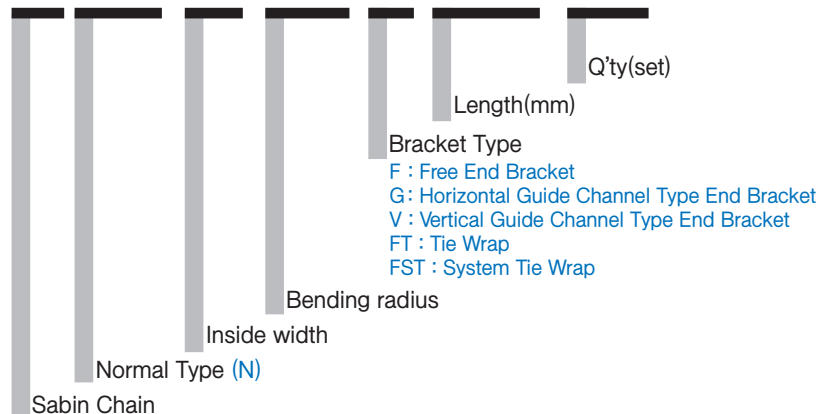

nsb028E- Unity Systems

Unity system Application method

Item	Value
Vertical type	Only 1 set of GC,FEB (End bracket) and 1pcs of GC,EC(End cap)
Horizontal type	1set of GC,FEB + 1pcs of GC,EC(End cap) + ½LS of GC(Guide channel)

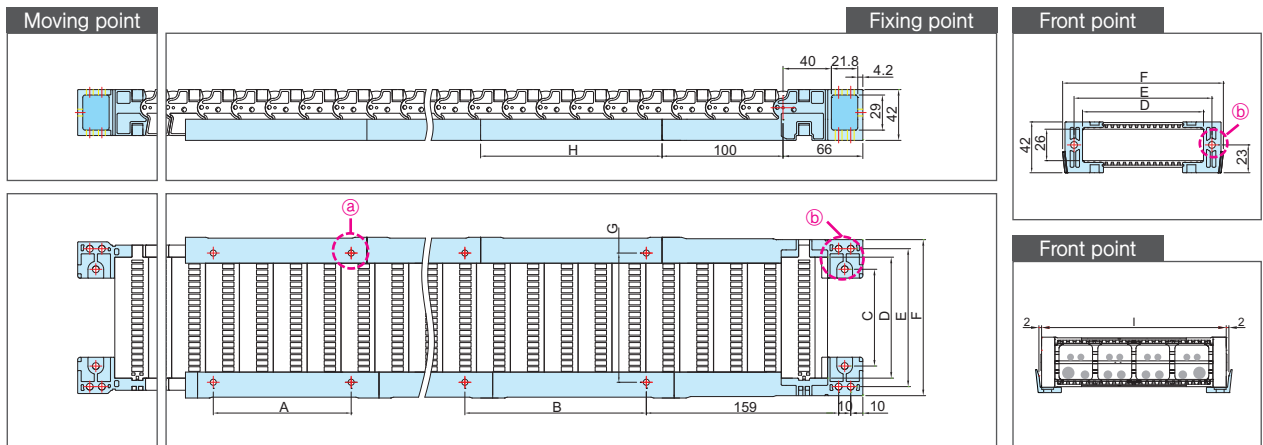
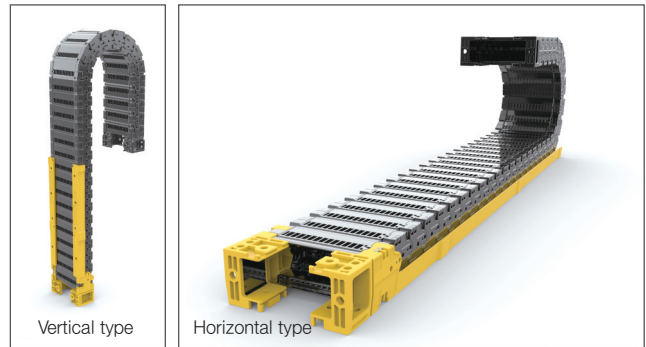

Chain Type	C FEB fix hole(inner)	D Frame	E FEB hole width	F FEB width	G GC hole width	I FEB width
nsb 028E	15	35	49	68	41.8	55
	35	55	69	88	61.8	75
	55	75	89	108	81.8	95
	80	100	114	133	106.8	120

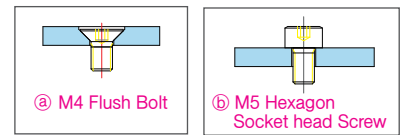

GC Type	H GC length	B GC fixing hole	A GC hole
GC150	150	151	114
GC250	250	251	214

(Dimensions in mm)

Ordering

nsb 028E. 50. R66 / F - 1000L : 10ST

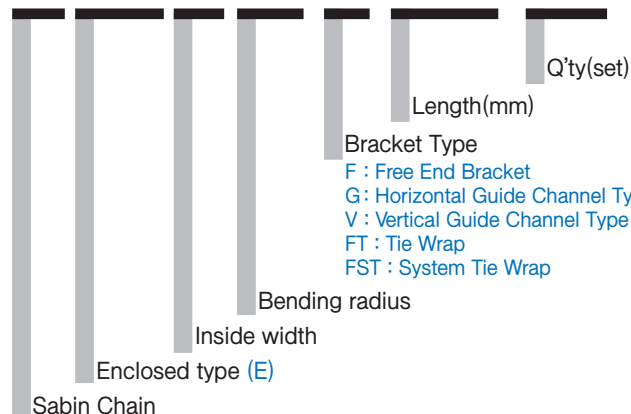

nsb035E- Unity Systems

Unity system Application method

Item	Value
Vertical type	Only 1 set of GC,FEB (End bracket) and 1pcs of GC,EC(End cap)
Horizontal type	1set of GC,FEB + 1pcs of GC,EC(End cap) + ½LS of GC(Guide channel)

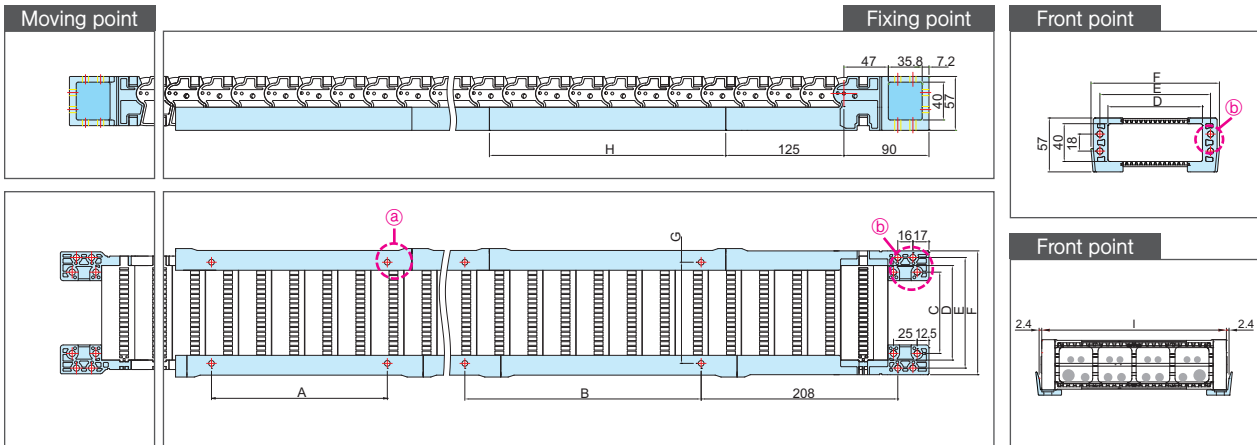
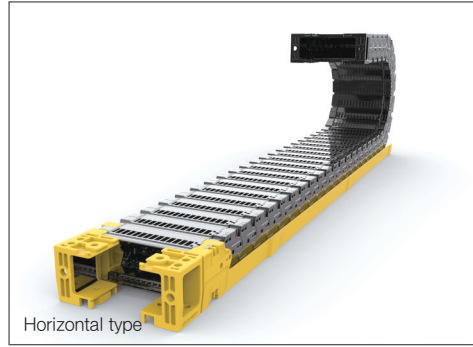
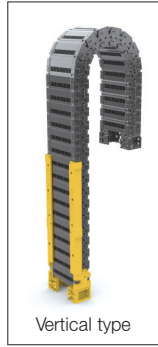

Chain Type	C FEB fix hole(inner)	D Frame	E FEB hole width	F FEB width	G GC hole width	I FEB width
nsb 035E	36	50	67	86	57	70
	61	75	92	111	82	95
	86	100	117	136	107	120
	111	125	142	161	132	145
	136	150	167	186	157	170

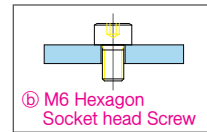
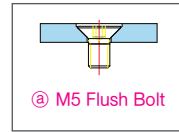

GC Type	H GC length	B GC fixing hole	A GC hole
GC250	250	251	186
GC400	400	401	336

(Dimensions in mm)

Ordering

nsb 035E, 100, R90 / F - 1500L : 10ST

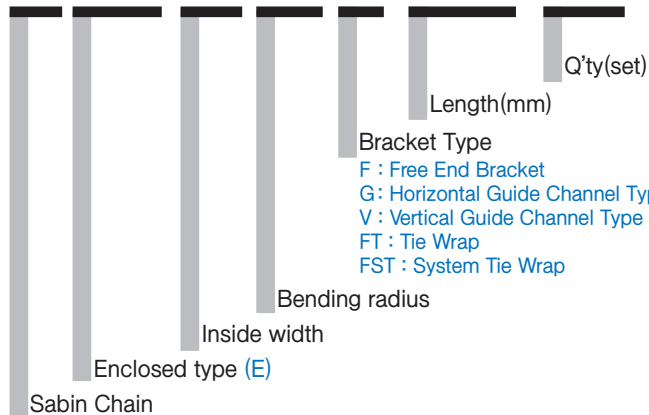

nsb045E- Unity Systems

Unity system Application method

Item	Value
Vertical type	Only 1 set of GC,FEB (End bracket) and 1pcs of GC,EC(End cap)
Horizontal type	1set of GC,FEB + 1pcs of GC,EC(End cap) + ½LS of GC(Guide channel)

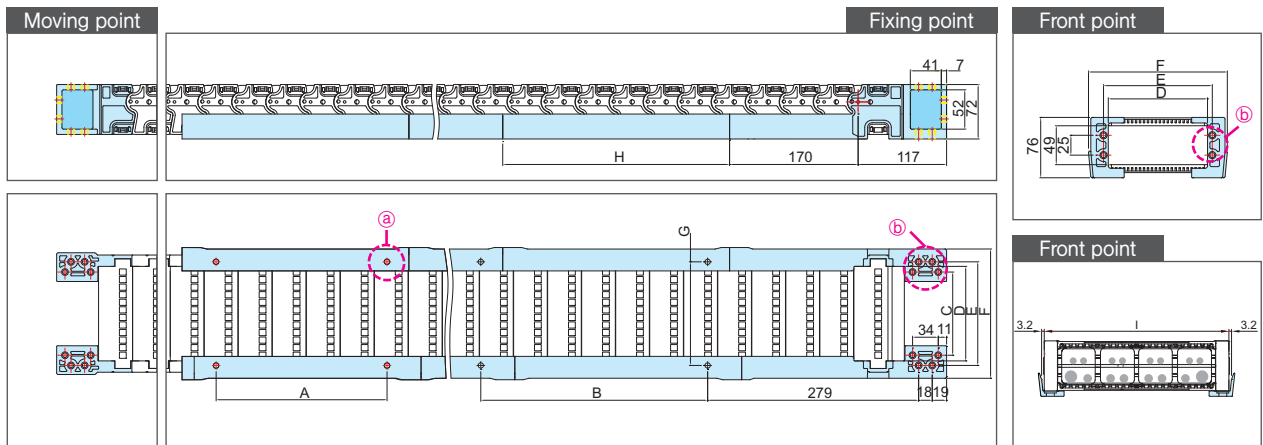
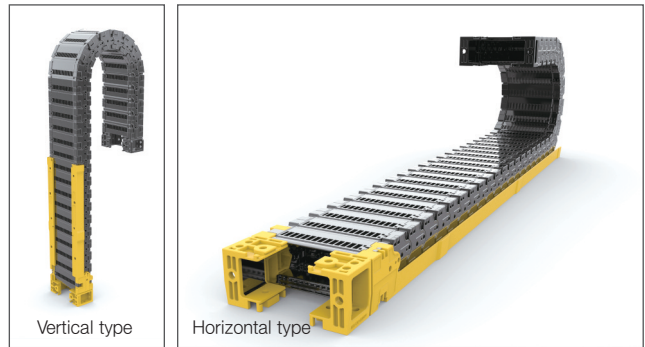

Chain Type	C FEB fix hole(inner)	D Frame	E FEB hole width	F FEB width	G GC hole width	I FEB width
nsb 045E	60	75	87	125	87	105
	85	100	112	150	112	130
	110	125	137	175	137	155
	135	150	162	200	162	180

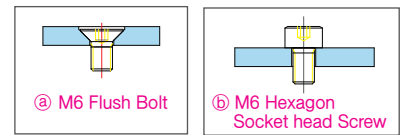

GC Type	H GC length	B GC fixing hole	A GC hole
GC300	300	301	226
GC500	500	501	426

(Dimensions in mm)

Ordering

nsb 045E. 100. R135 / F - 2000L : 10ST

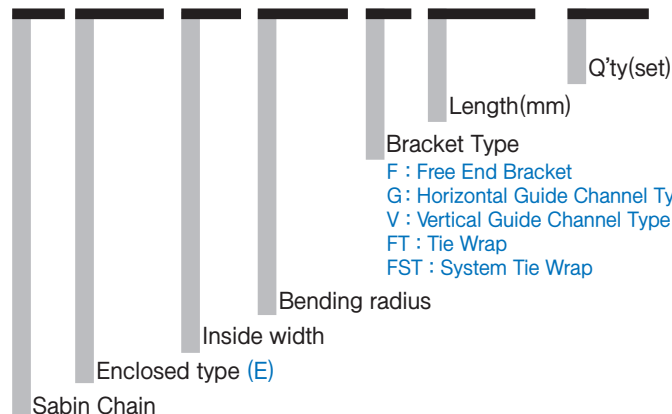

nsb060E- Unity Systems

Unity system Application method

Item	Value
Vertical type	Only 1 set of GC,FEB (End bracket) and 1pcs of GC,EC(End cap)
Horizontal type	1set of GC,FEB + 1pcs of GC,EC(End cap) + ½LS of GC(Guide channel)

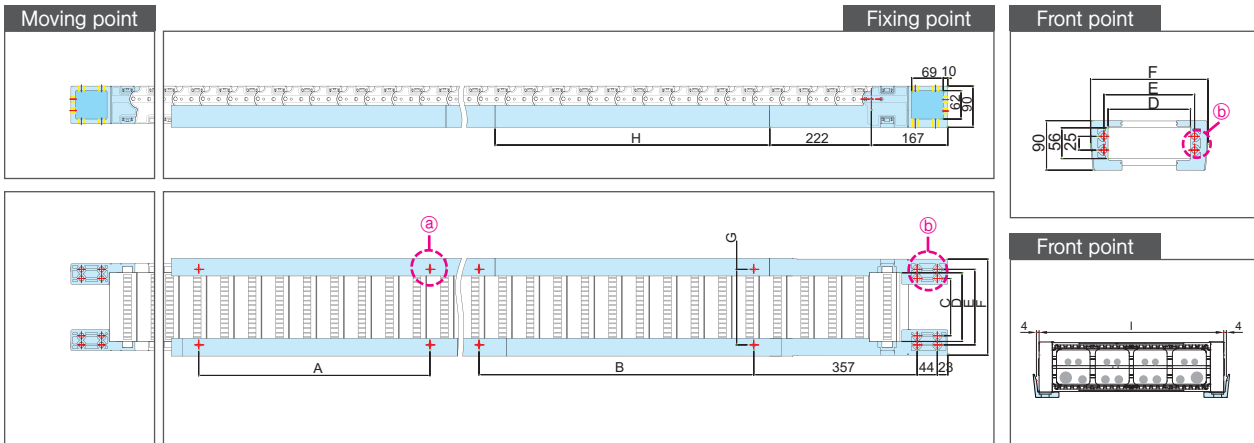
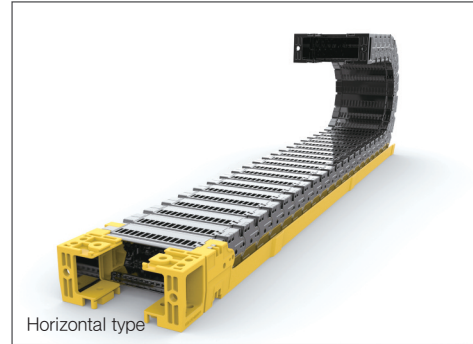
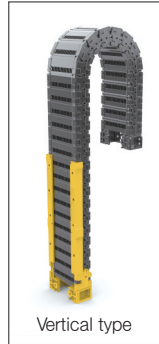

Chain Type	C FEB fix hole(inner)	D Frame	E FEB hole width	F FEB width	G GC hole width	I FEB width
nsb 060E	75	100	115	164	119	140
	125	150	165	214	169	190
	175	200	215	264	219	240

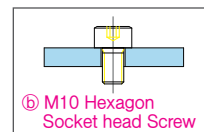
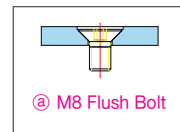

GC Type	H GC length	B GC fixing hole	A GC hole
GC600	600	601	505
GC800	800	801	705

(Dimensions in mm)

Ordering

nsb 060E, 200, R230 / F - 2000L : 10ST

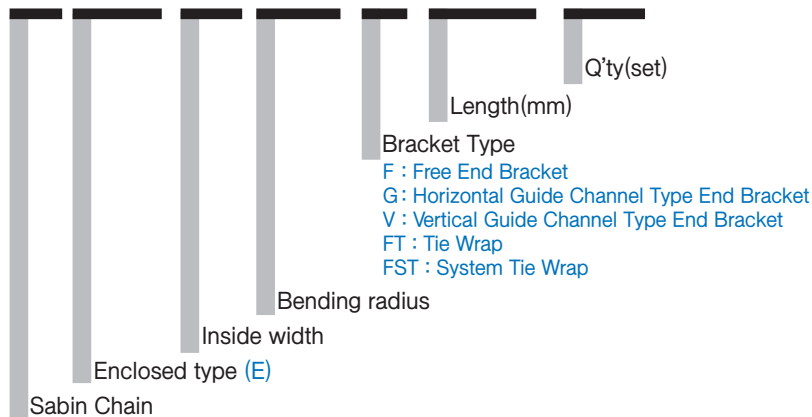

nsb075E- Unity Systems

» Unity system Application method

Item	Value
Vertical type	Only 1 set of GC,FEB (End bracket) and 1pcs of GC,EC(End cap)
Horizontal type	1set of GC,FEB + 1pcs of GC,EC(End cap) + ½LS of GC(Guide channel)

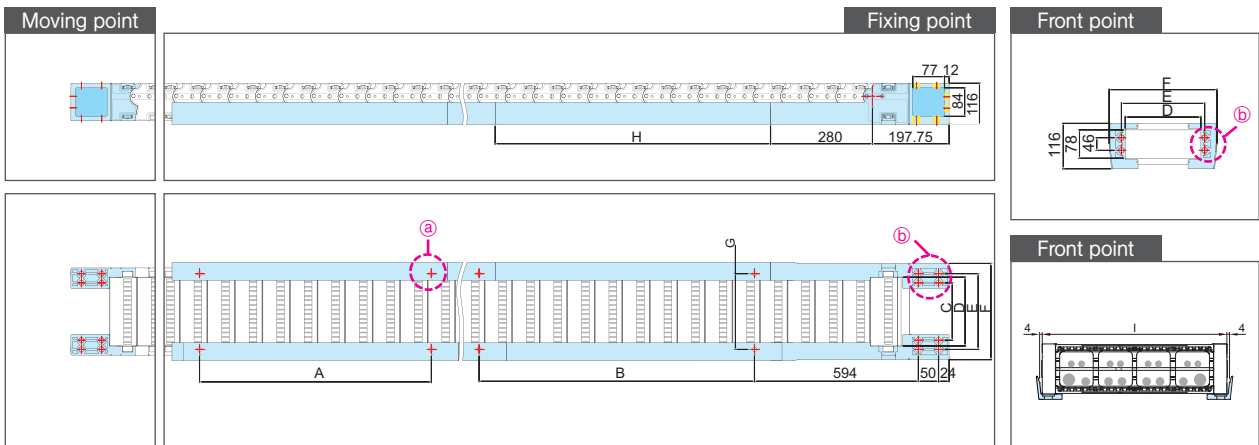
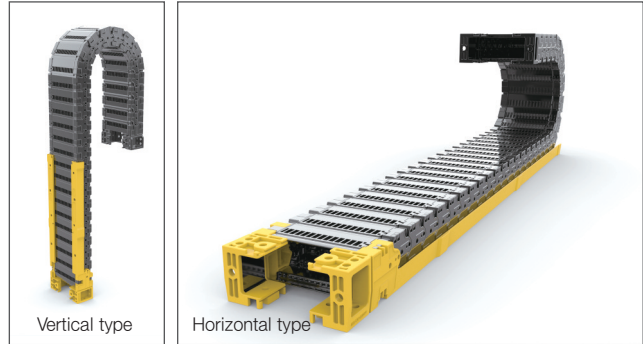

Chain Type	C FEB fix hole(inner)	D Frame	E FEB hole width	F FEB width	G GC hole width	I FEB width
nsb 075E	122	150	179	214	169	190
	172	200	229	264	219	240
	272	300	329	364	319	340

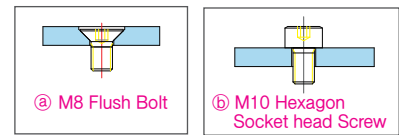

GC Type	H GC length	B GC fixing hole	A GC hole
GC600	600	601	505
GC800	800	801	705

(Dimensions in mm)

» Ordering

nsb 075E. 300. R330 / F - 2500L : 10ST

