

EX-30 SERIES Ver.2

Related Information

- General terms and conditions..... F-7
- Sensor selection guide..... P.271~
- Glossary of terms..... P.1455~
- General precautions P.1458~



panasonic.net/id/pidsx/global

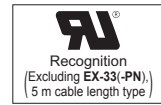

PNP output type available

The next-generation new form series A new alternative to fiber sensors

Simpler design

All you need to do is to make a $\varnothing 4$ mm $\varnothing 0.157$ in hole where you would like to stop or check the object ($\varnothing 6$ mm $\varnothing 0.236$ in hole for reflective type). Furthermore, the center of the sensing axis is the same as the center of the mounting hole, which makes it much easier to set the sensing position.

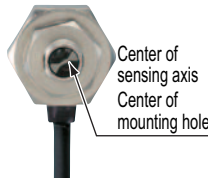

New design solves all weak points of fiber sensors

The EX-30 series solves all of the difficulties associated with fiber sensors, such as:

- Difficulty finding a suitable place for the amplifier
- Fragility of the fiber
- Extra space needed because of difficulty in bending the fiber
- The nuisance of having to use a protective tube to prevent fiber breakage

BASIC PERFORMANCE

Electric power saving*

The EX-30 series achieves reductions in power consumption of up to 65%. These sensors contribute to environmental friendliness.

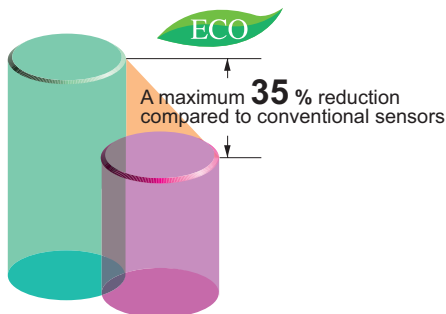

*Effective from production in April 2011.

Long sensing range

The EX-30 series achieves long distance sensing [thru-beam type: 500 mm **19.685 in** (EX-33(-PN): 800 mm **31.496 in**), reflective type: 50 mm **1.969 in**.]



Globally usable

It conforms to the EMC Directive and obtains the UL Recognition. (excluding 5 m **16.405 ft** cable length type) Moreover, PNP output type which is much in demand in Europe, is also available.

High response speed of 0.5 ms

The same high response speed of 0.5 ms as fiber sensor amplifiers is provided, making these sensors ideal for sensing small objects, counting objects that are moving quickly and positioning items such as circuit boards.

Selection Guide
Amplifier Built-in
Power Supply Built-in
Amplifier-separated
CX-400
CY-100
EX-10
EX-20
EX-30
EX-40
CX-440
EQ-30
EQ-500
MQ-W
RX-LS200
RX
RT-610

APPLICATIONS

Detecting IC height

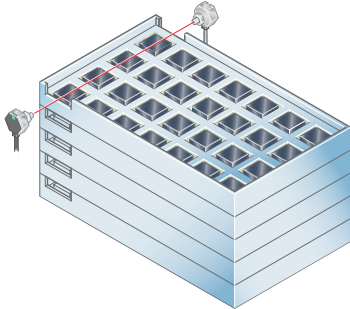

Detecting quantity of labels in label magazine

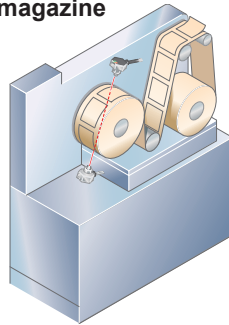

Checking IC pins (using slit masks)

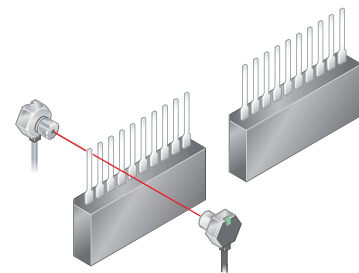

VARIETIES

New thru-beam types now feature operation mode switch and sensitivity adjuster! **EX-33(-PN)**

EX-33(-PN)



- ① Operation mode switch
- ② Sensitivity adjuster
- ③ Bright 2-color indicator

Switching between light-ON and dark-ON operating modes is possible with a single model.

It is convenient when you need fine adjustment.

A bright 2-color indicator has been incorporated in all types.



Receiver

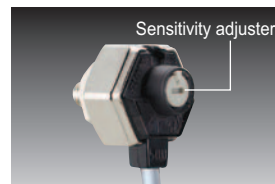

Emitter

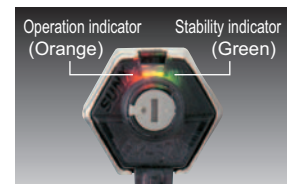

Receiver

MOUNTING / SIZE

Can be installed in the same way as standard fibers

The EX-30 series can be screwmounted (M4 for thru-beam type, M6 for reflective type) in the same way as standard fiber sensors. This means that they can be inserted into production lines in exactly the same way as conventional high-priced fiber sensors.

Single-point tightening cuts down on installation work by half

Conventional photoelectric sensors required four (for thru-beam type) or two (for reflective type) mounting holes and screws to be used. However, the EX-30 series is installed with a single screw, thus cutting down on installation work by half.

M4

Thru-beam type
(Reflective type: M6)

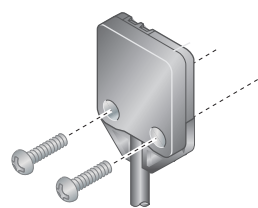

Conventional model

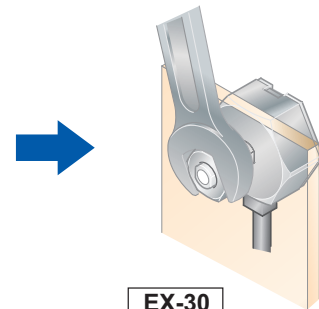

EX-30

Takes up very little space

Unlike conventional fibers, bending radius is not a problem, so that the sensor can be securely installed alongside conveyors.

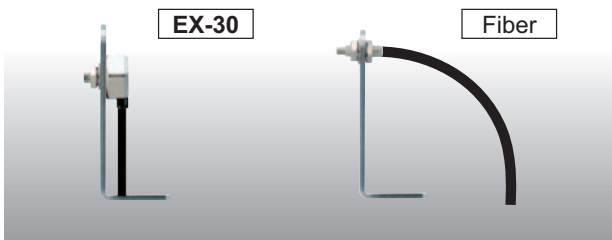

FIBER SENSORS

LASER SENSORS

PHOTOELECTRIC SENSORS

MICRO PHOTOELECTRIC SENSORS

AREA SENSORS

LIGHT CURTAINS / SAFETY COMPONENTS

PRESSURE / FLOW SENSORS

INDUCTIVE PROXIMITY SENSORS

PARTICULAR USE SENSORS

SENSOR OPTIONS

SIMPLE WIRE-SAVING UNITS

WIRE-SAVING SYSTEMS

MEASUREMENT SENSORS

STATIC ELECTRICITY PREVENTION DEVICES

LASER MARKERS

PLC

HUMAN MACHINE INTERFACES

ENERGY CONSUMPTION VISUALIZATION COMPONENTS

FA COMPONENTS

MACHINE VISION SYSTEMS

UV CURING SYSTEMS

Selection Guide

Amplifier Built-in

Power Supply Built-in

Amplifier-separated

CX-400

CY-100

EX-10

EX-20

EX-30

EX-40

CX-440

EQ-30

EQ-500

MQ-W

RX-LS200

RX

RT-610

- FIBER SENSORS
- LASER SENSORS
- PHOTOELECTRIC SENSORS
- MICRO PHOTOELECTRIC SENSORS
- AREA SENSORS
- LIGHT CURTAINS / SAFETY COMPONENTS
- PRESSURE / FLOW SENSORS
- INDUCTIVE PROXIMITY SENSORS
- PARTICULAR USE SENSORS
- SENSOR OPTIONS
- SIMPLE WIRE-SAVING UNITS
- WIRE-SAVING SYSTEMS
- MEASUREMENT SENSORS
- STATIC ELECTRICITY PREVENTION DEVICES
- LASER MARKERS
- PLC
- HUMAN MACHINE INTERFACES
- ENERGY CONSUMPTION VISUALIZATION COMPONENTS
- FA COMPONENTS
- MACHINE VISION SYSTEMS
- UV CURING SYSTEMS
- Selection Guide
- Amplifier Built-in
- Power Supply Built-in
- Amplifier-separated
- CX-400
- CY-100
- EX-10
- EX-20
- EX-30
- EX-40
- CX-440
- EQ-30
- EQ-500
- MQ-W
- RX-LS200
- RX
- RT-610

ENVIRONMENTAL RESISTANCE

Incorporated an inverter countermeasure circuit*

The **EX-30** series become significantly stronger against inverter light and other extraneous light.

*Effective from production in April 2011.

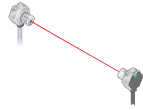

No protective tube needed

The **EX-30** series has high bending strength, so that the protective tube used to protect conventional fiber from breakage is not needed. This also adds up to excellent cost performance.



Waterproof IP67 (IEC)

The sensor can be hosed down because of its IP67 construction.

Note: However, take care that if it is exposed to water splashes during operation, it may detect a water drop itself.

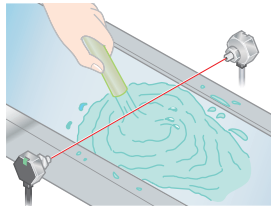

FUNCTIONS

Bright 2-color indicator

A bright 2-color indicator is incorporated in all types.

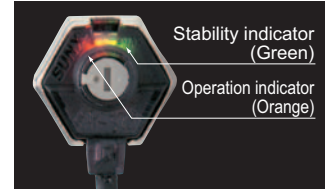

OPERABILITY

Incorporates a sensitivity adjuster (Excluding EX-31□)

The sensor incorporates a sensitivity adjuster. It is convenient when you need fine adjustment.

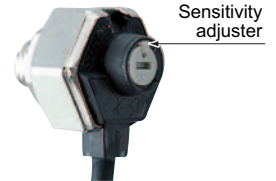

ORDER GUIDE

Type	Appearance	Sensing range	Model No. (Note)	Output	Output operation
Thru-beam			EX-31A	NPN open-collector transistor	Light-ON
			EX-31B		Dark-ON
			EX-31A-PN	PNP open-collector transistor	Light-ON
			EX-31B-PN		Dark-ON
With operation mode switch			EX-33	NPN open-collector transistor	Switchable either Light-ON or Dark-ON
			EX-33-PN	PNP open-collector transistor	
Diffuse reflective			EX-32A	NPN open-collector transistor	Light-ON
			EX-32B		Dark-ON
			EX-32A-PN	PNP open-collector transistor	Light-ON
			EX-32B-PN		Dark-ON

Note: The model No. with "P" shown on the label affixed to the thru-beam type sensor is the emitter, "D" shown on the label is the receiver.

5 m 16.404 ft cable length type

5 m 16.404 ft cable length type (standard: 2 m 6.562 ft) is also available for NPN output type [excluding EX-33(-PN)]. When ordering this type, suffix "-C5" to the model No. (e.g.) 5 m 16.404 ft cable length type of EX-31A is "EX-31A-C5".

OPTIONS

Designation	Model No.	Description
Slit mask (For thru-beam type sensor only)	OS-EX30-1 (Slit size $\phi 1$ mm) $\phi 0.039$ in	Slit on one side
		Slit on both sides

Note: One slit and two spacers are provided per set. Two sets are required when installing on both sides.

Slit mask

• OS-EX30-1

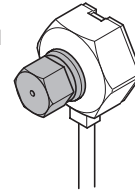

Apply the optional slit mask when detecting small objects or for increasing the accuracy of sensing position. However, the sensing range is reduced when the slit mask is mounted.

SPECIFICATIONS

Item	Type	Thru-beam			Diffuse reflective	
		EX-31A	EX-31B	EX-33	EX-32A	EX-32B
	NPN output	EX-31A	EX-31B	EX-33	EX-32A	EX-32B
	PNP output	EX-31A-PN	EX-31B-PN	EX-33-PN	EX-32A-PN	EX-32B-PN
Sensing range		500 mm 19.685 in		800 mm 31.496 in	50 mm 1.969 in (Note 2)	
Sensing object		$\phi 2$ mm $\phi 0.079$ in or more opaque object (Completely beam interrupted objects)			Opaque, translucent or transparent object (Note 3)	
Hysteresis		—			15 % or less of operation distance (Note 2)	
Repeatability (perpendicular to sensing axis)		0.05 mm 0.002 in or less			0.5 mm 0.020 in or less	
Supply voltage		12 to 24 V DC ± 10 % Ripple P-P 10 % or less				
Current consumption		Emitter: 10 mA or less, Receiver: 10 mA or less			13 mA or less	
Output		<NPN output type> NPN open-collector transistor • Maximum sink current: 50 mA • Applied voltage: 30 V DC or less (between output and 0 V) • Residual voltage: 2 V or less (at 50 mA sink current) 1 V or less (at 16 mA sink current)			<PNP output type> PNP open-collector transistor • Maximum source current: 50 mA • Applied voltage: 30 V DC or less (between output and +V) • Residual voltage: 2 V or less (at 50 mA source current) 1 V or less (at 16 mA source current)	
	Utilization category	DC-12 or DC-13				
	Output operation	Light-ON	Dark-ON	Switchable either Light-ON or Dark-ON	Light-ON	Dark-ON
	Short-circuit protection	Incorporated				
Response time		0.5 ms or less				
Operation indicator		Orange LED (lights up when the output is ON) (incorporated on the receiver for thru-beam type)				
Stability indicator		Green LED (lights up under stable light received condition or stable dark condition, incorporated on the receiver)			Green LED (lights up under stable light received condition or stable dark condition)	
Sensitivity adjuster		—			Continuously variable adjuster	
Environmental resistance	Pollution degree	3 (Industrial environment)				
	Protection	IP67 (IEC)				
	Ambient temperature	-25 to +55 °C -13 to +131 °F (No dew condensation or icing allowed), Storage: -30 to +70 °C -22 to +158 °F				
	Ambient humidity	35 to 85 % RH, Storage: 35 to 85 % RH				
	Ambient illuminance	Incandescent light: 3,000 lx at the light-receiving face				
	EMC	EN 60947-5-2				
	Voltage withstandability	1,000 V AC for one min. between all supply terminals connected together and enclosure				
	Insulation resistance	20 M Ω , or more, with 250 V DC megger between all supply terminals connected together and enclosure				
	Vibration resistance	10 to 500 Hz frequency, 3 mm 0.118 in amplitude (20 G max.) in X, Y and Z directions for two hours each				
Shock resistance	500 m/s ² acceleration (50 G approx.) in X, Y and Z directions for three times each					
Emitting element		Red LED (modulated)				
Material		Enclosure: Die-cast zinc (Nickel plated), Lens: Polycarbonate [EX-32□(-PN): Acrylic], Enclosure cover: Polycarbonate				
Cable		0.1 mm ² 3-core (thru-beam type sensor emitter: 2-core) cabtyre cable, 2 m 6.562 ft long				
Cable extension		Extension up to total 50 m 164.042 ft is possible with 0.3 mm ² , or more, cable (thru-beam type: both emitter and receiver).				
Weight		Net weight (each emitter and receiver): 20 g approx. Gross weight: 65 g approx.			Net weight: 20 g approx., Gross weight: 45 g approx.	
Accessories		Nut: 2 pcs., Toothed lock washer: 2 pcs.			Nut: 1 pc., Toothed lock washer: 1 pc.	

Notes: 1) Where measurement conditions have not been specified precisely, the conditions used were an ambient temperature of +23 °C +73.4 °F.
 2) The sensing range and the hysteresis are specified for white non-glossy paper (100 × 100 mm 3.937 × 3.937 in) as the object.
 3) Make sure to confirm detection with an actual sensor before use.

FIBER SENSORS
 LASER SENSORS
 PHOTO-ELECTRIC SENSORS
 MICRO PHOTO-ELECTRIC SENSORS
 AREA SENSORS
 LIGHT CURTAINS / SAFETY COMPONENTS
 PRESSURE / FLOW SENSORS
 INDUCTIVE PROXIMITY SENSORS
 PARTICULAR USE SENSORS
 SENSOR OPTIONS
 SIMPLE WIRE-SAVING UNITS
 WIRE-SAVING SYSTEMS
 MEASUREMENT SENSORS
 STATIC ELECTRICITY PREVENTION DEVICES
 LASER MARKERS
 PLC
 HUMAN MACHINE INTERFACES
 ENERGY CONSUMPTION VISUALIZATION COMPONENTS
 FA COMPONENTS
 MACHINE VISION SYSTEMS
 UV CURING SYSTEMS
 Selection Guide
 Amplifier Built-in
 Power Supply Built-in
 Amplifier-separated
CX-400
CY-100
EX-10
EX-20
EX-30
EX-40
CX-440
EQ-30
EQ-500
MQ-W
RX-LS200
RX
RT-610

FIBER SENSORS

LASER SENSORS

PHOTO-ELECTRIC SENSORS

MICRO PHOTO-ELECTRIC SENSORS

AREA SENSORS

LIGHT CURTAINS/ SAFETY COMPONENTS

PRESSURE/ FLOW SENSORS

INDUCTIVE PROXIMITY SENSORS

PARTICULAR USE SENSORS

SENSOR OPTIONS

SIMPLE WIRE-SAVING UNITS

WIRE-SAVING SYSTEMS

MEASUREMENT SENSORS

STATIC ELECTRICITY PREVENTION DEVICES

LASER MARKERS

PLC

HUMAN MACHINE INTERFACES

ENERGY CONSUMPTION VISUALIZATION COMPONENTS

FA COMPONENTS

MACHINE VISION SYSTEMS

UV CURING SYSTEMS

I/O CIRCUIT AND WIRING DIAGRAMS

NPN output type

I/O circuit diagram

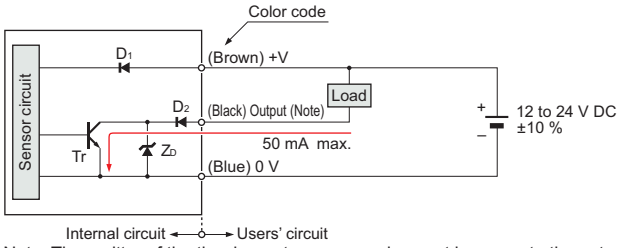

Wiring diagram

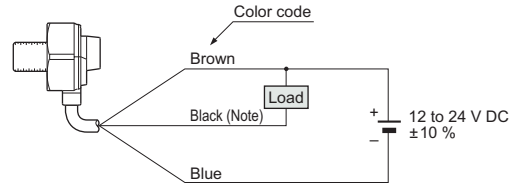

Note: The emitter of the thru-beam type sensor does not incorporate the black wire.

Note: The emitter of the thru-beam type sensor does not incorporate the output.

Symbols ... D1: Reverse supply polarity protection diode
D2: Reverse output polarity protection diode
ZD: Surge absorption zener diode
Tr: NPN output transistor

PNP output type

I/O circuit diagram

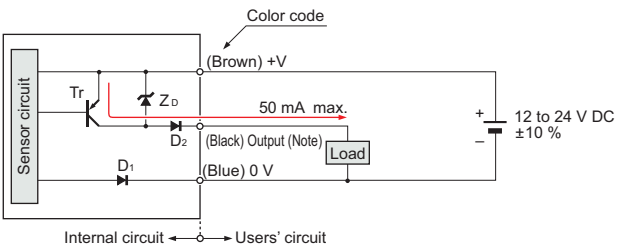

Wiring diagram

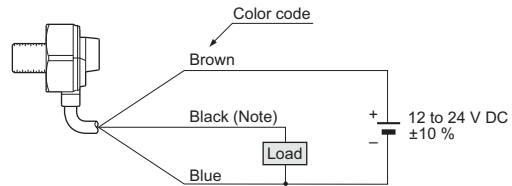

Note: The emitter of the thru-beam type sensor does not incorporate the black wire.

Note: The emitter of the thru-beam type sensor does not incorporate the output.

Symbols ... D1: Reverse supply polarity protection diode
D2: Reverse output polarity protection diode
ZD: Surge absorption zener diode
Tr: PNP output transistor

SENSING CHARACTERISTICS (TYPICAL)

EX-31 □ EX-31 □-PN Thru-beam type

Parallel deviation

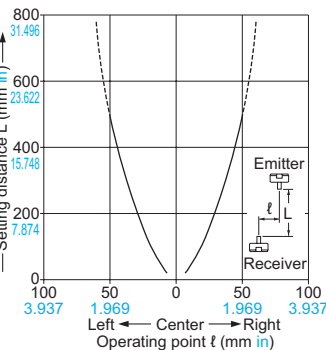

Angular deviation

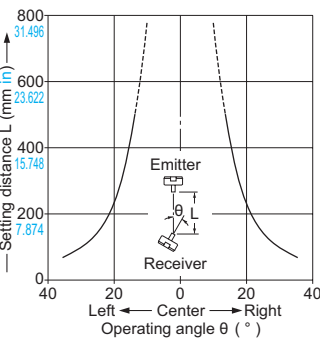

Parallel deviation with slit mask on one side

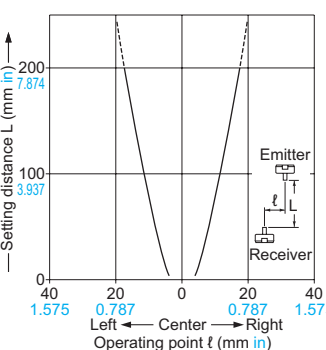

Parallel deviation with slit masks on both sides

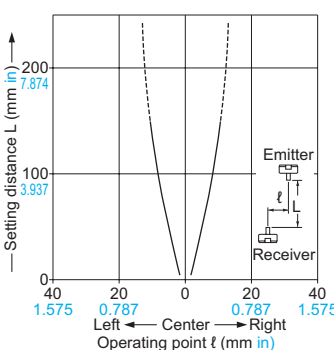

EX-31 □ EX-31 □-PN Thru-beam type

Correlation between setting distance and excess gain

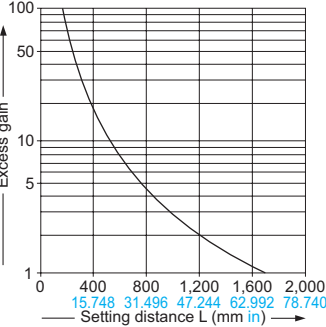

EX-32 □ EX-32 □-PN

Sensing field

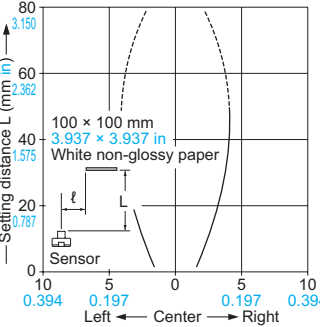

Diffuse reflective type

Correlation between sensing object size and sensing range

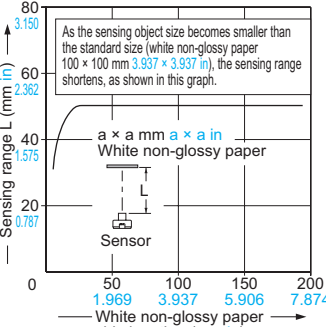

Correlation between setting distance and excess gain

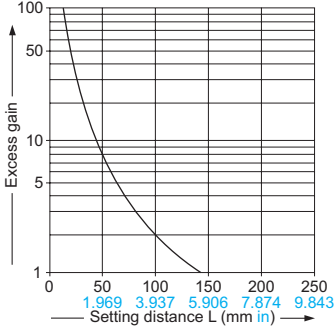

Selection Guide
Amplifier Built-in
Power Supply Built-in
Amplifier-separated

CX-400

CY-100

EX-10

EX-20

EX-30

EX-40

CX-440

EQ-30

EQ-500

MQ-W

RX-LS200

RX

RT-610

SENSING CHARACTERISTICS (TYPICAL)

EX-33 EX-33-PN

Thru-beam type

Parallel deviation

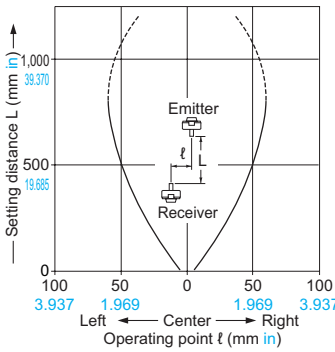

Angular deviation

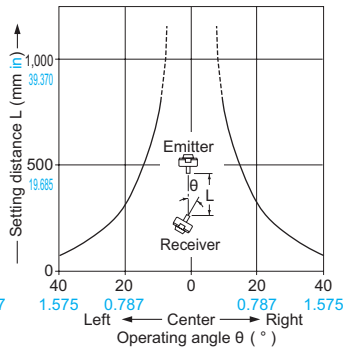

Parallel deviation with slit mask on one side

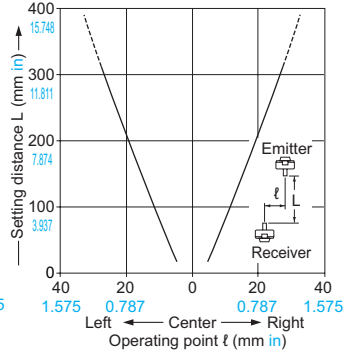

Parallel deviation with slit masks on both sides

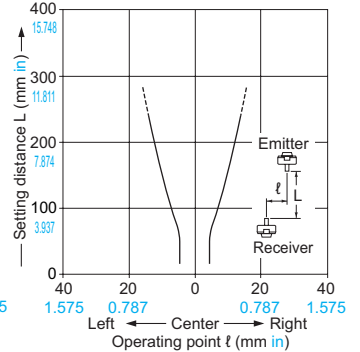

PRECAUTIONS FOR PROPER USE

Refer to p.1458~ for general precautions.



- Never use this product as a sensing device for personnel protection.
- In case of using sensing devices for personnel protection, use products which meet laws and standards, such as OSHA, ANSI or IEC etc., for personnel protection applicable in each region or country.

- Do not use during the initial transient time (50 ms) after the power supply is switched on.
- In case of using the sensor at a place where static electricity is generated, use a metal mounting plate. Also, ensure to ground the mounting plate.

DIMENSIONS (Unit: mm in)

The CAD data in the dimensions can be downloaded from our website

EX-31 EX-31-PN

Sensor

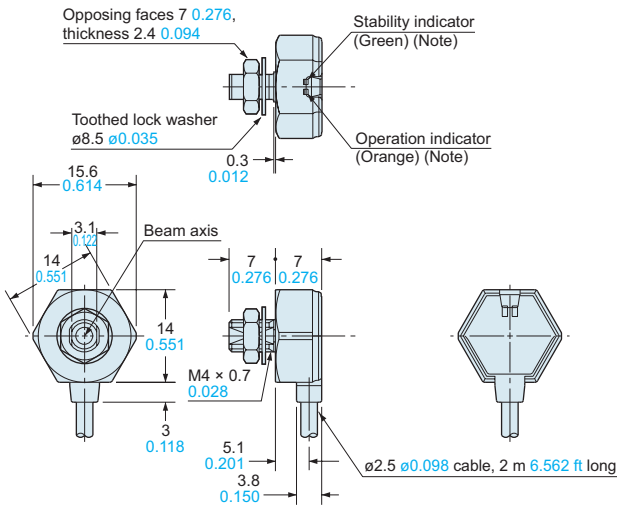

Note: Not incorporated on the emitter.

EX-33 EX-33-PN

Sensor

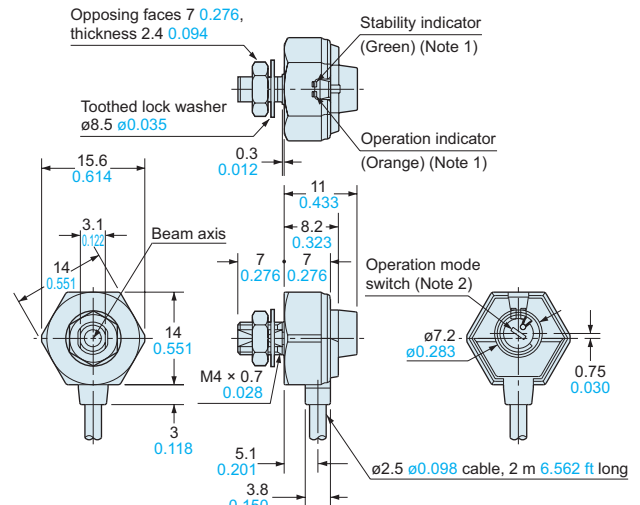

Notes: 1) Not incorporated on the emitter.
2) It is the sensitivity adjuster on the emitter.

EX-32 EX-32-PN

Sensor

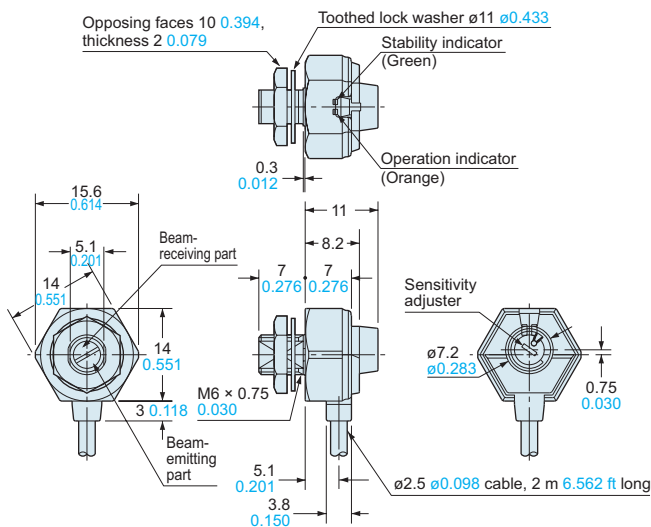

OS-EX30-1

Slit mask (optional)

Slit mask

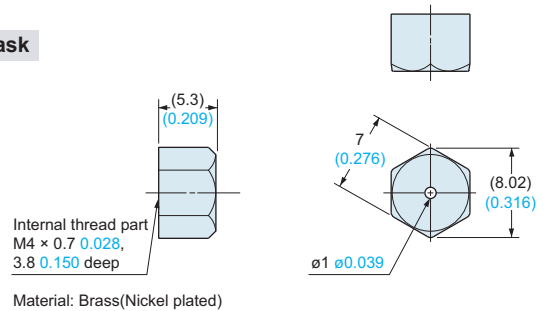

Spacer

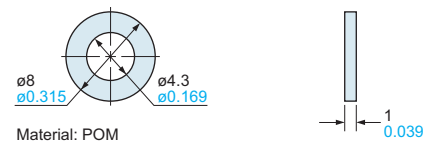

FIBER SENSORS

LASER SENSORS

PHOTO-ELECTRIC SENSORS

MICRO PHOTO-ELECTRIC SENSORS

AREA SENSORS

LIGHT CURTAINS / SAFETY COMPONENTS

PRESSURE / FLOW SENSORS

INDUCTIVE PROXIMITY SENSORS

PARTICULAR USE SENSORS

SENSOR OPTIONS

SIMPLE WIRE-SAVING UNITS

WIRE-SAVING SYSTEMS

MEASUREMENT SENSORS

STATIC ELECTRICITY PREVENTION DEVICES

LASER MARKERS

PLC

HUMAN MACHINE INTERFACES

ENERGY CONSUMPTION VISUALIZATION COMPONENTS

FA COMPONENTS

MACHINE VISION SYSTEMS

UV CURING SYSTEMS

Selection Guide

Amplifier Built-in

Power Supply Built-in

Amplifier Separated

CX-400

CY-100

EX-10

EX-20

EX-30

EX-40

CX-440

EQ-30

EQ-500

MQ-W

RX-LS200

RX

RT-610