

Tipo / Type
3F

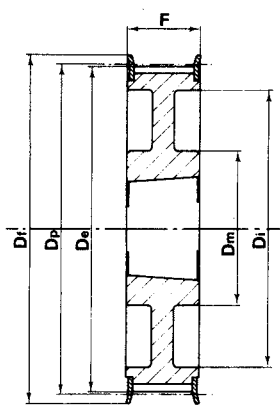

Tipo / Type
3WF

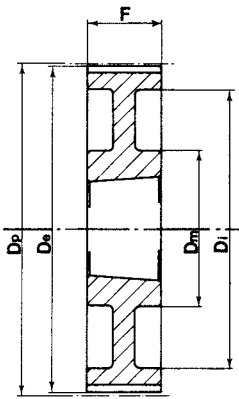

Tipo / Type
3W

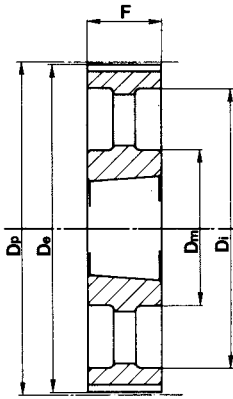

Tipo / Type
3A

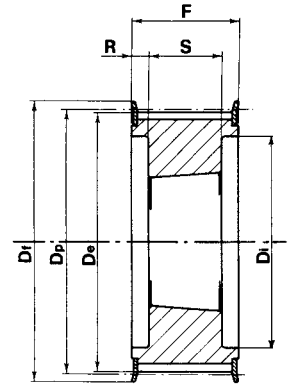

Tipo / Type
4F

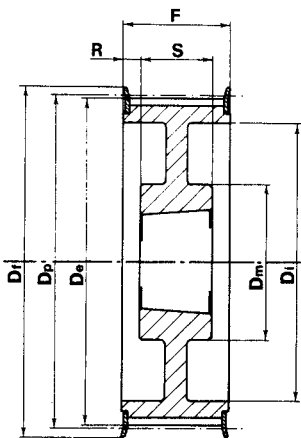

Tipo / Type
4WF

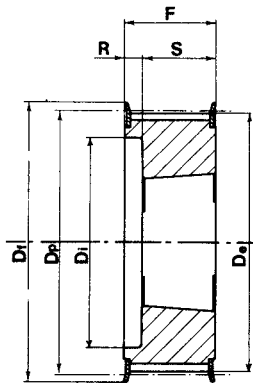

Tipo / Type
5F

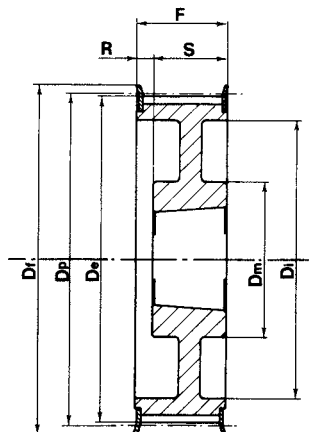

Tipo / Type
5WF

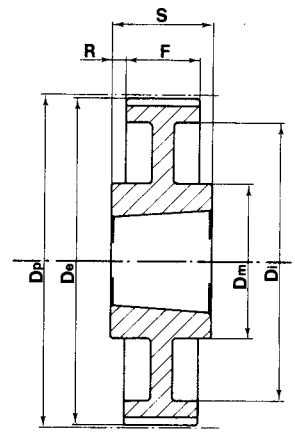

Tipo / Type
7W

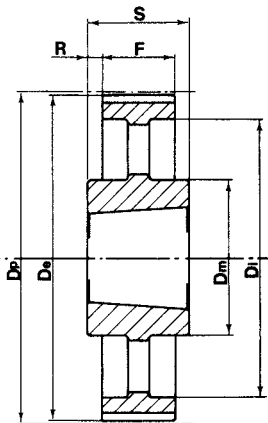

Tipo / Type
7A

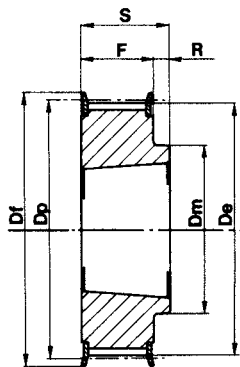

Tipo / Type
8F

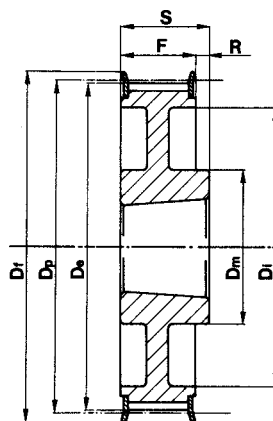

Tipo / Type
8WF

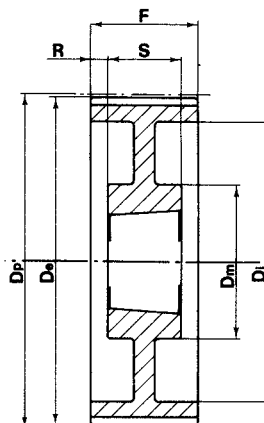

Tipo / Type
9W

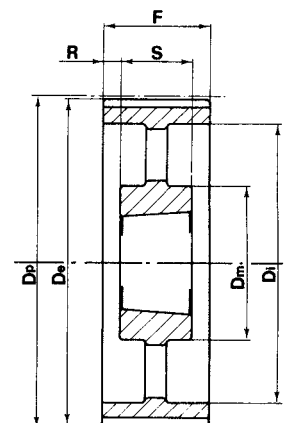

Tipo / Type
9A

Pulegge dentate per bussola conica / Timing belt pulleys for taper bushes
Zahnriemenscheiben für Spannbüchsen / Poulies dentées à moyeu amovible
Poleas dentadas para casquillos cónicos (taper)



XH 200 - 7/8" (22,225 mm)

Caratteristiche Features Merkmale Características	Codice Code symbol Fabriknummer Code symbole Numero de fabrica	Nostro codice Our code Unser kode Notre code Nuestro codiggo	Tipo Type Typ Type Tipo	Codice flangia Flange code Bordscheiben-Code Code flasque Código brida	Bussola Bush Buchse Moyeu Casquillo	Foro max. Max. Bore Max. Bohrung Alesage max. Agujero max.	Dp	De	Df	Dm	Di	F	S	R	Peso Weight / Gewicht Poids / Peso Kg
Ghisa / Cast iron Grauguss / Fonte Hierro fundido	con flangia / with flanges mit Flanges / avec flasques / con tapetas	18XH200	TXH2018	5F	FL155	2517	60	127,34	124,55	140,0	-	95	64	45	19,0
		20XH200	TXH2020	5F	FL157	2517	60	141,49	138,69	155,0	-	110	64	45	19,0
		22XH200	TXH2022	5F	FL159	2517	60	155,64	152,84	170,0	-	120	64	45	19,0
		24XH200	TXH2024	5F	FL161	2517	60	169,79	166,99	184,0	-	135	64	45	19,0
		26XH200	TXH2026	5F	FL163	2517	60	183,94	181,14	198,0	-	150	64	45	19,0
		28XH200	TXH2028	4WF	FL165	2517	60	198,08	195,29	212,0	120	165	64	45	9,5
		30XH200	TXH2030	4WF	FL167	2517	60	212,23	209,44	227,0	120	180	64	45	9,5
		32XH200	TXH2032	4WF	FL169	2517	60	226,38	223,59	240,0	120	195	64	45	9,5
	40XH200	TXH2040	4WF	FL177	3020	75	282,98	280,18	297,0	160	245	64	51	9,5	
	senza flangia / without flanges ohne Flanschen / sans flasques sin tapetas	48XH200	TXH2048	9W	-	3020	75	339,57	336,78	-	160	300	64	51	6,5
		60XH200	TXH2060	7A	-	3535	90	424,47	421,67	-	190	385	64	89	12,5
		72XH200	TXH2072	7A	-	3535	90	509,40	506,56	-	190	470	64	89	12,5
		84XH200	TXH2084	7A	-	3535	90	594,25	591,46	-	190	555	64	89	12,5
		96XH200	TXH2096	7A	-	3535	90	679,15	676,35	-	190	640	64	89	12,5
		120XH200	TXH2120	7A	-	3535	90	848,93	846,14	-	190	810	64	89	12,5

XH 300 - 7/8" (22,225 mm)

Caratteristiche Features Merkmale Características	Codice Code symbol Fabriknummer Code symbole Numero de fabrica	Nostro codice Our code Unser kode Notre code Nuestro codiggo	Tipo Type Typ Type Tipo	Codice flangia Flange code Bordscheiben-Code Code flasque Código brida	Bussola Bush Buchse Moyeu Casquillo	Foro max. Max. Bore Max. Bohrung Alesage max. Agujero max.	Dp	De	Df	Dm	Di	F	S	R	Peso Weight / Gewicht Poids / Peso Kg
Ghisa / Cast iron Grauguss / Fonte Hierro fundido	con flangia / with flanges mit Flanges / avec flasques / con tapetas	18XH300	TXH3018	5F	FL155	2517	60	127,34	124,55	140,0	-	95	90	45,0	45,0
		20XH300	TXH3020	5F	FL157	2517	60	141,49	138,69	155,0	-	110	90	45,0	45,0
		22XH300	TXH3022	5F	FL159	2517	60	155,64	152,84	170,0	-	120	90	45,0	45,0
		24XH300	TXH3024	5F	FL161	2517	60	169,79	166,99	184,0	-	135	90	45,0	45,0
		26XH300	TXH3026	5F	FL163	2517	60	183,94	181,14	198,0	-	150	90	45,0	45,0
		28XH300	TXH3028	5F	FL165	3020	75	198,08	195,29	212,0	-	165	90	51,0	39,0
		30XH300	TXH3030	5F	FL167	3020	75	212,23	209,44	227,0	-	180	90	51,0	39,0
		32XH300	TXH3032	5F	FL169	3020	75	226,38	223,59	240,0	-	195	90	51,0	39,0
	40XH300	TXH3040	4WF	FL177	3020	75	282,98	280,18	297,0	160	245	90	51,0	19,5	
	senza flangia / without flanges ohne Flanschen / sans flasques sin tapetas	48XH300	TXH3048	9A	-	3020	75	339,57	336,78	-	160	300	90	51,0	19,5
		60XH300	TXH3060	9A	-	3535	90	424,47	421,67	-	190	385	90	89,0	0,5
		72XH300	TXH3072	9A	-	3535	90	509,40	506,56	-	190	470	90	89,0	0,5
		84XH300	TXH3084	7A	-	4040	100	594,25	591,46	-	190	555	90	102,0	6,0
		96XH300	TXH3096	7A	-	4040	100	679,15	676,35	-	190	640	90	102,0	6,0
		120XH300	TXH3120	7A	-	4040	100	848,93	846,14	-	190	810	90	102,0	6,0

XH 400 - 7/8" (22,225 mm)

Caratteristiche Features Merkmale Características	Codice Code symbol Fabriknummer Code symbole Numero de fabrica	Nostro codice Our code Unser kode Notre code Nuestro codigo	Tipo Type Typ Type Tipo	Codice flangia Flange code Bordscheiben-Code Code flasque Código brida	Bussola Bush Buchse Moyeu Casquillo	Foro max. Max. Bore Max. Bohrung Alesage max. Agujero max.	Dp	De	Df	Dm	Di	F	S	R	Peso Weight / Gewicht Poids / Peso Kg
Ghisa / Cast iron Grauguss / Fonte Hierro fundido	con flangia / with flanges mit Flanges / avec flasques / con tapetas	18XH400	TXH4018	5F	FL155	2517	60	127,34	124,55	140,0	-	95	119	45,0	74,0
		20XH400	TXH4020	5F	FL157	2517	60	141,49	138,69	155,0	-	110	119	45,0	74,0
		22XH400	TXH4022	5F	FL159	2517	60	155,64	152,84	170,0	-	120	119	45,0	74,0
		24XH400	TXH4024	5F	FL161	3020	75	169,79	166,99	184,0	-	135	119	51,0	68,0
		26XH400	TXH4026	5F	FL163	3020	75	183,94	181,14	198,0	-	150	119	51,0	68,0
		28XH400	TXH4028	5F	FL165	3020	75	198,08	195,29	212,0	-	165	119	51,0	68,0
		30XH400	TXH4030	5F	FL167	3020	75	212,23	209,44	227,0	-	180	119	51,0	68,0
		32XH400	TXH4032	5F	FL169	3020	75	226,38	223,59	240,0	-	195	119	51,0	68,0
		40XH400	TXH4040	4WF	FL177	3535	90	282,98	280,18	297,0	160	245	119	89,0	15,0
	senza flangia / without flanges ohne Flanschen / sans flasques sin tapetas	48XH400	TXH4048	9W	-	3535	90	339,57	336,78	-	160	300	119	89,0	15,0
		60XH400	TXH4060	9A	-	4040	100	424,47	421,67	-	190	385	119	102,0	8,5
		72XH400	TXH4072	9A	-	4040	100	509,40	506,56	-	190	470	119	102,0	8,5
		84XH400	TXH4084	9A	-	4040	100	594,25	591,46	-	190	555	119	102,0	8,5
		96XH400	TXH4096	9A	-	4040	100	679,15	676,35	-	190	640	119	102,0	8,5
		120XH400	TXH4120	9A	-	4040	100	848,93	846,14	-	190	810	119	102,0	8,5